

KitchenAid

FOOD GRINDER ATTACHMENT

5KSMFGA

PRODUCT GUIDE



W11533966A

PARTS AND FEATURES

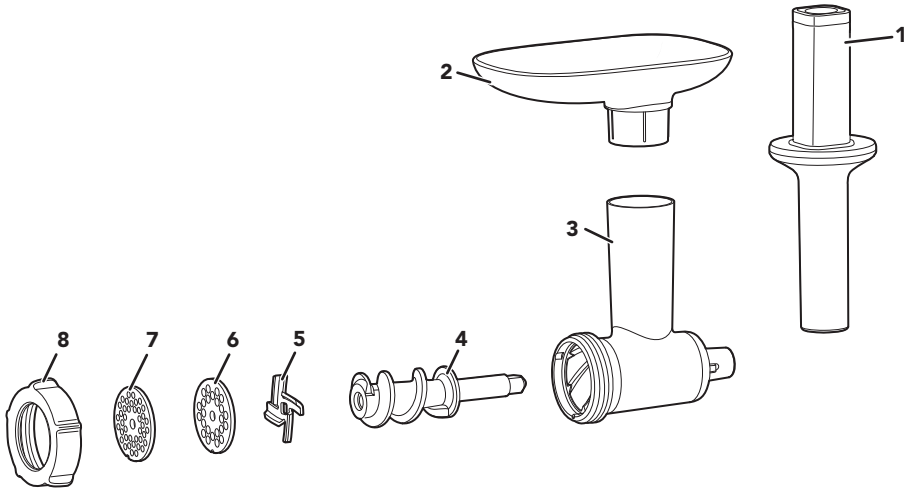

1. Food Pusher
2. Removable Tray
3. Main Housing
4. Grind Screw

5. Blade
6. Coarse (6 mm) Grinding Plate
7. Fine (4.5 mm) Grinding Plate
8. Collar

PRODUCT SAFETY

Your safety and the safety of others are very important.

We have provided many important safety messages in this manual and on your appliance. Always read and obey all safety messages.



This is the safety alert symbol.

This symbol alerts you to potential hazards that can kill or hurt you and others.

All safety messages will follow the safety alert symbol and either the word "DANGER" or "WARNING." These words mean:

 **DANGER**

You can be killed or seriously injured if you don't immediately follow instructions.

 **WARNING**

You can be killed or seriously injured if you don't follow instructions.

All safety messages will tell you what the potential hazard is, tell you how to reduce the chance of injury, and tell you what can happen if the instructions are not followed.

IMPORTANT SAFEGUARDS

When using electrical appliances, basic safety precautions should always be followed, including the following:

1. Read all instructions. Misuse of appliance may result in personal injury.
2. European Union only: Appliances can be used by persons with reduced physical, sensory or mental capabilities or lack of experience and knowledge if they have been given supervision or instruction concerning use of the appliance in a safe way and understand the hazards involved. Children shall not play with the appliance.
3. European Union only: This appliance shall not be used by children. Keep the appliance and its cord out of reach of children.
4. This appliance is not intended for use by persons (including children) with reduced physical, sensory or mental capabilities, or lack of experience and knowledge, unless they have been given supervision or instruction concerning use of the appliance by a person responsible for their safety.
5. Children should be supervised to ensure that they do not play with the appliance.
6. Do not use the appliance outdoors.
7. Turn the appliance OFF (0), unplug from outlet and detach the attachment from the appliance before cleaning and when not in use. Turn the appliance OFF (0) and make sure the motor stops completely before putting on or taking off parts.
8. Check the Main Housing for the presence of foreign objects before using.
9. Avoid contacting moving parts. Keep fingers out of discharge opening.
10. Never leave the appliance unattended while it is in operation.
11. The use of accessories/attachments not recommended by the appliance manufacturer may result in fire, electric shock or injury to persons.

12. Never feed food by hand. Always use the Food Pusher.
13. Do not operate any appliance with a damaged cord or plug, or after the appliance malfunctions, or is dropped or damaged in any manner. Return appliance to the nearest Authorised Service Facility for examination, repair, or electrical or mechanical adjustment.
14. Do not let the cord hang over the edge of table or counter.
15. Blades are sharp. Handle carefully.
16. Refer to the "Care and Cleaning" section for instructions on cleaning the surfaces in contact with food.
17. Also see the Important Safeguards section included in the Stand Mixer Owner's Manual.
18. Allow the appliance to cool completely before putting on or taking off parts, and before cleaning the appliance.
19. This appliance is intended to be used in household and similar applications such as:
 - staff kitchen areas in shops, offices and other working environments;
 - farmhouses;
 - by clients in hotels, motels and other residential type environments;
 - bed and breakfast type environments.

SAVE THESE INSTRUCTIONS

For complete details on product information, instructions and videos, including Guarantee information, visit www.KitchenAid.co.uk or www.KitchenAid.eu. This may save you the cost of a service call. To receive a free printed copy of the information online, call **00 800 381 040 26**.

GETTING STARTED

GUIDE TO GRINDING

NOTE: None of the parts and accessories of this KitchenAid Food Grinder Attachment (model 5KSMFGA) are compatible with the parts and accessories of the KitchenAid Metal Food Grinder Attachment or previous KitchenAid Food Grinder Attachment (models 5KSMMGA, 5FGA, 5SSA, 5FVSP, 5FVSFGA, 5FPPA, 5KSMFPPA, 5GSSA, 5KSMGSSA, 5KN12AP) and vice versa.

USE THESE PARTS	WITH THESE PARTS	SUGGESTED USES	SPEED
Fine (4.5 mm) Grinding Plate	Blade	Cooked meats for spreads, hard cheeses (e.g. Parmesan), bread crumbs	4
Coarse (6 mm) Grinding Plate	Blade	Raw meats for burgers and chili, vegetables for salsas and sauces	4

PRODUCT ASSEMBLY

Before first use

Before using your Food Grinder Attachment for the first time, wash all parts and accessories either by hand or in the dishwasher (see the "Care and Cleaning" section).

ASSEMBLING THE ATTACHMENT

1. Insert the Grind Screw into the Main Housing securely.
2. Place the Blade over the end of the Grind Screw.

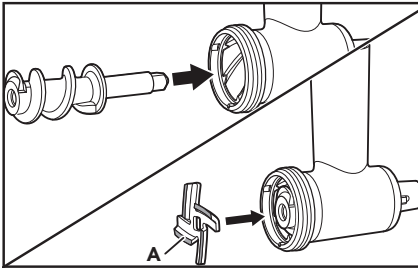

A. Sharp Side

3. Place the desired Grinding Plate over the Blade, matching the notch of the plate with the tab on the bottom of the Main Housing.
4. Place the Collar on the Main Housing, turning clockwise by hand until secured but not tightened.

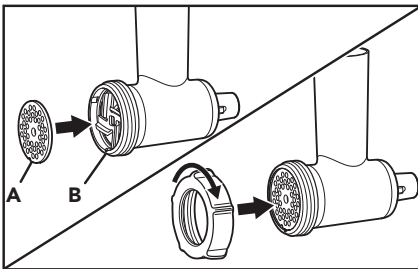

A. Notch
B. Tab

ASSEMBLING THE ATTACHMENT TO THE STAND MIXER

1. Turn the Stand Mixer OFF (0) and unplug.

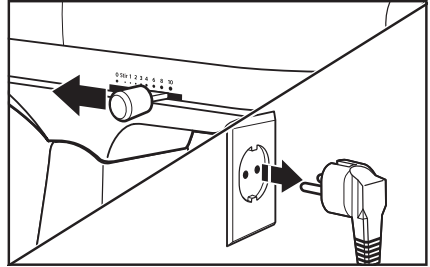

2. For Stand Mixers with a hinged power hub cover: Flip up to open.

For Stand Mixers with a removable power hub cover: Turn the attachment knob counterclockwise to remove power hub cover.

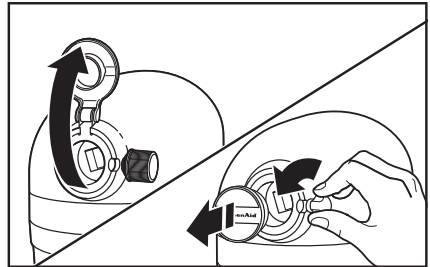

3. Remove the Stand Mixer Attachment Hub cover.
4. Insert the attachment shaft housing into the Attachment Hub.

NOTE: Removable Tray can be used as per convenience.

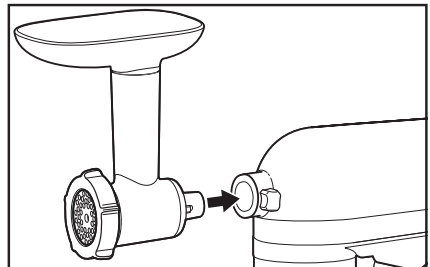

5. Tighten the Stand Mixer Attachment Hub knob until the attachment is completely secured to the Stand Mixer.

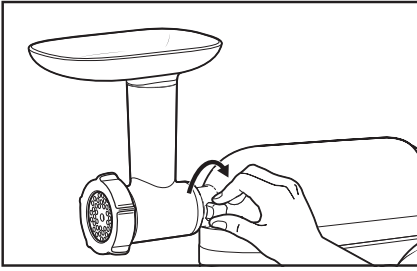

PRODUCT USAGE

USING WITH THE FOOD GRINDER ATTACHMENT

⚠ WARNING

Rotating Blade Hazard



- Always use food pusher.
- Keep fingers out of openings.
- Keep away from children.
- Failure to do so can result in amputation or cuts.

1. Cut food into small strips or pieces sized to fit into the feed tube.
2. Turn the Stand Mixer to Speed 4 and feed food into the feed tube using the Food Pusher.

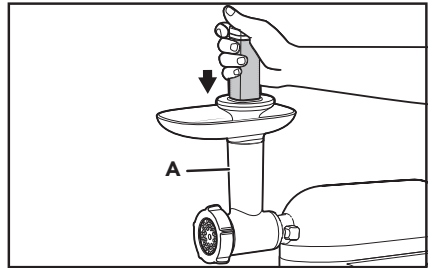
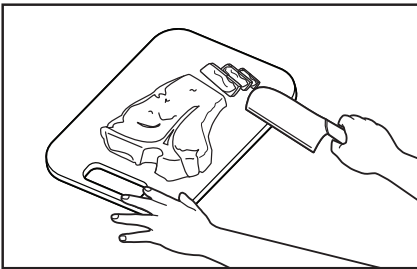

A. Feed Tube

CARE AND CLEANING

NOTE: Blades are sharp. Handle carefully.

- 1. Dishwasher-safe parts, top rack only:**
Collar, Removable Tray and Food Pusher.

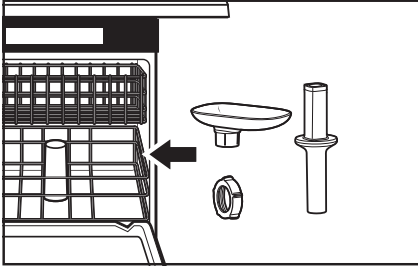

- 2. The following parts should be hand-washed only, using warm, soapy water and drying thoroughly:** Main Housing, Grind Screw, Grinding Plates and Blade.

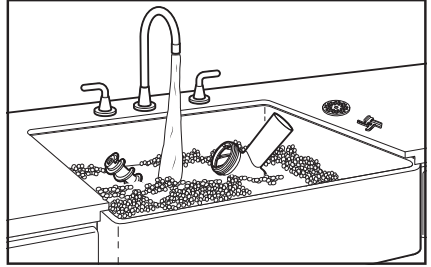

DECLARATION OF CONFORMITY

FOR UNITED KINGDOM

This appliance has been designed, constructed and distributed in compliance with the safety requirements of UK Legislation: Electrical Equipment (Safety) Regulations 2016, The Ecodesign for Energy-Related Products and Energy Information (Amendment) (EU Exit) Regulations 2019. The Restriction of the Use of Certain Hazardous Substances in Electrical and Electronic Equipment Regulations 2012.

FOR EUROPEAN UNION

This appliance has been designed, constructed and distributed in compliance with the safety requirements of EC Directives: 2014/35/EU, 2014/30/EU and 2011/65/EU (RoHS Directive) and following amendments.

TERMS OF KITCHENAID GUARANTEE ("GUARANTEE")

Covering U.K. - Ireland - South Africa - UAE

KitchenAid Europa, Inc., Nijverheidslaan 3, Box 5, 1853 Strombeek-Bever, Belgium ("Guarantor") grants the end-customer, who is a consumer, a Guarantee pursuant to the following terms.

FOR U.K.:

The Guarantee applies in addition to and does not limit or affect the statutory warranty rights of the end-customer against the seller of the product. In summary, the Consumer Rights Act 2015 says products must be as described, fit for purpose and of satisfactory quality. During the expected lifespan of your product your legal rights entitle you to the following:

- Up to 30 days: if your product is faulty, then you can get an immediate refund.
- Up to six months: if your product can't be repaired or replaced, then you're entitled to a full refund, in most cases.
- Up to six years: if your product does not last a reasonable length of time you may be entitled to some money back.

These rights are subject to certain exceptions. For detailed information please visit the Citizens Advice website www.adviceguide.org.uk or call **03454 04 05 06**.

FOR IRELAND:

The Guarantee applies in addition to and does not limit or affect the statutory warranty rights of the end-customer against the seller of the product under the European Communities (Certain Aspects of the Sale of Consumer Goods and Associated Guarantees) Regulations 2003 (S.I. No. 11/2003) and other enactments governing the sale of consumer goods.

FOR SOUTH AFRICA:

The Guarantee applies in addition to and does not limit or affect the statutory warranty rights of the end-customer against the seller of the product. In summary, the Consumer Protection Act, 2008 says that products must be: (i) reasonably suitable for the purpose for which they are intended; (ii) in good working order, of good quality and free of any defects; (iii) useable and durable for a reasonable period of time, having regard to the use to which they would normally be put and to all the surrounding circumstances; and (iv) in compliance with any applicable standards or any other public regulations.

During the expected lifespan of your product and where the products are not purchased online, your legal rights will entitle you to the following:

- You will be entitled to a full refund, if you did not have the opportunity to examine the product before delivery and if you rejected delivery of the product on the basis that the type and quality of the product was not as reasonably expected or did not reasonably conform to the material specifications.
- Within 5 business days after delivery: you may rescind your purchase and request a refund, if your purchase resulted from direct marketing.
- Within 10 business days after delivery: you will be entitled to a full refund, if it is found that the product was unsuitable for a particular purpose specifically communicated to you by the Guarantor.
- Within 15 business days after delivery: you will be entitled to a refund if: (i) the product was not delivered to you; or (ii) if you returned the product to the Guarantor.
- Within 6 months after delivery: you will be entitled to a refund or a replacement product, if the product is defective or fails to operate in terms of its specifications.

Where you have purchased a product online your legal rights will be governed by the Electronic Communications and Transactions Act, 2002 and you will be entitled to the following:

- Within 7 days after conclusion of the transaction or after delivery: you may cancel your purchase without reason and without penalty.
- Within 30 days of the date of cancellation of the transaction: you will be entitled to receive a refund, if you have already made payment.
- You will only be liable for the direct costs of returning the product to the Guarantor.

FOR UAE:

The Guarantee applies in addition to and does not limit or affect the statutory warranty rights of the end-customer against the seller of the product.

1. SCOPE AND TERMS OF THE GUARANTEE

- a) The Guarantor grants the Guarantee for the products mentioned under Section 1.b) which a consumer has purchased from a seller or a company of the KitchenAid-Group within the following countries: U.K., Ireland, or South Africa, or the United Arab Emirates (UAE).
- b) The Guarantee period depends on the purchased product and is as follows:
Two Year full guarantee from date of purchase.
- c) The Guarantee period commences on the date of purchase, i.e. the date on which a consumer purchased the product from a dealer or a company of the KitchenAid-Group.
- d) The Guarantee covers the defect-free nature of the product.
- e) The Guarantor shall provide the consumer with the following services under this Guarantee, at the choice of the Guarantor, if a defect occurs during the Guarantee period:
 - Repair of the defective product or product part, or
 - Replacement of the defective product or product part. If a product is no longer available, the Guarantor is entitled to exchange the product for a product of equal or higher value.

- f) If the consumer wishes to make a claim under the Guarantee, the consumer has to contact the country specific KitchenAid service centres or the Guarantor directly at KitchenAid Europa, Inc. Nijverheidslaan 3, Box 5, 1853 Strombeek-Bever, Belgium;
Email-Address U.K.: CONSUMERCARE.UK@kitchenaid.eu
Email-Address IRELAND: CONSUMERCARE.IE@kitchenaid.eu
Toll Free Number U.K. & IRELAND: **00 800 381 040 26**

FOR SOUTH-AFRICA:

Our local KitchenAid Distributor:

KitchenAid Africa
PO Box 52102
V&A Waterfront
Cape Town
8002

Contact our distributor:

Telephone: +27 21 555 0700

You can contact our Customer Service Centre for Small Domestic Appliances from 8.30 am to 1.00 pm and from 1.30 pm to 5.00 pm or write to us at the following address: hello@kitchenaidafrica.com

FOR UAE:

AL GHANDI ELECTRONICS.

POST BOX NO. 9098,
DUBAI, UNITED ARAB EMIRATES
Toll free number: +971 4 2570007

- g) The costs of repair, including spare parts, and any postage costs (if applicable) for the delivery of a defect-free product or product part shall be borne by the Guarantor. The Guarantor shall also bear the postage costs for returning the defective product or product part if the Guarantor or the country specific KitchenAid customer service centre requested the return of the defective product or product part. However, the consumer shall bear the costs of appropriate packaging for the return of the defective product or product part.
- h) To be able to make a claim under the Guarantee, the consumer must present the receipt or invoice of the purchase of the product.

2. LIMITATIONS OF THE GUARANTEE

- a) The Guarantee applies only to products used for private purposes and not for professional or commercial purposes.
- b) The Guarantee does not apply in the case of normal wear and tear, improper or abusive use, failure to follow the instructions for use, use of the product at the wrong electrical voltage, installation and operation in violation of the applicable electrical regulations, and use of force (e.g. blows).
- c) The Guarantee does not apply if the product has been modified or converted, e.g. conversions from 120 V products to 220-240 V products.
- d) The provision of Guarantee services does not extend the Guarantee period, nor does it initiate the commencement of a new Guarantee period. The Guarantee period for installed spare parts ends with the Guarantee period for the entire product.
- e) **FOR SOUTH-AFRICA & UAE ONLY:**
Further or other claims, in particular claims for damages, are excluded unless liability is mandatory by law.

After expiry of the Guarantee period or for products for which the Guarantee does not apply, the KitchenAid customer service centres are still available to the end-customer for questions and information.

Further information is also available on our website:

- For U.K. & Ireland www.kitchenaid.eu
- For South-Africa: www.kitchenaidafrica.com
- For UAE: www.KitchenAid-MEA.com

PRODUCT REGISTRATION

Register your new KitchenAid appliance now: <http://www.kitchenaid.eu/register>

KitchenAid

©2021 All rights reserved.

KITCHENAID and the design of the stand mixer are trademarks in the U.S. and elsewhere.