

**THANK YOU FOR BUYING A INDESIT PRODUCT**

In order to receive a more complete assistance, please register your product on [www.indesit.com/register](http://www.indesit.com/register)



**Before using the appliance carefully read the Safety Instruction.**

Before using the machine, it is imperative that the transport bolts are removed. For more detailed instructions on how to remove them, see the Installation Guide.

**CONTROL PANEL**

1. ON/OFF button
2. START/PAUSE button and indicator light
3. TEMPERATURE button
4. DISPLAY
5. CHILD LOCK button
6. OPTION button
7. DELAYED START button
8. SPIN button
9. WASH CYCLE SELECTOR KNOB
10. PUSH & WASH button

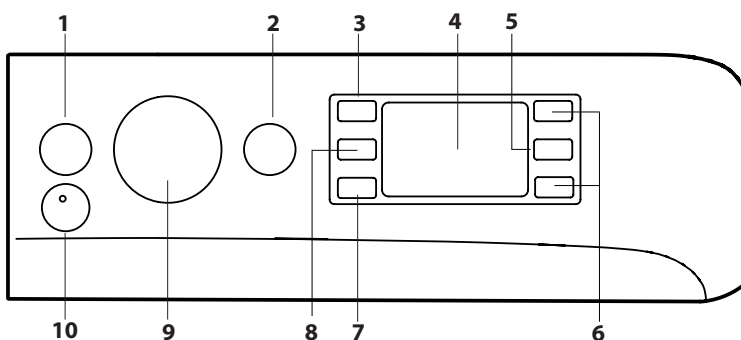

**WASH CYCLE TABLE**

Maximum load 9 kg Power input in off mode 0,5 W / in left-on mode 8 W						Detergents and Additives		Recommended detergent		Residual dampness %	Energy consumption kWh	Total water l	
Wash cycle	Temperature		Maximum spin (r.p.m.)	Maximum load (kg)	Duration (minutes)	Wash	Fabric softener	Powder	Liquid				
	Default	Range				2	3						
1	<b>Daily cotton</b>	30°C	☼ - 30°C	1200	4.5	**	●	○	-	✓	-	-	-
2	<b>Daily synthetics</b>	30°C	☼ - 30°C	1000	4.5	**	●	○	-	✓	-	-	-
3	<b>Coloureds</b>	30°C	☼ - 30°C	1000	4.5	**	●	○	-	✓	-	-	-
4	<b>Delicates</b>	30°C	☼ - 30°C	0	1,0	**	●	○	-	✓	-	-	-
5	<b>Rapid 30min</b>	30°C	☼ - 30°C	800	4.5	30	●	○	-	✓	70	0,18	42
6	<b>Cotton (2)</b>	40°C	☼ - 60°C	1400	9,0	235	●	○	✓	✓	53	1,1	97
7	<b>Synthetics (3)</b>	40°C	☼ - 60°C	1000	4.5	125	●	○	✓	✓	46	0,74	59
8	<b>Mixed</b>	40°C	☼ - 40°C	1400	9,0	**	●	○	-	✓	-	-	-
9	<b>Eco cotton</b> ◻ (1)	60°C	60°C	1400	9,0	250	●	○	✓	✓	53	1,03	57,4
			40°C	1400	9,0	235	●	○	✓	✓	53	1,1	97
10	<b>White cotton</b>	60°C	☼ - 90°C	1400	9,0	**	●	○	✓	✓	-	-	-
11	<b>Sport</b> --- 🧥	30°C	☼ - 40°C	600	4,0	**	●	○	✓	✓	-	-	-
12	<b>Duvet</b>	30°C	☼ - 30°C	1000	3.5	**	●	○	-	✓	-	-	-
13	<b>Wool</b>	40°C	☼ - 40°C	800	2,0	**	●	○	-	✓	-	-	-
14	<b>Anti odour</b>	40°C	☼ - 40°C	1000	3.5	**	●	○	-	✓	-	-	-
🌀	<b>Rinse + Spin</b>	-	-	1400	9,0	**	-	○	-	-	-	-	-
🌀	<b>Spin + Drain *</b>	-	-	1400	9,0	**	-	-	-	-	-	-	-

● Required dosage    ○ Optional dosage

The cycle duration indicated on the display or instruction manual is an estimate based on standard conditions. The actual duration may vary in relation to several factors, such as the temperature and pressure of the incoming water, ambient temperature, amount of detergent, load quantity and type, load balancing and any additional options selected.

**1) Test wash cycle in compliance with regulation 1061/2010:**

This cycle is designed for normally soiled cotton loads and is the most efficient in terms of both electricity and water consumption; it should be used for garments washable at 60°C or at 40°C. The actual washing temperature may differ from the indicated value.

**For all testing institutes:**

- 2) Long cotton cycle: set cycle 6 at a temperature of 40°C.
- 3) Long synthetics cycle: set cycle 7 at a temperature of 40°C.

\* By selecting the 🌀 cycle and excluding the spin cycle, the washing machine will drain only.

\*\* The duration of the wash cycles can be checked on the display.

**PRODUCT DESCRIPTION**

1. Top
2. Detergent dispenser drawer
3. Control panel
4. Handle
5. Porthole door
6. Drain pump (behind the plinth)
7. Plinth (removable)
8. Adjustable feet (2)

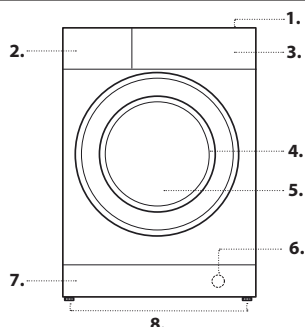

**DETERGENT DISPENSER DRAWER**

**Compartment 1:**

Do not insert detergent in this compartment.  
**Compartment 2: Washing detergent (powder or liquid)**

If liquid detergent is used, the removable plastic partition **A** (supplied) should be used for proper dosage. If powder detergent is used, insert the partition into slot **B**.  
**Compartment 3: Additives (fabric softener, etc.)**

The fabric softener must never exceed the "max" level indicated on the central pin.

! Use powder detergent for white cotton garments, for pre-washing, and for washing at temperatures over 60°C.

! Follow the instructions given on the detergent packaging.

! To remove the drawer, press lever **C** and pull the drawer outwards.

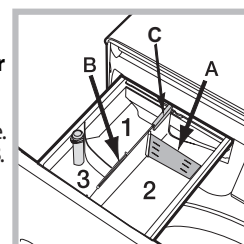

## WASH CYCLES

Follow the instructions on the symbols of the garment's wash care label. The value indicated in the symbol is the maximum recommended temperature for washing the garment.

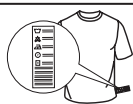

### Daily cotton

A 30°C cycle for cotton garments. It allows for reducing electricity consumption for heating the water while guaranteeing good washing performance. Suitable for lightly soiled garments.

### Daily synthetics

A 30°C cycle for synthetic garments. It allows for reducing electricity consumption for heating the water while guaranteeing good washing results. Suitable for lightly soiled garments.

### Coloureds

A 30°C cycle that helps to preserve colours, suitable for cotton or synthetic coloured garments. It allows for reducing electricity consumption for heating the water while guaranteeing good washing results. Suitable for lightly soiled garments.

### Delicates

Suitable for washing very delicate garments. It is advisable to turn the garments inside out before washing them. For best results, use liquid detergent on delicate garments.

### Rapid 30min

For washing lightly soiled garments in a short time. Not suitable for wool, silk and garments to be washed by hand.

### Cotton

Suitable for washing towels, underwear, table cloths, etc. made of resistant linen and cotton that are moderately to heavily soiled.

### Synthetics

Suitable for washing moderately soiled garments made of synthetic fibres (e.g. polyester, polyacrylic, viscose, etc.) or mixed synthetic-cotton fibres.

### Mixed

A 40°C cycle for washing cotton and synthetic garments together. Suitable for lightly soiled underwear.

### Eco Cotton

Suitable for washing moderately soiled cotton garments. At 40°C and 60°C it is the standard cycle for washing cotton garments, and is the most efficient in terms of combined water and electricity consumption.

### White cotton

For heavily soiled whites and resistant colours.

### Sport

Is designed for washing lightly soiled sports clothing (tracksuits, shorts, etc.); for best results, we recommend not exceeding the maximum load indicated in the "Programme table". We recommend using liquid detergent, and adding the amount suitable for a half-load

### Duvet

For washing clothing padded with goose down, such as double or single duvets (weighing under 3.5 kg), cushions or down jackets. Duvets should be loaded into the drum with their edges folded inwards and no more than ¾ of the total drum volume should be used up. For best results, it is advisable to use liquid detergent to be poured into the detergent drawer.

### Wool - Woolmark Apparel Care - Blue:

The "Wool" wash cycle is approved by the Woolmark Company for washing wool garments classified as "hand-washable", provided that the wash complies with the instructions appearing on the garment's label and with those provided by the manufacturer of this washing machine. (M1127)



### Anti odour

Use this cycle (for synthetic fabrics) to wash garments with bad odours (e.g. smoke, sweat, fried food). The cycle is designed to remove bad odours while preserving the fabric fibres.

### Rinse + Spin

Designed for rinsing and spinning.

### Spin + Drain

Designed to spin and drain the water.

## DISPLAY

The display is useful when programming the machine and provides a lot of information.

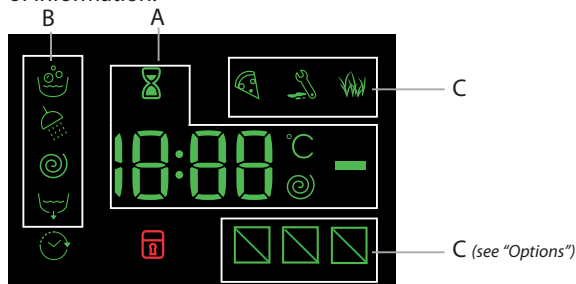

The duration of the available wash cycles and the remaining time of a running cycle appear in section **A**; if the Delayed Start option has been set, the countdown to the start of the selected cycle will appear. Pressing the corresponding button allows for viewing the maximum spin

speed and temperature values attained by the machine during the set wash cycle, or the values selected most recently, if these are compatible with the set wash cycle.

The hourglass flashes while the machine processes the data on the basis of the selected cycle. After a maximum of 10 minutes, the hourglass icon remains steady lit and the final time remaining is displayed. The "hourglass" icon will then switch off approximately 1 minute after the final time remaining has been displayed.

The "washing phases" relative to the selected cycle and the "washing phase" of the running cycle appear in section **B**:



When lit, the symbol indicates that the set "Delayed Start" value has appeared on the display.

There are three levels in section **C** relative to the washing options.

### Door locked indicator

When lit, the symbol indicates that the door is locked. To prevent any damage, wait until the symbol turns off before opening the door. To open the door while a cycle is in progress, press the START/PAUSE button; if the symbol is off, the door can be opened.

## FIRST-TIME USE

Once the appliance has been installed, and before it is used for the first time, run a wash cycle with detergent and no laundry, by setting the "Auto-Clean" cycle.

## DAILY USE

Prepare the laundry by following the suggestions appearing under the "TIPS AND SUGGESTIONS" section.

### Rapid programming

- Open the door. Load the laundry while making sure not to exceed the maximum load quantity indicated in the cycle table.
- Pull out the detergent dispenser drawer and pour the detergent into the relevant compartments as described in "DETERGENT DISPENSER DRAWER" section.
- Close the door.
- Press the PUSH & WASH button to start the wash cycle.

### Traditional programming

- Press the ON/OFF button; the START/PAUSE indicator light will flash slowly green.
- Open the door. Load the laundry while making sure not to exceed the maximum load quantity indicated in the Wash Cycle Table.
- Pull out the detergent dispenser drawer and pour the detergent into the relevant compartments as described in "DETERGENT DISPENSER DRAWER" section.
- Close the door.
- Use the WASH CYCLE selector knob to select the desired wash cycle: it will be associated with a specific temperature and spin speed that can be modified. The duration of the cycle will appear on the display.
- Modify the temperature and/or spin speed: the machine automatically displays the maximum temperature and spin speed values set for the selected cycle, or the most recently-used settings if they are compatible with the selected cycle. Pressing the button gradually reduces the temperature down to the cold wash "OFF" setting. Pressing the button gradually reduces the spin speed until it is completely excluded ("OFF" setting). Pressing these buttons again restores the maximum values.
- Select the desired options.
- Press the START/PAUSE button to start the wash cycle; the relative indicator light will light up steady green and the door will lock (symbol on).

## PAUSING A CYCLE

To pause the wash cycle, press the START/PAUSE button again; the indicator light will flash amber. If the symbol is not lit, the door may be opened. To start the wash cycle from the point at which it was interrupted, press the START/PAUSE button again.

## OPENING THE DOOR, IF NECESSARY

Once a cycle starts, the symbol turns on to signal that the door cannot be opened. While a wash cycle is running, the door remains locked. To open the door while a cycle is under way, for example, to add or remove garments, press the START/PAUSE button to pause the cycle; the indicator light will flash amber. If the symbol is not lit, the door may be opened. Press the START/PAUSE button again to continue the cycle.

## CHANGING A RUNNING WASH CYCLE

To change a wash cycle while it is in progress, pause the washing machine using the START/PAUSE button (the relative indicator light will flash amber), then select the desired cycle and press the START/PAUSE button again. ! To cancel a cycle that has already begun, press and hold the ON/OFF button. The cycle will be stopped and the machine will switch off.

## END OF THE CYCLE

This will be indicated by the word "END" on the display; when the symbol switches off, the door may be opened. Open the door, unload the



laundry and switch off the machine. If you do not press "ON/OFF" (⏻) button, the washing machine will switch off automatically after about a half of an hour. Close the water tap, open the door and unload the washing machine. Leave the door ajar to allow the drum to dry.

## OPTIONS

- If the selected option is not compatible with the set wash cycle, the indicator light will flash and the option will not be activated.
- If the selected option is not compatible with another previously selected option, the indicator light will flash accompanied by a buzzer (3 beeps), and only the latter option will be activated; the indicator light corresponding to the activated option will turn on.

### Stain removal

This option allows for selecting the type of dirt so as to optimally adjust the cycle for removing the stains. The following types of dirt can be selected:

-  **Food:** for stains caused by foodstuffs and beverages, for example.
-  **Work:** for grease and ink stains, for example.
-  **Outdoor:** for mud and grass stains, for example.

! The wash cycle duration varies according to the type of selected dirt.

### Sport

This option allows for selecting the most suitable programme for any type of sports clothing, and is designed to remove dirt while optimally preserving the technical features of the garments. The various Sport option levels offer the following wash cycles:

 - **Sport Shoes**, a cycle designed to safely wash up to 2 pairs of sports shoes simultaneously.

 - **Gym Kit**, a cycle designed to simultaneously wash any type of sports clothing together with gym towels.

 - **Technical Wear**, designed for specifically washing waterproof garments or clothing with special technical fibres like Gore-Tex, so as to optimise washing performance while preserving their technical properties over time. Do not use fabric softeners for garments with technical fibres.

### Delayed Start

To set a delayed start for the selected cycle, press the corresponding button repeatedly until the desired delay period has been reached. When this option has been activated, the  symbol lights up on the display. To remove the delayed start setting, press the button until the word "OFF" appears on the display.

### Temperature

Each wash cycle has a pre-defined temperature. To modify the temperature, press the  button. The value will appear on the display.

### Spin

Each wash cycle has a pre-defined spin speed. To modify the spin speed, press the  button. The value will appear on the display.

### Push & Wash

This function allows for starting a wash cycle even when the machine is switched off without having to press the ON/OFF (⏻) button in advance or, after switching the machine on, without having activated any other button and/or selector knob (otherwise the Push & Wash cycle will be deactivated). To start the Push & Wash cycle press and hold the relative button for 2 seconds. The lit indicator light indicates that the cycle has started. This wash cycle is ideal for cotton or synthetic fabrics, as it washes at a temperature of 30°C and a maximum spin speed of 1,000 rpm. Max load 4 kg (cycle duration 45').

*How does it work?*



1. Load the laundry (cotton and/or synthetic garments) and close the door.
2. Pour the detergent and additives.
3. Start the cycle by pressing and holding the Push & Wash button for 2 seconds. The relevant indicator light will turn green and the door will lock (the  symbol lights up).

N.B.: starting the wash cycle through the Push & Wash button activates an automatic non-customisable cycle recommended for cotton and synthetic fabrics. This cycle does not allow for setting any additional options.

To open the door while an automatic cycle is under way, press the START/PAUSE (▶||) button; if the locked door symbol  is off, the door may be opened. Press the START/PAUSE (▶||) button again to restart the cycle from the point at which it was interrupted.

4. At the end of the wash cycle the word END will appear on the display.

### CHILD LOCK

To activate the control panel lock, press and hold the  button for approximately 2 seconds. The lit  symbol signals that the control panel is locked. This prevents wash cycles from being modified accidentally (except for the ON/OFF (⏻) button), especially if there are children in the home. To deactivate the control panel lock, press and hold the  button for approximately 2 seconds.

## TIPS AND SUGGESTIONS

### Divide the laundry according to:

Type of fabric (cotton, mixed fibres, synthetics, wool, garments to be hand-washed). Colour (separate coloured garments from whites, wash new coloured garments separately). Delicates (small garments – such as nylon stockings – and items with hooks – such as bras: insert them in a fabric bag).

### Empty the pockets:

Objects such as coins or lighters can damage the washing machine and the drum. Check all buttons.

## CARE AND MAINTENANCE

*Before performing cleaning and maintenance, switch the washing machine off and disconnect it from the mains power. Do not use flammable liquids to clean the washing machine.*



### Disconnect the water and power supplies

Close the water tap after every wash. This will limit wear on the hydraulic system inside the washing machine and help to prevent leaks. Unplug the washing machine when cleaning it and during all maintenance work.

### Clean the washing machine

The outer parts and rubber components of the appliance can be cleaned using a soft cloth soaked in lukewarm soapy water. Do not use solvents or abrasives.

The washing machine has a "Auto-cleaning" cycle for its internal parts; it must be run without any load in the drum.

To optimise this cycle, it is possible to use either detergent (10% of the quantity specified for lightly soiled garments) or special additives to clean the washing machine. We recommend running a cleaning cycle every 40 wash cycles. To start the cycle press buttons  and **11**  simultaneously for 5 seconds.

The cycle will start automatically and will run for about 70 minutes. To stop the cycle, press the START/PAUSE (▶||) button.

### Clean the detergent dispenser drawer

Wash it under running water; this operation should be repeated frequently.

### Care for the door and drum

Always leave the porthole door ajar in order to prevent unpleasant odours from forming.

### Clean the pump

The washing machine is fitted with a auto-cleaning pump that does not require any maintenance. Small items (such as coins or buttons) may sometimes fall into the protective pre-chamber situated at the base of the pump.

! Make sure the wash cycle has ended and unplug the appliance.

To access the pre-chamber:

1. remove the cover panel on the front of the machine by first pressing it in the centre then pushing downwards on both sides to extract it;
2. loosen the drainage pump cover by turning it anti-clockwise: it is normal for some water to leak out;
3. clean the inside thoroughly;
4. screw the cover back on;
5. put the panel back in place, making sure the hooks slot in place before pushing the panel onto the appliance.

### Check the water inlet hose

Check the water inlet hose at least once a year. If it is cracked or broken, it must be replaced: during wash cycles, the high pressure of the water could suddenly split the hose open.

! Never use hoses that have already been used.

## LOAD BALANCING SYSTEM

Before every spin cycle, to avoid excessive vibrations before every spin and to distribute the load in a uniform manner, the drum rotates continuously at a speed which is slightly greater than the washing rotation speed. If, after several attempts, the load is not balanced correctly, the machine spins at a reduced spin speed. If the load is excessively unbalanced, the washing machine performs the distribution process instead of spinning. To encourage improved load distribution and balance, we recommend small and large garments are mixed in the load.

## ACCESSORIES

*Contact our Technical Assistance Service to check whether the following accessories are available for this washing machine model.*

### Stacking kit

With this accessory you can secure the tumble dryer to the upper part of your washing machine to save space and facilitate loading and unloading of the tumble dryer.

## TRANSPORT AND HANDLING

*Do not lift the washing machine by gripping it from the upper section.* Unplug the appliance and close the water tap. Check that the door and detergent dispenser drawer are tightly closed. Detach the filling hose from the water tap then detach the drain hose. Empty all the water remaining in the hoses and secure the latter so that they do not get damaged during transport. Apply the transport bolts back on. Repeat, in reverse order, the transport bolt removal procedure described in the "Health & Safety and Installation Guides".

*Important: Not emptying contents from pockets may cause pump or drain blockages, or may damage the machine.*





*Do not wash items which do not have a wash label, or wash items that are not intended as machine washable.*

*DEMO MODE: to deactivate this function, switch the washing machine OFF. Then press and hold "Start/Pause" (▶||) button, within 5 seconds press also "ON/OFF" (⏻) button and hold both buttons for 2 seconds.*



## TROUBLESHOOTING

Your machine could occasionally fail to work. Before contacting the Technical Assistance Service, make sure that the problem cannot be easily solved using the following list.

Anomalies	Possible causes / Solution
<b>The machine does not switch on.</b>	The appliance is not plugged into the socket fully, or not enough to make contact.
	There is no power to the socket, or the fuse has blown in the mains plug.
<b>The wash cycle does not start.</b>	The door is not closed properly.
	The ON/OFF  button has not been pressed.
	The START/PAUSE  button has not been pressed.
	The water tap has not been turned on to allow water to flow into the machine.
	A delayed start has been set.
<b>The machine does not fill with water ("H2O" appears on the display).</b>	The water inlet hose is kinked.
	The water inlet hose is not connected to the water supply.
	The water pressure is too low.
	The water tap has not been turned on to allow water to flow into the machine.
	There is no water supply to the house.
	The inlet valve filter is blocked.
	The START/PAUSE  button has not been pressed.
<b>The machine continuously fills with water and continually drains away or Water left in the drum or Stuck on wash.</b>	The top of the drain hose is too low - It must be fitted at a height between 65 and 100 cm from the floor.
	The drain hose is connected incorrectly to the sink trap allowing water to run into the machine, the drain hose must be positioned higher than the bottom of the sink to prevent water flowing down the drain hose.
	The end of the drain hose has been pushed too far down the standpipe, the 'U' bracket should be fitted 100 mm from the end of the drain hose.
<b>The machine does not drain or spin - (error lights flashing).</b>	The Pump filter is blocked.
	The drain hose is kinked.
	New Installation - The blanking cap or spigot has not been removed if connected under a sink.
	The drain hose or sink trap is blocked.
<b>The machine does spin.</b>	The 'Spin' Speed is set to "OFF".
<b>The machine does not heat or poor wash results.</b>	The 'Temperature' is set to "OFF".
<b>The programme takes too long.</b>	Programme times will vary due to water pressure, the incoming water temperature and if the wash load goes out of balance. This will increase the programme times accordingly.
<b>The Display sticks at one 'time to end' for more than 1 Minute or the Display changes the estimated 'Time to End' during the programme.</b>	The display time is for guidance only - it is not a precise time to finish and may vary.
<b>The washing machine vibrates a lot during the spin cycle.</b>	The feet have not been adjusted, enabling the machine to rock.
	New Installation - Either the Transit Bolts including the plastic spacers, or the Polystyrene Packaging have not been removed when installing the machine.
	The machine is trapped between cabinets and/or walls.
	The load is in a slight out of balance condition and machine is spinning, but at a lower speed.
<b>The machine is noisy.</b>	There will always be some motor, pump and drum noise during spin.
<b>The machine leaks from the dispenser.</b>	The dispenser drawer is blocked with detergent and requires cleaning.
	The water pressure is too high and requires turning down - turn down the tap on the water supply pipe slightly and try again.
	The machine is tilting forwards - It must be level when in its final position.
<b>The "Options" and START/PAUSE  indicator lights flash rapidly and the display visualises an error code (e.g.: F-01, F-...).</b>	Switch off the machine and unplug it, wait for approximately 1 minute and then switch back on again. If the problem persists contact Technical Assistance Centre.
<b>The machine smells.</b>	The machine requires a service wash. Run a auto clean wash cycle with detergent and no laundry.
<b>The water level is too low when the machine is washing.</b>	The water level is correct if it can be seen at the bottom of the door.
<b>There is too much foam.</b>	The detergent is not suitable for machine washing (it should display the text 'for washing machines' or 'hand and machine wash' or the like).
<b>General.</b>	Your washing machine contains sensors that monitor progress during the wash cycle (eg: Water Levels, Temperatures, Out of Balance loads, Wash time/progress). Normally, if your machine successfully completes the cycle, there is unlikely to be anything wrong!
<b>The Push &amp; Wash function does not activate.</b>	After switching on the machine, a control other than Push & Wash was activated. Switch the machine off and press the Push & Wash button.



You can download the **Safety Instructions, User Manual, Product Fiche and Energy data** by:

- Visiting our website - <http://docs.indesit.eu>
- Using QR Code
- Alternatively, **contact our After-sales Service** (See phone number in the warranty booklet). When contacting our After-sales Service, please state the codes provided on your product's identification plate.

