

KCBFS 18602 (UK) 2

12NC: 859991619230

GTIN (EAN) code: 8003437047091

KitchenAid

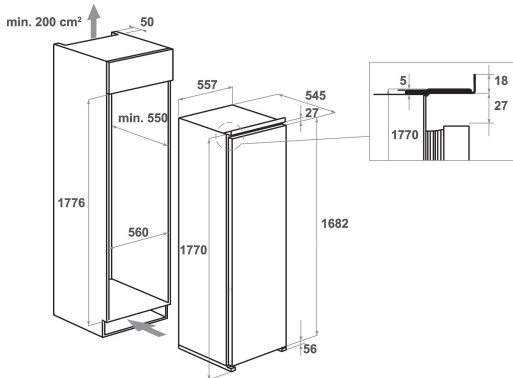

MAIN FEATURES

Product group	Freezer
Commercial code	KCBFS 18602 (UK) 2
GTIN (EAN) code	8003437047091
Construction type	Built-in
Installation type	Full-integrated
Type of control	Electronic
Main colour of product	White
Electrical connection rating (W)	130
Current (A)	13
Voltage (V)	220-240
Frequency (Hz)	50
Length of Electrical Supply Cord (cm)	200
Plug type	UK
Total volume of the product (EU 2017/1369)	203
Height of the product	1771
Width of the product	557
Depth of the product	545
Maximum adjustability feet	0
Net weight (kg)	58
Gross weight (kg)	60
Door hinge	-

TECHNICAL FEATURES

Defrost process	Frost-free
Fast freezing function (EU 2017/1369)	Yes
Refrigerator section with thaw water drainage system	Yes
Number of drawers/baskets	8
Lockable door	No
Thermometer freezer section	N/A
Interior light	-

PERFORMANCES

Energy Efficiency Class (Regulation (EU) 2017/1369)	E
Annual energy consumption in kilowatt hour per year (kWh/a) (EU) 2017/1369	233
Freezing Capacity (kg/24h) (4-star Compartment) (EU2017/1369)	22,0
Climate Class (EU) 2017/1369	extended temperate/ tropical
The sum of the volumes of the frozen compartments (EU 2017/1369)	203
Airborne acoustical noise emissions (EU 2017/1369)	38
Airborne acoustical noise emission class (EU 2017/1369)	C