

# KHMP5 86510

12NC: 851349238000

GTIN (EAN) code: 8003437831867

**KitchenAid**

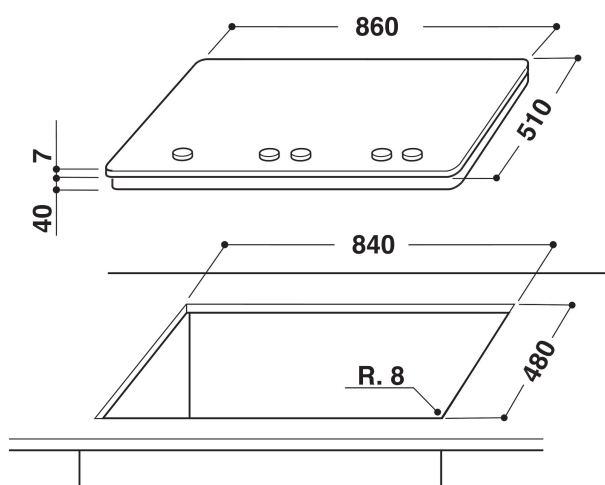

## MAIN FEATURES

Product group	Hob
Construction type	Built-in
Type of control	Mechanical
Type of control settings	-
Number of gas burners	5
Number of electric cooking zones	0
Number of electric plates	0
Number of radiant plates	0
Number of halogen plates	0
Number of induction plates	0
Number of electric warming zones	0
Location of control panel	Front
Basic surface material	Inoxclearcoat
Main colour of product	Inox
Electrical connection rating (W)	0
Gas connection rating (W)	13300
Current (A)	0,2
Voltage (V)	220-240
Frequency (Hz)	50/60
Length of Electrical Supply Cord (cm)	85
Plug type	No
Gas connection	Conic
Width of the product	860
Height of the product	41
Depth of the product	510
Minimum niche height	41
Minimum niche width	840
Niche depth	480
Net weight (kg)	17.8
Automatic programmes	No

## TECHNICAL FEATURES

Power on indicator	No
Number of indicators	0
Type of regulation	Semirapid
Type of lid	Without
Residual heat indicator	Without
Main on/off switch	No
Safety device	-
Timer	No

## PERFORMANCES

Energy input	Gas
--------------	-----