

# Instructions for Installation and Use

60cm DUAL FUEL COOKER

GB

GB

English, 2

HUD 61K S  
HUD 61P S  
HUD 61X S  
HUD 61G S

## Contents

Warning, 2

Introduction, 3

Safety Information, 4

Installation, 5-8

Features, 9

The Controls, 10

Clock/ Minute Minder Operation, 11

Hotplate, 12

Top Oven Cookery Notes, 13

Main Oven Cookery Notes, 14

Grilling, 15

Oven Cooking Charts, 16-17

Care and Cleaning, 18-20

Something Wrong With Your Cooker?, 21

If Something Still Goes Wrong, 22

Disposal of Your Appliance, 22

Hotpoint Service Cover, 23

Guarantee Information, 24

 **Hotpoint**

Please phone us on  
08448 24 24 24  
to activate your  
guarantee

# WARNING

GB

**WARNING:** The appliance and its accessible parts become hot during use.

Care should be taken to avoid touching heating elements. Children less than 8 years of age shall be kept away unless continuously supervised.

This appliance can be used by children aged from 8 years and above and persons with reduced physical, sensory or mental capabilities or lack of experience and knowledge if they have been given supervision or instruction concerning use of the appliance in a safe way and understand the hazards involved. Children shall not play with the appliance. Cleaning and user maintenance shall not be made by children without supervision.

**WARNING:** Unattended cooking on a hob with fat or oil can be dangerous and may result in fire.

**NEVER** try to extinguish a fire with water, but switch off the appliance and then cover flame e.g. with a lid or a fire blanket.

Do not use harsh abrasive cleaners or sharp metal scrapers to clean the oven door glass since they can scratch the surface, which may result in shattering of the glass.

The internal surfaces of the compartment (where present) may become hot.

Never use steam cleaners or pressure cleaners on the appliance. Remove any liquid from the lid before opening it.

Do not close the glass cover (if present) when the gas burners or electric hotplates are still hot.

**WARNING:** Ensure that the appliance is switched off before replacing the lamp to avoid the possibility of electric shock.

**CAUTION:** the use of inappropriate hob guards can cause accidents.

! When you place the rack inside, make sure that the stop is directed upwards and in the back of the cavity.

**To the Installer:**

Before installation, fill in the product details on the back cover of this book.

The information can be found on the rating plate.

**To the User:**

You must read the instructions prior to installing and using the appliance and then retain them for future reference.

! Before operating your new appliance please read this instruction booklet carefully. It contains important information concerning the safe operation, installation and maintenance of the appliance.

! Please keep these operating instructions for future reference. Pass them on to possible new owners of the appliance.

**Retention of this Instruction Book**

This Instruction Book must be kept handy for reference as it contains important details on the safe and proper use of the appliance.

If you sell or pass the appliance to someone else, or move house and leave it behind, make sure this Book is also provided so the new owner can become familiar with the appliance and safety warnings.

Your new appliance is guaranteed\* and will give lasting service. This guarantee is only applicable if the appliance has been installed in accordance with the installation instructions detailed in this booklet.

To help make best use of your cooking equipment, please read this booklet carefully.

The cooker is designed specifically for domestic use and responsibility will not be accepted for use in any other installation.

**When the cooker is first used an odour may be emitted, this will cease after a period of use.**

When first using the cooker ensure that the room is well ventilated (e.g. open a window or use an extractor fan) and that persons who may be sensitive to the odour avoid any fumes.

It is suggested that any pets be removed from the room until the smell has ceased. This odour is due to temporary finish on oven liners and elements and also any moisture absorbed by the insulation.

Your new cooker is guaranteed and will give lasting service.

The guarantee is only applicable if the cooker has been installed in accordance with the Installation Instructions.

The cooker is designed specifically for domestic use and responsibility will not be accepted for use in any other installation.

Your new cooker is guaranteed and will give lasting service.

The guarantee is only applicable if the cooker has been installed in accordance with the Installation Instructions.

The cooker is designed specifically for domestic use and responsibility will not be accepted for use in any other installation.

**\* The guarantee is subject to the provisions that the appliance:**

**(a) Has been used solely in accordance with the Users Instruction Book.**

**(b) Has been properly connected to a suitable supply voltage as stated on the rating plate attached to this equipment.**

**(c) Has not been subjected to misuse or accident or been modified or repaired by any person other than the authorised employee or agent.**

**(d) Has been correctly installed.**

Our policy is one of continual improvement in design and development, therefore strict accuracy of illustrations and descriptions cannot be guaranteed.

---

## Technical Characteristics

---

---

**Top Oven** Usable Volume: 39 Litres

---

**ENERGY LABEL and ECODESIGN**

Regulation (EU) No 65/2014 supplementing Directive 2010/30/EU.

Regulation (EU) No 66/2014 implementing Directive 2009/125/EC.

Standard EN 60350-1  
Standard EN 50564.

Declared energy consumption for  
Natural convection Class

heating mode: Conventional

---

**Main Oven**

Usable Volume: 71 Litres

---

**ENERGY LABEL and ECODESIGN**

Regulation (EU) No 65/2014 supplementing Directive 2010/30/EU.

Regulation (EU) No 66/2014 implementing Directive 2009/125/EC.

Standard EN 60350-1  
Standard EN 50564.

Declared energy consumption for  
Forced convection Class

heating mode: Fan Oven 

---

**Hob****ECODESIGN**

Regulation (EU) No 66/2014 implementing Directive 2009/125/EC.

Standard EN 30-2-1

---

**Voltage and Frequency**

230-240V~ 50/60Hz

---

# Safety Information

GB

Please read the precautions below before using your cooker.

## ALWAYS . . .

- ALWAYS make sure you understand the controls before using the cooker.
- ALWAYS check that all controls on the cooker are turned off after use.
- ALWAYS stand back when opening an oven door to allow heat to disperse.
- ALWAYS use dry, good quality oven gloves when removing items from the ovens.
- ALWAYS take care when removing items from the top oven/grill when the main oven is on, as the contents may be hot.
- ALWAYS keep the oven and grill doors closed when the cooker is not in use.
- ALWAYS place pans centrally over the hotplate burners and position them so that the handles cannot accidentally be caught or knocked or become heated by other burners.

## ALWAYS **keep the cooker clean, as a build up of grease or fat from cooking can cause a fire.**

- ALWAYS allow the cooker to cool before cleaning.
- ALWAYS follow the basic principles of food handling and hygiene to prevent the possibility of bacterial growth.
- ALWAYS keep ventilation slots clear of obstructions.
- ALWAYS turn off the electricity supply before cleaning or replacing an oven lamp.
- ALWAYS refer servicing to gas safe registered appliance service engineers.
- ALWAYS The appliance must be used by adults only for the preparation of food, in accordance with the instructions outlined in this booklet. Any other use of the appliance (e.g. for heating the room) constitutes improper use and is dangerous. The manufacturer may not be held liable for any damage resulting from improper, incorrect and unreasonable use of the appliance.

## SAFETY ADVICE IN CASE OF A CHIP-PAN FIRE

In the event of a chip pan fire or any other pan fire.

1. TURN OFF THE COOKER APPLIANCE AT THE WALL SWITCH.
  2. COVER THE PAN WITH A FIRE BLANKET OR DAMP CLOTH, this will smother the flames and extinguish the fire.
  3. LEAVE THE PAN TO COOL FOR AT LEAST 60 MINUTES BEFORE MOVING IT. Injuries are often caused by picking up a hot pan and rushing outside with it.
- NEVER USE A FIRE EXTINGUISHER TO PUT OUT A PAN FIRE as the force of the extinguisher is likely to tip the pan over.
- Never use water to extinguish oil or fat fires.

## NEVER . . .

- NEVER leave children unsupervised where the cooker is installed as all surfaces will get hot during and after use.
- NEVER allow anyone to sit or stand on any part of the cooker.
- NEVER store items that children may attempt to reach above the cooker.
- NEVER heat up unopened food containers as pressure can build up causing the container to burst.
- NEVER store chemicals, food stuffs, pressurised containers in or on the cooker, or in cabinets immediately above or next to the cooker.
- NEVER fill a deep fat frying pan more than 1/3 full of oil, and never use a lid. DO NOT LEAVE UNATTENDED WHILE COOKING.
- NEVER place flammable or plastic items on or near the hotplate.
- NEVER use proprietary spillage collectors on the hotplate.
- NEVER use the cooker as a room heater.

- NEVER dry clothes or place other items over or near to the hotplate or oven/grill doors.
- NEVER wear garments with long flowing sleeves whilst cooking.
- NEVER let children play with the appliance.
- NEVER should the appliance be operated by people (including children) with reduced physical, sensory or mental capacities, by inexperienced individuals or by anyone who is not familiar with the product. These individuals should, at the very least, be supervised by someone who assumes responsibility for their safety or receive preliminary instructions relating to the operation of the appliance.

**NOTE:** The use of a gas cooking appliance results in the production of heat and moisture in the room in which it is installed. Always ensure that the kitchen is well ventilated; keep natural ventilation holes open or install a mechanical ventilation device (mechanical extractor hood).

In particular when using the grill or more than one hotplate burner, open a window if a mechanical ventilation device is not operating.

!for their safety or receive preliminary instructions relating to the operation of the appliance.

## NOTICE

### ! VERY HOT SURFACES

FOOD OR GREASE ON THESE SURFACES COULD CAUSE SMOKE AND POSSIBLY EVEN BURN YOU MUST KEEP THE OVEN AND GRILL CAVITIES CLEAN

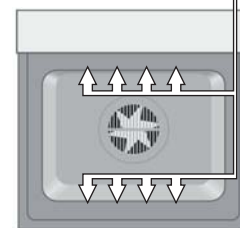

### ! ATTENTION

DURING INSTALLATION THE FEET OF THE APPLIANCE MUST BE LOWERED SO THAT AN AIR GAP OF AT LEAST 10MM (1CM) IS LEFT BETWEEN THE BASE OF THE APPLIANCE AND THE FLOOR.



### ! ATTENTION

WHEN USING THE MAIN OVEN YOU MUST ENSURE THAT THE BASE OF THE CAVITY IS NOT COVERED WITH ALUMINUM FOIL, UTENSIL OR ANY OTHER FORM OF COVERING. FAILURE TO DO THIS MAY RESULT IN THE CAVITY BEING DAMAGED.

## **WARNING - THIS APPLIANCE MUST BE EARTHED.**

### **Mains Connection**

Your cooker should have been checked to ensure that the voltage corresponds with your supply voltage, this is stated on the rating plate, which is situated on the outer rear panel.

The model number and serial number are located on the front of the cooker, as shown on the Feature's page.

The cooker must be connected by a competent person such as one who is a, NICEIC registered contractor to a suitable double-pole control unit with a minimum rating of 32A and a minimum contact clearance of 3mm (applicable to newer properties, older properties where a 30A double pole control unit and a minimum contact clearance of 3mm is acceptable).

The double pole control unit should be fitted adjacent to the cooker, in accordance with IEE regulations. The control unit must be within 2 metres of but not directly above the appliance and should be easily accessible in the event of an emergency. The power supply cable should conform to B.S.6004 with a conductor size of 6mm<sup>2</sup>, minimum.

Access to the mains terminals is gained by removing the rear access cover. The mains cable must pass through the cable clamp adjacent to the terminal block. Sufficient cable should be used to allow the cooker to be pulled out for servicing.

**Ensure that the mains cable is routed away from any brackets affixed to the rear panel and is not trapped to the rear wall when pushing the cooker into position between cabinets.**

### **Levelling**

Four feet are fitted which can be adjusted up or down to set the height (900mm - 930mm) and level the cooker.

The feet can be simply screwed in or out to lower or raise the cooker.

After the correct height is achieved, lock the feet into position by tightening the locking nut using an open ended spanner.

**CAUTION:** Some soft floor coverings may get damaged if the cooker is not moved carefully.

**NOTE:** Ensure oven shelves are level by using a spirit level on the rod shelves.

### **Radio Interference**

This appliance conforms to EN 55014 regarding suppression of radio and television interference.

**Note: Take care in moving the cooker as it is heavy. Take care to ensure that any floor covering is not damaged.**

### **Siting the Cooker**

The cooker is designed to fit between kitchen cabinets spaced 600mm apart. The space either side need only be sufficient to allow withdrawal of the cooker for servicing and cleaning.

It can be used with cabinets one side or both as well as in an angled corner setting. It can also be used freestanding.

Adjacent side walls which project above hob level, must not be nearer to the cooker than 150mm and should be protected by heat resistant material. Any overhanging surface or cooker hood should not be nearer than 650mm.

**Note: This appliance must NOT be fitted on a platform.**

### **Moving the Cooker**

Before moving your cooker, switch off at the cooker control unit, ensure that it is cool.

Open the grill door sufficiently to allow a comfortable grip on the underside front edge of the oven roof, avoiding any grill elements.

**The appliance must not be installed behind a decorative door in order to avoid overheating**

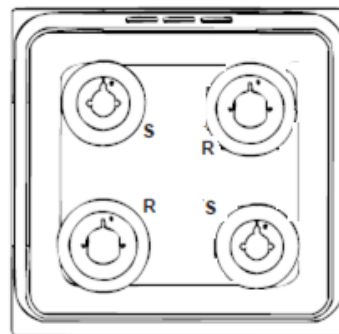

# Installation

GB

Prior to installation, ensure that the local distribution conditions (nature of the gas and gas pressure) and the adjustment conditions are compatible. The adjustment conditions for this appliance are stated on the data badge which is fitted on the back panel. This appliance is not designed to be connected to a combustion products evacuation device. It must be installed and connected in accordance with current installation regulations. Particular attention should be given to the relevant requirements regarding ventilation.

## MODEL NUMBERS HUD61K, HUD61P, HUD61X, HUD61G DSD60S, HAD60S, DSD 60P

### Category II2H3+ (GB)

These models are set to burn NATURAL GAS (G20) at 20 mbar but can be converted for use on BUTANE (G30) at 28-30mbar or PROPANE (G31) at 37mbar with the use of the LPG conversion kit that can be obtained free of charge, if you contact our Genuine Parts and Accessories department (see back page).

## GAS SAFETY (INSTALLATION & USE) REGULATIONS

It is the law that all gas appliances are installed by competent persons in accordance with the current edition of the above regulations. It is in your interest and that of safety to ensure compliance with the law. In the UK, Gas Safe registered installers work to safe standards of practice. The cooker must also be installed in accordance with BS 6172. Failure to install the cooker correctly could invalidate the warranty liability claims and could lead to prosecution.

## LOCATION

The cooker may be located in a kitchen, kitchen/diner or a bed-sitting room, but not in a room containing a bath or shower. The cooker must not be installed in a bed-sitting room of less than 20m<sup>3</sup>. When adjusted for use on Butane (G30) or Propane (G31), the cooker must not be installed in a room or internal space below ground level, e.g. in a basement.

## PROVISION FOR VENTILATION

The room containing the cooker should have an air supply in accordance with BS 5440: Part 2.

The room must have an opening window or equivalent; some rooms may also require a permanent vent. If the room has a volume between 5 and 10m<sup>3</sup>, it will require an air vent of 50cm<sup>2</sup> effective area unless it has a door which opens directly to outside. If the room has a volume of less than 5m<sup>3</sup>, it will require an air vent of 100cm<sup>2</sup> effective area. If there are other fuel burning appliances in the same room, BS 5440: Part 2 should be consulted to determine air vent requirements.

## TECHNICAL DATA

Gas connection	Rp 1/2" (1/2" BSP female)
Pressure test point	Front left hotplate injector
Gas rate adjustment	None
Aeration adjustment	None
Electrical connection	6mm <sup>2</sup> twin and earth 230/240V a.c. 50Hz.

Table 1

Burner	Diameter (mm)	Liquid Gas						Natural Gas				
		Thermal Power kW (p.c.s.*)		By-Pass 1/100 (mm)	Nozzle 1/100 (mm)	Flow* g/h		Thermal Power kW (p.c.s.*)		Nozzle 1/100 (mm)	Flow* l/h	
		Nominal	Reduced			***	**	Nominal	Reduced			
Fast (Large)(R)	100	3.0	0.7	41	86	218	214	3.0	0.7	116	286	
Semi Fast (Medium)(S)	75	2.0	0.4	30	70	145	143	2.0	0.4	103	190	
Supply Pressures	Nominal (mbar) Minimum (mbar) Maximum (mbar)					28-30 20 35	37 25 45					20 17 25

\* At 15°C and 1013 mbar- dry gas

\*\* Propane P.C.S. = 50,37 MJ/Kg

\*\*\* Butane P.C.S. = 49,47 MJ/Kg  
Natural P.C.S. = 37,78 MJ/m<sup>3</sup>

## SPACE FOR FIXING

The cooker can be close fitted below hotplate level. This requires a minimum distance of 600mm between cupboard units of hotplate height. When installing next to a tall cupboard, partition or wall, for a minimum distance of 400mm above hotplate level, allow a side clearance of at least 65mm. The diagram below illustrates the minimum clearance between the cooker and adjacent walls, cupboards etc. The wall behind the cooker, 50mm below and 450mm above, and the width of the cooker, must be a non-combustible material such as ceramic wall tiles. If the cooker is to be fitted close to a corner on the left hand side, ensure that there is a clearance of at least 50mm to allow the main oven door to open fully for when removing oven shelves.

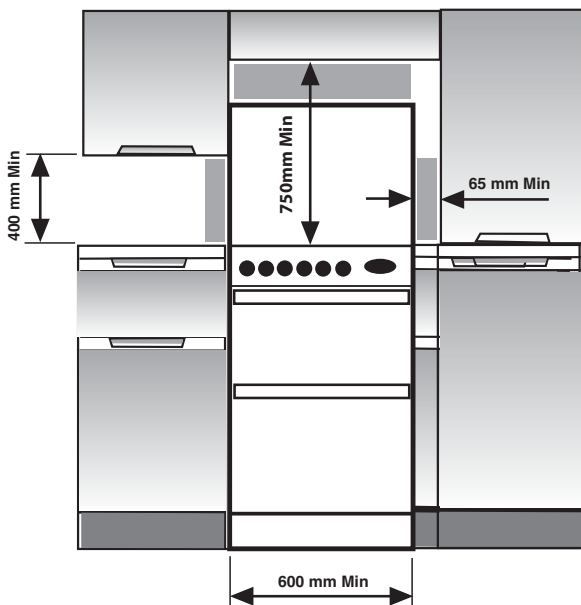

## COOKER HOODS

If a cooker hood is to be installed, refer to the cooker hood manufacturers' instructions regarding fixing height.

## UNPACKING THE COOKER

Unpack the components from inside the grill and oven. Check that the following parts are present:

- |                          |                            |
|--------------------------|----------------------------|
| Grill pan and grid       | Aluminium burner bodies(4) |
| Pan supports             | Literature                 |
| Main oven shelves (2)    | Enamelled burner caps (5)  |
| Top oven/grill shelf (1) |                            |

## LEVELLING

Four skid feet are fitted which can be adjusted up or down to level the cooker.

## CONVERSION FOR USE ON BUTANE (G30) OR PROPANE (G31)

Each burner requires the injector to be replaced and bypass screws adjusted or replaced as follows:

1. Remove the loose hotplate burner parts.
2. Using a 7mm socket, replace the hotplate injectors as appropriate (see table on previous page).
3. Re-position the loose burner parts.
4. Carefully pull off the hotplate control knobs.
5. Using a narrow flat bladed screwdriver rotate the bypass screws fully clockwise. The hotplate tap bypass screws are located down the centre of the spindle.
6. Re-assemble the control panel parts.
7. Secure the self-adhesive LPG conversion label over the gas details on the data badge.

## CONNECTING TO GAS SUPPLY

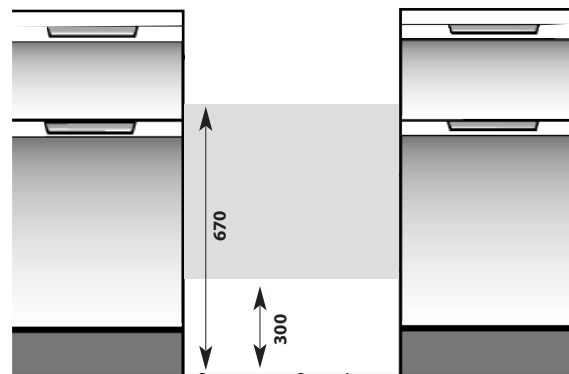

Connection to the cooker should be made with an approved appliance flexible connection to BS 669. A length of 0.9 to 1.25m is recommended. The length of hose chosen should be such that when the cooker is in situ, the hose does not touch the floor. Those cookers converted to use on LPG should be connected with a hose suitable for LPG and capable of withstanding a pressure of 50 mbar. An adaptor backplate should be fitted within the shaded area shown, to allow the cooker to be pushed fully to the wall and to ensure that the flexible hose is only likely to come into contact with areas at the rear of the cooker that do not exceed a temperature rise of 70°C.

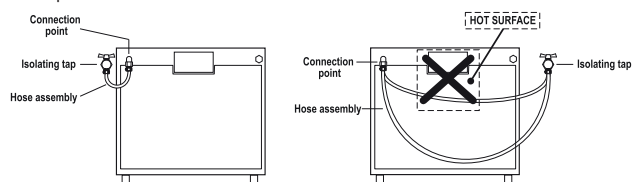

# Electrical Connection

GB

## Warning - THIS APPLIANCE MUST BE EARTHED

The cooker must be connected by a qualified electrician to a suitable double - pole control unit with a minimum rating of 32A and a minimum contact clearance of 3mm, which should be fitted adjacent to (but not above) the cooker, in accordance with IEE regulations.

The power supply cable should conform to BS6004 with a conductor size of 6mm<sup>2</sup>.

The control unit should be easily accessible in the event of an emergency.

This appliance conforms to EN55014 regarding suppression of radio and television interference.

Access to the cooker terminals is by un-clipping the cover. The mains cable must pass through the cable clamp and the screws must be fully tightened. Sufficient cable should be used to allow the cooker to be pulled out for servicing. Ensure that the cover is fully closed and secure afterwards.

Take care not to trap the mains cable when pushing the cooker into its final position.

## Operational Checks

**After installation, check for gas soundness. The supply pressure can be checked at one of the hotplate burner injectors.**

**Check that the hotplate burners ignite correctly and burn with a steady flame.**

**Check for a steady flame at the low setting.**

**Instruct the user on the operation of the cooker.**

**WARNING – THIS APPLIANCE MUST BE EARTHED.**

## Electrical connection

Electric cookers come without a power supply cable. The cooker is designed to operate on an electricity supply which conforms to the electrical data shown on the Rating Plate. The cooker can be connected to the mains only after removing the back panel of the cooker itself with a screwdriver.

**N.B.:** the following installation procedure must be carried out by a qualified electrician. The electrical installation must comply with the IEE Regulations, Building & local By-Lays. For the installation of the feeding cable carry out the following operations:

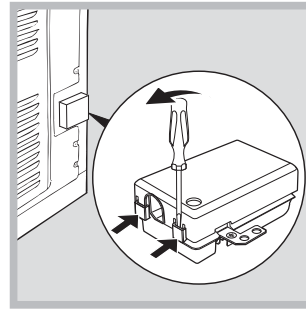

1 Open the terminal board by inserting a screwdriver into the side tabs of the cover. Use the screwdriver as a lever by pushing it down to open the cover (see diagram).

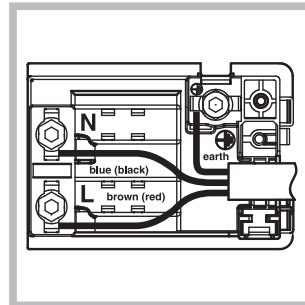

2 Loosen the cable clamp screw and remove it, using a screwdriver as a lever (see figure).

3 Remove the wire contact screws L-N- $\perp$ , then fasten the wires under the screw heads, respecting the colour code: Black/Blue (N),

Red/Brown (L) and Bare Wire/Yellow-Green ( $\perp$ )

1 Once the connections have been made, tighten all the terminal screws fully.

1 Fasten the supply cable in place with the clamp and close the cover of the terminal board.



After installing the power cable, screw the metal cover with three screws.



**This appliance conforms with the following European Economic Community directives:**

- 2006/95/EC of 12/12/06 (Low Voltage) and subsequent modifications;
- 2004/108/EC of 15/12/04 (Electromagnetic Compatibility) and subsequent modifications;
- 93/68/EEC of 22/07/93 and subsequent modifications.
- 2002/96/EC
- 1275/2008 (Stand-by/ Off Mode)



# Features

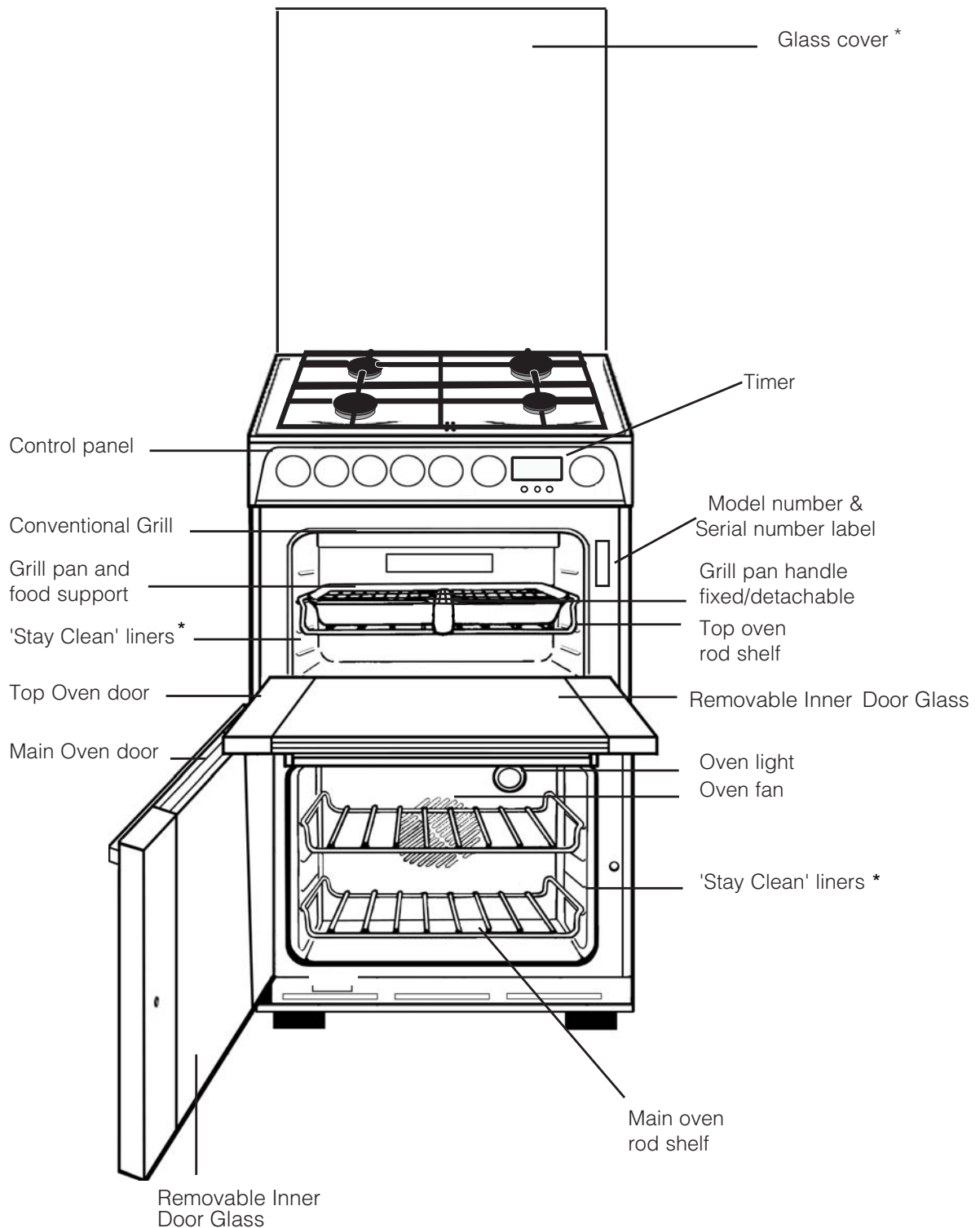

NOTE: To keep the controls cool when the appliance is used, a flow of air may be blown from beneath the control panel. If the appliance is still warm, this cooling fan will run on when all controls have been turned off. This is normal and is not a fault.

The fan will stop once the appliance has cooled.

NOTE: Children should not be allowed to play with the appliance or tamper with the controls.

\*Available only in certain models.

# The controls

GB

Switch on the electricity supply to the cooker at the Cooker Control Unit.

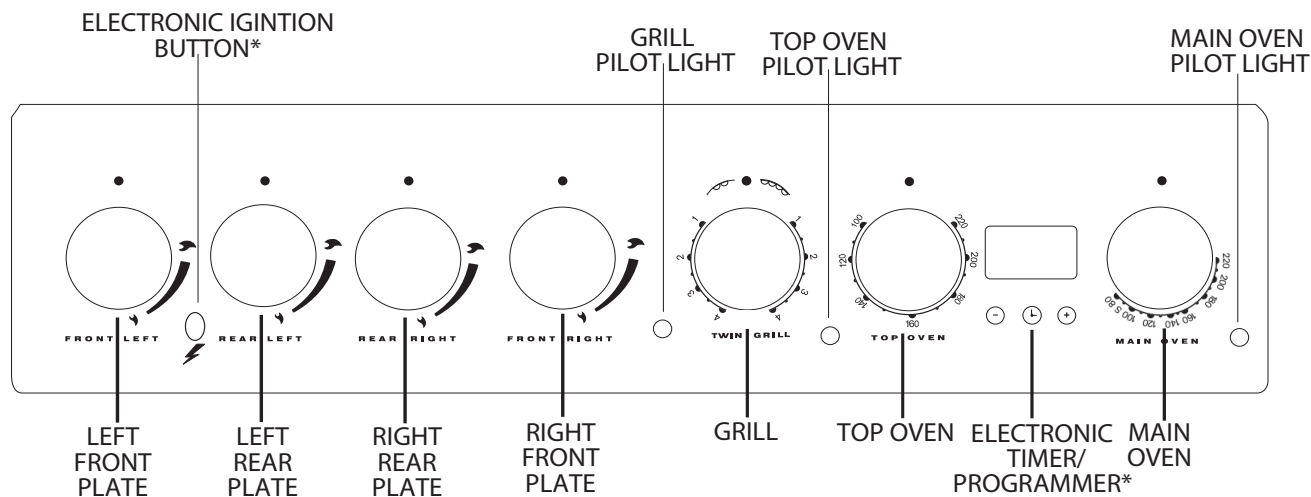

## Control Knobs for the gas burners

The position of the gas burner controlled by each one of the knobs is shown by a solid ring ●. To light one of the burners press down and turn the corresponding knob counter clockwise to the **maximum** 🔥 setting. Each burner can be operated at its maximum, minimum or intermediate power. Shown on the knob are the different symbols for off ● (the knob is on this setting when the symbol corresponds with the reference mark on the control panel), for **maximum** 🔥 and **minimum** 🔥. To obtain these settings, turn the knob counter clockwise with respect to the off position. To turn off the burner, turn the knob clockwise until it stops (corresponding again with the ● symbol).

**! Should the burner flames accidentally go out, turn off the control knob and wait at least 1 minute before trying to relight.**

## Main Oven Light

The main oven light can be switched on, by turning the MAIN OVEN control knob clockwise.

**NOTE: The oven light can be switched off by turning the main oven control knob anticlockwise, to the 'O' off position.**

## Cooling Fan

The cooling fan operates with the ovens and grill. The fan will operate at full speed for a few seconds and then reduce to a lower speed. The cooling fan will only increase to full speed if the temperature inside the cooker reaches above a certain limit.

## Grill Control

The grill control will not operate unless the top oven control is in the 'O' off position.

The grill control provides fully variable heat control for either the twin grill or single (left hand side) grill by selecting any number between 1 & 4. When turned clockwise the twin grill will be switched on and any power setting from 1 - 4 can be selected. The power level numbers are indicated on the control knob.

When turned anti-clockwise the single grill will be switched on and any power setting from 1 - 4 can be selected. The power level numbers are indicated on the control knob.

The off position is identified by an 'O'.

\*Available only in certain models.

# Clock/Minute Minder Operation

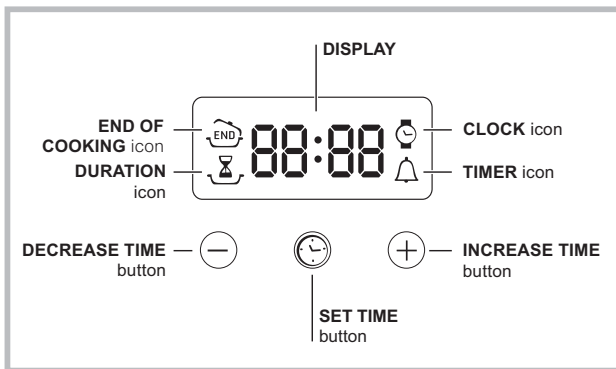



! The Main Oven can be controlled by the automatic timer.

**! NEVER operate the grill when the ovens are set to cook automatically because the oven cavity can become warm and this may cause bacterial growth in food.**

## Setting the clock



! The clock may be set when the oven is switched off or when it is switched on, provided that the end time of a cooking cycle has not been programmed previously. After the appliance has been connected to the mains,

or after a blackout, the  icon and the four numerical digits on the DISPLAY will begin to flash.

1. Press the  button several times until the  icon and the four digits on the display begin to flash.
2. Use the "+" and "-" buttons to adjust the time; if you press and hold either button, the display will scroll through the values more quickly, making it quicker and easier to set the desired value.
3. Wait for 10 seconds or press the  button again to finalise the setting.

## Setting the minute minder

! This function does not interrupt cooking and does not affect the oven; it is simply used to activate the buzzer when the set amount of time has elapsed.



1. Press the  button several times until the  icon and the three digits on the display begin to flash.
2. Use the "+" and "-" buttons to set the desired time; if you press and hold either button, the display will scroll through the values more quickly, making it quicker and easier to set the value.
3. Wait for 10 seconds or press the  button again to finalise the setting.  
The display will then show the time as it counts down. When this period of time has elapsed the buzzer will be activated.

\*Available only in certain models.

## Programming cooking\*





! A cooking mode must be selected before programming can take place.

## Programming the cooking duration

1. Press the  button several times until the  icon and the three digits on the DISPLAY begin to flash.
2. Use the "+" and "-" buttons to set the desired duration; if you press and hold either button, the display will scroll through the values more quickly, making it quicker and easier to set the value.
3. Wait for 10 seconds or press the  button again to finalise the setting.
4. When the set time has elapsed, the text END appears on the DISPLAY, the oven will stop cooking and a buzzer sounds. Press any button to stop the buzzer and turn all control knobs to the 0 position.
  - For example: it is 9:00 a.m. and a time of 1 hour and 15 minutes is programmed. The programme will stop automatically at 10:15 a.m.

## Setting the end time for a cooking mode

! A cooking duration must be set before the cooking end time can be scheduled.

1. Follow steps 1 to 3 to set the duration as detailed above.
2. Next, press the  button until the  icon and the four digits on the DISPLAY begin to flash.
3. Use the "+" and "-" buttons to adjust the cooking end time; if you press and hold either button, the display will scroll through the values more quickly, making it quicker and easier to set the desired value.
4. Wait for 10 seconds or press the  button again to finalise the setting.
5. When the set time has elapsed, the text END appears on the DISPLAY, the oven will stop cooking and a buzzer sounds. Press any button to stop it. Programming has been set when the  and  buttons are illuminated. The DISPLAY shows the cooking end time and the cooking duration alternately.
  - For example: It is 9:00 a.m. and a duration of 1 hour has been programmed. 12:30 is scheduled as the end time. The programme will start automatically at 11:30 a.m.

## Cancelling a programme

To cancel a programme:

- press the  button until the icon corresponding to the setting you wish to cancel and the digits on the display are flashing. Press the "-" button until the digits 00:00 appear on the display.
- Press and hold the "+" and "-" buttons; this will cancel all the settings selected previously, including timer settings.

# Hotplate

GB

The hotplate lid is fitted with a safety device which cuts off the gas supply to the hotplate burners unless the lid is fully open. Do not use the safety device as a means of controlling the hotplate burners.

The hotplate has two high speed burners and two simmering burners which will accommodate pans between 100mm (4") and 240mm (9 1/2") diameter. All pans should be positioned centrally over the burners.

## TO USE THE HOTPLATE

1. Remove any items or spillage from the top of the lid and then raise it to its fully open position.
2. Push in and turn the control knob of the chosen burner anti-clockwise to the large flame symbol. Continue to press the ignition button\* until the sparks light the gas.
3. Turn the control knob anti-clockwise to reduce the heat input. Only turn the control knob between the large flame symbol and the small flame symbol when adjusting the setting.
4. To turn off, turn the control knob fully clockwise to the symbol **O**.

**DO NOT** use the hotplate unless all pan supports are in position.

**DO NOT** use mis-shapen pans which may be unstable.

**DO NOT** use round base woks directly on the pan supports.

**DO NOT** use the glass lid as a working surface.

Each burner is fitted with a spark ignitor for lighting the gas. To ensure rapid lighting of the burners every time they are used, the ignitors must be kept **clean and dry**. Remove any food spillage or cleaning materials from the ignitor using a small nylon brush such as a tooth brush. Access to the ignitor can be achieved by lifting off the loose burner parts carefully when the burners are cool.

When the hotplate burner bodies and caps are removed for cleaning, be careful not to drop any food particles or cleaning materials into the burner bases, to avoid the possibility of blocking the gas jets.

If aluminium based pans are used, a silvery deposit may appear on the top edge of the pan support fingers. See 'Care and Cleaning' section for cleaning information.

## SAFETY REQUIREMENTS FOR DEEP FAT FRYING

1. Never fill chip pans more than one third full with oil or fat.
2. Never leave oil or fat unattended during the heating or cooling period.
3. Never heat fat or fry with a lid on the pan.
4. Always dry food thoroughly before frying, and lower it slowly into the hot oil or fat. Frozen foods in particular will cause frothing and spitting if added too quickly.
5. Always keep the outside of the pan clean and free from streaks of oil or fat.

## HOW TO DEAL WITH A FAT FIRE

1. **Do not** move the pan.
2. Turn off the hotplate burners.
3. Smother the flames with a fire blanket or damp cloth to extinguish the fire. **Do not** use water or a fire extinguisher as the force of it may spread the burning fat or oil over the edge of the pan.
4. Leave the pan for at least 60 minutes before moving it.

## Models with Hob Gas Burner Safety Devices to Prevent Leaks

These models can be identified by the presence of the device itself.

! Since the hob burners are equipped with a safety device,

you must hold the control knob in for about 3-7 seconds after the burner has been lighted to allow the gas to pass until the safety thermocouple has heated.

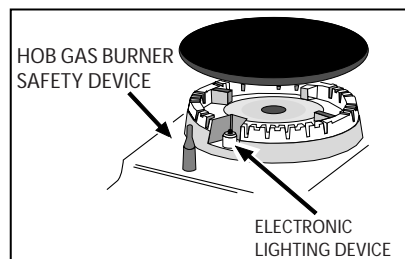

\*Available only in certain models.

# Top Oven Cookery Notes



GB

The top oven should be used to cook small quantities of food. The oven is designed so that the grill element operates at a reduced heat output, this is combined with a heating element situated underneath the floor of the oven.

To ensure even cooking of the food it is important that cooking utensils are positioned correctly on the oven shelf so that the element is directly above.

There are two cooking positions, the shelf placed on runner 1 or 2 (from the base), do not use shelves upside down.

**Food/utensils must not be placed directly on the oven floor.**

There should always be at least 25mm (1in) between the top of the food and the grill element.

**Warning:** Items stored in top oven will get hot when main oven is in use.

## Operation

To heat the oven, turn the control knob clockwise. The top oven pilot light will come on and remain on until the oven reaches the required temperature. The pilot light will automatically go on and off during cooking as the thermostat maintains the correct temperature.

## Cooking meat/poultry

Small joints of meat up to 1.5kg (3 lbs), or poultry, up to 3.6kg (8 lbs) (60cm cookers) in weight can be roasted in a small meat pan in the top oven. Larger joints of meat/poultry weighing more than 3.6kg (8 lbs) (60cm cookers) should be roasted in the main oven.

**Do not use the grill pan as a meat pan in the top oven as air circulation will be seriously restricted.**

## Top oven as a warming compartment for plates

Place the plates/dishes on the shelf, positioned on runner 1, turn top oven control to 100°C for 10-15 minutes. Never use grill control.

# Main Oven Cookery Notes

GB

The oven is fitted with wirework shelf supports and two rod shelves.

To heat the oven turn the knob clockwise, selecting the require temperature between 80°C (176°F) and 220°C (450°F) as recommended in the temperature chart. The pilot light will immediately come on and remain on until the oven reaches the required temperature. This light will then automatically go off and on during cooking as the oven thermostat maintains the correct temperature.

**The main oven fan will switch off at regular intervals during the cooking cycle. This feature helps achieve perfect cooking results whilst giving a benefit to you and the environment of reduced energy consumption.**

It should be noted that at the end of the cooking period there may be a momentary puff of steam when the oven door is opened. This will disperse in a few seconds and is a perfectly normal characteristic of an oven with a good door seal.

Since a circulaire fan oven heats up more quickly, and generally cooks food at a lower temperature than a conventional oven, pre-heating is often unnecessary. However, foods such as bread, scones, Yorkshire pudding, do benefit from being placed in a pre-heated oven.

The 'oven temperature charts' are a guide only, giving approximate cooking temperatures and times. To suit personal taste and requirements, it may be necessary to increase or decrease temperatures by 10°C.

Unless otherwise indicated in the charts food should be placed in a cold oven, i.e. without pre-heating. If food is placed in an already hot oven, the suggested cooking time should be reduced, depending on the type and quantity of food being cooked.

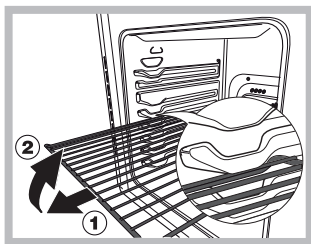

**WARNING!** The oven is provided with a stop system to extract the racks and prevent them from coming out of the oven. (1) As shown in the drawing, to extract them completely, simply lift the racks, holding them on the front part, and pull (2).

## Oven positions

Since the distribution of heat in the circulaire fan oven is very even, most foods will cook satisfactorily on any shelf position, but the shelves should be evenly spaced.

The top oven rod shelf can be used in the main oven when cooking large quantities of food. Additional shelves can be purchased through your oven supplier or our Parts Department (see Key Contacts, back page).

**Food or utensils should Never be placed directly on the floor of the oven for cooking.**

Never use more than 3 shelves in the oven as air circulation will be seriously restricted. To ensure oven circulation do not use meat pans larger than 390 x 300mm (15"x12") and baking trays no larger than 330 x 255mm (13"x 10"), these should be positioned centrally on the oven shelf.

Food should not be placed directly on the floor of the oven. To avoid unnecessary cleaning, rod shelves which are not in use, should be removed from the oven.

## Temperature and time

When all three shelves are used to cook large quantities of food for home freezing or parties, it may be necessary to increase the cooking times given in the temperature charts by a few minutes, to allow for the loss of heat due to extra time taken to load the oven, and the larger mass of food. Baking trays should have an equal gap at either side of the oven.

## Frozen meat and poultry

Joints of meat and whole birds should be defrosted slowly, preferably in a domestic refrigerator (allowing 5-6 hours per 450g (1 lb), or at room temperature (allowing 2-3 hours per 450g (1 lb)).

**CAUTION - ACCESSIBLE PARTS MAY BECOME HOT WHEN THE GRILL IS USED. YOUNG CHILDREN SHOULD BE KEPT AWAY.**

**GRILLING SHOULD NEVER BE UNDERTAKEN WITH THE GRILL DOOR CLOSED**

The grill control is designed to provide variable heat control of either the full width of the grill or just the left half. Turning the control knob clockwise will switch on the full width and turning anti-clockwise will switch on just the left half. A gentle flow of air will be blown from underneath the control panel when the grill is in use.

**TO USE THE GRILL**

1. Open the grill/top oven door and place the shelf in the required position.
2. Turn the grill control knob clockwise to **4** (or **Max**) for full width grilling or anticlockwise for the half grill.
3. Slide the grill pan toward the back of the grill compartment until it stops.
4. Leave the control at **4** (or **Max**) for toast and for sealing and fast cooking of foods. For thicker foods requiring longer cooking, turn the control to a lower setting after sealing on both sides at **4** (or **Max**).

**NOTE:** The grill will not operate unless the top oven control is in the OFF position.

Grilling can be started from cold but for best results preheat for approximately 2 minutes.

The grill elements are covered by a wire mesh to prevent access to live parts. Under no circumstances should pointed objects be inserted through the mesh.

During use, the mesh may become soiled. Do not attempt to clean it while the grill is on. Turn the cooker off at the control unit and wait until it has cooled down before cleaning.

**DO NOT** cover the grill pan or grid with aluminium foil as this can hold fat, intensify the heat and cause a fire hazard.

**Grill Pan Handle**

The grill pan handle is detachable from the pan to facilitate cleaning and storage. Fix the pan handle securely before use:

1. Fit the handle to the grill pan so that the external 'hooks' embrace the edge of the pan (fig. 1)
2. Make sure that the middle part of the handle fits exactly the protruding support of the pan (fig. 2) and holds the pan from the bottom.

The food must be placed on the rack in the grill pan. Position the grill pan on top of the oven rack. The best results are achieved by placing the oven rack on the uppermost shelves. Pouring a little water into the grill pan will make the collection of grease particles more efficient and prevent the formation of smoke.

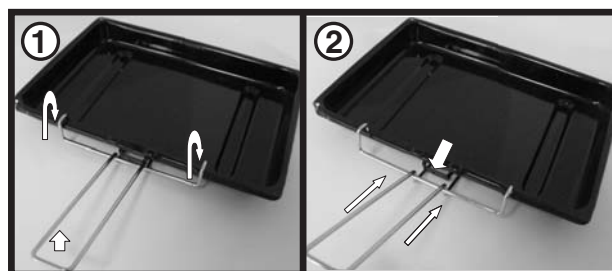

# Oven Cooking Charts

GB

	Top Oven Cooking			
Baking	Pre-heat	Temperature °C	Time in mins.	Position in Oven
Scones	Yes	210/220	10-15	Runner 2 from bottom of oven
Small Cakes	Yes	180/190	20-25	Runner 2 from bottom of oven
Victoria Sandwich	Yes	170/180	20-30	Runner 2 from bottom of oven
Sponge Sandwich	Yes	180/190	20-25	Runner 2 from bottom of oven
Swiss Roll	Yes	200/210	10-15	Runner 2 from bottom of oven
Semi-rich Fruit cakes	Yes	150/160	60-75 7 inch	Runner 2 from bottom of oven
Rich Fruit Cakes	Yes	140/150	Depending on size	Runner 1 or 2 from bottom of oven
Shortcrust Pastry	Yes	190/200	Depending on size	Runner 2 from bottom of oven
Puff Pastry	Yes	200/210	Depending on size	Runner 2 from bottom of oven
Yorkshire Pudding	Yes	190/200	30-40	Runner 2 from bottom of oven
Individual Yorkshire Pudding	Yes	200/210	20-30	Runner 2 from bottom of oven
Milk Pudding	Yes	140/150	90-120	Runner 2 from bottom of oven
Baked Custard	Yes	150/160	40-50	Runner 2 from bottom of oven
Bread	Yes	200/210	30-45	Runner 1 from bottom of oven
Meringues	Yes	100	150-180	Runner 2 from bottom of oven

	Fan Oven Cooking			
Baking	Pre-heat	Temperature °C	Time in mins.	Position in Oven
Scones	Yes	210/220	8-10	Runner 2 from bottom of oven
Small Cakes		170/180	15-20	Runner 2 from bottom of oven
Victoria Sandwich		160/170	20-25	Runner 2 from bottom of oven
Sponge Sandwich	Yes	170/190	15-20	Runner 2 from bottom of oven
Swiss Roll	Yes	180/190	10-15	Runner 2 from bottom of oven
Semi-rich Fruit cakes		140/150	60-75	Runner 2 from bottom of oven
Rich Fruit Cakes		130/140	Depending on size	Runner 1 or 2 from bottom of oven
Shortcrust Pastry		190/200	45-50	Runner 2 from bottom of oven
Puff Pastry		190/200	Depending on use	Runner 2 from bottom of oven
Yorkshire Pudding	Yes	180/190	40-45	Runner 2 from bottom of oven
Individual Yorkshire Pudding	Yes	190/200	20-25	Runner 2 from bottom of oven
Milk Pudding		130/140	105-135	Runner 2 from bottom of oven
Baked Custard		140/150	40-50	Runner 2 from bottom of oven
Bread	Yes	200/210	40-50	Runner 1 from bottom of oven
Meringues		80-90	180-240	Runner 2 from bottom of oven



# Oven Cooking Charts



GB

Top Oven Cooking				
Meat	Pre-heat	Temperature °C	Time (approx.)	Position in Oven
Beef/ Lamb (slow roasting)	Yes	170/180	35 mins per 450g (1lb) + 35 mins over.	Runner 1 from bottom of oven.
Beef/ Lamb (foil covered)	Yes	190/200	35-40 mins per 450g (1lb)	
Pork (slow roasting)	Yes	170/180	40 mins per 450g (1lb) + 40 mins over	
Pork (foil covered)	Yes	190/200	40 mins per 450g (1lb)	
Veal (slow roasting)	Yes	170/180	40-45 mins per 450g (1lb) + 40 mins over	
Veal (foil covered)	Yes	190/200	40-45 mins per 450g (1lb)	
Poultry/Game (slow roasting)	Yes	170/180	25-30 mins per 450g (1lb) + 25 mins over	
Poultry/Game (foil covered)	Yes	190/200	25-30 mins per 450g (1lb)	
Casserole Cooking	Yes	150	2-2½ hrs	

**If using aluminium foil, never:**  
**1.** Allow foil to touch sides of oven. **2.** Cover oven interior with foil. **3.** Cover shelves with foil.

Fan Oven Cooking			
Meat	Pre-heat	Temperature °C	Time (approx.)
Beef	No	160/180	20-25 mins per 450g (1lb) + 20 mins extra
Lamb	No	160/180	20-30 mins per 450g (1lb) + 25 mins extra
Pork	No	160/180	25-30 mins per 450g (1lb) + 25 mins extra
Veal	No	160/170	25-30 mins per 450g (1lb) + 25 mins extra
Chicken/ Turkey up to 4kg (8lb)	No	160/180	18-20 mins per 450g (1lb) + 20 mins extra
Turkey 4 to 5.5kg (8 to 12lb)	No		13-15 mins per 450g (1lb) at 150/160°C
over 5.5kg (12lb)			allow 12 mins per 450g at 150°C
Casserole	No	140-150	1½ - 2 Hrs

**If using aluminium foil, never:** **1.** Allow foil to touch sides of oven. **2.** Cover oven interior with foil. **3.** Cover shelves with foil.

The most accurate method of testing the readiness of joints of meat or whole poultry is to insert a meat thermometer into the thickest part of a joint, or the thickest part of poultry thighs, during the cooking period. The meat thermometer will indicate when the required internal temp has been reached.

**Beef -** Rare: 60°C      **Lamb:** 80°C      **Poultry:** 90°C  
 Medium: 70°C      **Pork:** 90°C  
 Well Done: 75°C      **Veal:** 75°C

GB

**TURN OFF THE MAIN SWITCH AND ENSURE THE COOKER IS COLD BEFORE CLEANING. BEFORE SWITCHING ON AGAIN, ENSURE THAT ALL CONTROLS ARE IN THE OFF POSITION.**

**NEVER USE BIOLOGICAL WASHING POWDER, HARSH ABRASIVES, SCOURING PADS, AEROSOL CLEANERS OR OVEN CHEMICAL CLEANERS OF ANY KIND, UNLESS SPECIFIED BELOW.**



**! Never use steam cleaners or pressure cleaners on the appliance.**

! Clean the glass part of the oven door using a sponge and a non-abrasive cleaning product, then dry thoroughly with a soft cloth. Do not use rough abrasive material or sharp metal scrapers as these could scratch the surface and cause the glass to crack.

! The accessories can be washed like everyday crockery (even in your dishwasher).

#### **Cleaning materials to avoid:**

1. Plastic or nylon pads
2. Household abrasive powders and scourers. These may scratch the surface.
3. Oven chemical cleaners, aerosols and oven pads. Caustic cleaners such as these will etch the surface and attack the metal frame.
4. Bath and sink cleaners may mark the surface.

**ALWAYS SWITCH OFF AT THE MAINS SWITCH BEFORE CLEANING.**

#### **Ceramic hotplates:**

Clean your Ceramic hob top regularly and avoid repeated burning of encrusted contamination.

Your choice of cleaner will depend on the degree of soiling involved (see below).

- **minor soiling**, where the contamination has not burnt hard, can be wiped off with a clean wet cloth
- **major soiling** and strongly-adhering burnt encrustation can be quickly and easily removed with a razor-blade scraper
- hard water stains, grease spots and discoloration having a metallic sheen can be removed with 'Easy Do Cleaner Powder'

\* Available only in certain models

- always condition hob after cleaning by using 'Easy Do Conditioner' or 'Hob Brite'. Apply a small amount of conditioner with a clean damp cloth or paper towel. Rub vigorously. Remove excess with a clean damp cloth or paper towel. Polish with a clean cloth or paper towel before the conditioner dries.

Detergent residues must always be completely removed with a clean wet cloth, (even if the instructions for use suggest otherwise), as they can have an etching effect when reheated. Then wipe dry.

To maintain hob in good condition, we would recommend regular use of the 'Easy Do Powder Cleanser'.

Sprinkle Powder Cleanser on a clean damp cloth or paper towel and rub vigorously for 3 to 4 minutes. Remove all residue with a clean damp cloth or paper towel. Then use conditioner to protect the hob.

For more stubborn marks, mix a small amount of the powder cleanser with 'Jif Lemon Juice' (from a bottle) and carefully spread over the affected area. Cover with a damp paper towel and leave for a minimum of 15 minutes. Rub vigorously. Remove excess with a clean damp cloth or paper towel before the conditioner dries. Polish with a clean cloth or paper towel.

Easy Do products are available from many electrical retailers and our Parts Department. Homecare 'Hob Brite' is available from leading Supermarkets.

#### **'STAY CLEAN' Oven liners\***

Refer to the instructions below for cleaning the 'Stay clean' panels.

#### **How "STAY CLEAN" works:**

The surfaces of the 'Stay clean' oven liners are treated on the mottled face with a special vitreous enamel which absorbs cooking soils. At temperatures of 220°C (425°F) or above, the special surface enables these soils to be slowly destroyed. The higher the temperature the more effective it is. In most cases normal cooking operations at this temperature will permit this cleaning operation to proceed during cooking. However if higher cooking temperatures are not used regularly it may be necessary in order to prevent heavy soiling, to run the oven without a meat pan at maximum setting for a couple of hours.

# Care and Cleaning

GB

**Main Oven Liners** - side and rear panels.  
**Top Oven Liners** - sides

It should not normally be necessary to clean the 'Stay clean' panels in water. If the user feels it is desirable to do so, wash them in warm soapy water, followed by rinsing in clean water. **Do not use enzyme/biological washing powder, harsh abrasives or oven chemical cleaners of any kind.**

## Decorative trims (all models):

It is advisable to clean the decorative trims regularly to prevent any build up of soiling which may detract from the appearance of the cooker.

The recommended method of cleaning is to wipe over the trims with a soft cloth wrung out in hot water or mild non-abrasive cleaner. (If in doubt try the cleaner on a small area of trim which is not noticeable in normal use).

Then, after wiping with a cloth wrung out in clear water, dry with a soft clean cloth.

Never use scouring pads or abrasive cleaners/powders which may scratch the surface.

Take care during cleaning not to damage or distort the door seals. Do not lift the door seal from the oven chassis, if necessary remove the seal by carefully unhooking the corner clips.

Take care that the rating label edges are not lifted during cleaning, and furthermore that the lettering is not blurred or removed.

Control Panel:

Wipe with a damp cloth and polish with a dry cloth.

Stainless trims:

Regularly wipe with a clean, damp cloth and polish with a clean dry cloth.

## Grill:

Remove the wire grid food support, it is best to wash these items immediately after use to prevent stains from being burnt on when used again. Wipe out the Grill compartment, use a fine steel wool soap pad to remove stubborn stains from the floor of the compartment.

## Main oven:

1. Glass Door - open the oven door fully. The glass panel may now be cleaned. Stubborn stains can be removed by using a fine steel wool soap pad. Do not use scouring pads, or abrasive powder, which will scratch the glass. Ensure that the glass panel is not subjected to any sharp mechanical blows. For

slight soiling the inner glass panel may be cleaned, while still warm. For removing stubborn stains see next page.

2. Remove the rod shelves. Use a fine steel wool soap pad to remove stubborn stains from the rod shelves and the floor of the oven. Refer to the instructions on previous page for cleaning the 'Stay clean' panels.

## Doors

Wipe over the outer door glass panels with a cloth wrung out in warm soapy water, then after wiping with a cloth wrung out in clear water, dry with a soft clean cloth. **Ensure that glass doors are not subjected to any sharp mechanical blows.**

## Glass Inner Door Panel

Open the door fully and **unscrew the two screws securing the glass panel**, taking care not to allow the glass to fall. The glass panel may now be washed at the sink. Stubborn stains can be removed by using a fine steel wool soap pad. **Ensure the glass panel is not subjected to any sharp mechanical blows.** Take particular care not to damage the inner surface which is coated with a heat reflective layer. After cleaning, rinse and dry with a soft cloth. For slight soiling the inner glass panel may be cleaned, while still warm, without removing it from the door.

Warning: Oven must not be operated with inner door glass removed.

**Do not use** aerosol cleaners on this oven as they could adversely affect the fan motor unit, and cannot be wiped off the fan blade.

## Replacement oven lamp:

**WARNING: Ensure that the appliance is switched off before replacing the lamp to avoid the possibility of electric shock.**

Open the oven door and remove the rod shelves. Using a suitable cloth to protect the fingers grip the light glass dome, unscrew anti-clockwise and lift. Reach into the aperture and unscrew the lamp anti-clockwise. Fit replacement lamp (25W 300°C rated SES), refit dome.

Do not use the oven lamp as/for ambient lighting

GB

## Cleaning the glass doors

### DROP DOWN DOORS



Open the door fully and carefully slide the first inner glass towards you, taking care not to allow the glass to fall. If necessary, the glass can be pushed delicately from the back side.



Repeat the same procedure with the next glass. Now the external glass panel can be washed.

**WARNING!** As soon as the inner and middle glass panels are removed, the door slams shut.

### SIDE OPENING DOORS

**Cleaning the door glass is the same as the drop down doors.**



**Open the lower door and lift out the inner door glass**



**Remove the two rubber anti-rattle bungs**



**Remove the centre glass taking care to support the weight of the glass when removing and fitting**

The glass panels may now be washed at the sink. Stubborn stains can be removed by using a fine steel wool soap pad. Replace in the reverse order.

Ensure anti-rattle bungs are fitted before fitting inner door glass.

**BE CAREFUL NOT TO DAMAGE THE GLASS PANELS BY PUSHING THEM TOO HARD.**

When fitting the glass make sure it is fitted correctly ie reflective face is fitted the right way round.

Ensure the glass panel is not subjected to any sharp mechanical blows. Take particular care not to damage the inner surface which is coated with a heat reflective layer. After cleaning, rinse and dry with a soft cloth. For slight soiling the inner glass panel may be cleaned, while still warm, without removing it from the door

**Warning:** Oven must not be operated with inner door glass removed.

### Anti- rattle bung

The door glass is equipped with anti-rattle bungs which prevents rattling of the glass when opening and shutting the oven main door. These can be removed for washing.



**WARNING :** Be careful not to lose the bungs when cleaning

### Door and Control Panel (Glass)

Regularly wipe with a clean, damp cloth and polish with a clean, dry cloth.

### Door and Control Panel Trims (Stainless Steel)

Regularly wipe with a clean, damp cloth and polish with a clean, dry cloth.

### Replacement of the Oven Light

**WARNING: Ensure that the appliance is switched off before replacing the lamp to avoid the possibility of electric shock.**

Unscrew the glass cover, using a suitable cloth to protect the fingers and remove carefully. Unscrew the existing light bulb, and remove. Screw the new bulb into position and replace the glass cover, with metal washer, until positioned securely.

# Something Wrong with your Cooker?



Before contacting your Service Centre or Installer, check the problem guide below, there may be nothing wrong with your cooker.

GB

PROBLEM	CHECK
Burner will not light:	<p><u>If all burners fail to ignite:</u> Check that sparks appear at the burners; a clicking noise should be heard. If not;</p> <p>Check that the electricity supply is turned on. If the electricity supply has failed, all burners can be lit by a match.</p> <p><u>If only one burner fails to ignite:</u> Check that the burner is dry and that spillage of food or cleaning fluid remains are not affecting the ignitor or burner ports. Clean away any debris with a dry nylon brush such as an old toothbrush. If a wire wool pad has been used for cleaning around the burner ensure the ignitor is free from any stray strands. Any water on the burner should be dried with a cloth or kitchen towel.</p> <p>On the hotplate make sure that all the burner parts are correctly seated.</p>
Slight odour or small amount of smoke when grill / oven used first time.	This is normal and should cease after a short period.
Oven cooks too fast or too slow.	Check that the gas mark and shelf positions are as recommended in the Oven Cooking Charts. However, it may be necessary to increase or decrease the recommended setting slightly to suit your taste.
Cannot set an "Auto Cook" programme or cannot get the timer to turn the oven on or off at the required times.	Read the Timer instructions in this book carefully remembering that the Cook period is the length of time that the timer will switch the oven(s) on as part of an Auto Cooking Programme.
Timer Display shows "0:00" with "Auto" Flashing.	The electricity supply to the cooker may have been interrupted, but has now come back on again. Set the correct time of day by following the instructions given in the timer section of this book.
Main oven does not work, but the grill, top oven and hotplate burners work.	The timer may be set for an Auto Cooking Programme. Check the timer to see if "AUTO" is illuminated. If it is, follow the instructions given in the timer section of this book to cancel the Auto Cooking Programme.
Oven lamp does not work.	The oven lamp is not covered by the guarantee. The part is easily changed (see the section on oven lamp replacement). A new lamp may be obtained from our Parts department, (see back page).
Main Oven Fan keeps turning on and off	This is normal operation. The main oven fan switches on and off at regular intervals during the cooking cycle.

# If something still goes wrong ...

GB

## .... don't panic

Just quickly check these points before calling a Hotpoint engineer:

1. Check that the mains supply is switched on.
2. Check that the Timer is not flashing or, the incorrect 'Time of Day' is showing:
  - The power supply has been interrupted but has now come back on again. Reset the Timer to the correct 'Time of Day' as stated in the Timer instructions. Oven back to Manual operation.
3. If using the Grill in the Top Oven make sure that the Top Oven control is set to 'O' Off.

## If it still won't work...

### Ring Service (see back cover)



## Disposal of your product

To minimise the risk of injury to children please dispose of your product carefully and safely. Remove all doors and lids. Remove the mains cable (where fitted) by cutting off flush with the appliance and always ensure that no plug is left in a condition where it could be connected to the electricity supply.

To help the environment, Local Authority instructions should be followed for the disposal of your product.



## Disposal of old electrical appliances

The European Directive 2002/96/EC on Waste Electrical and Electronic Equipment (WEEE), requires that old household electrical appliances must not be disposed of in the normal unsorted municipal waste stream. Old appliances must be collected separately in order to optimise the recovery and recycling of the materials they contain and reduce the impact on human health and the environment.

The crossed out "wheeled bin" symbol on the product reminds you of your obligation, that when you dispose of the appliance it must be separately collected.

Consumers should contact their local authority or retailer for information concerning the correct disposal of their old appliance.

## Parts

Please remember your new appliance is a complex piece of equipment.

'DIY' repairs or unqualified and untrained service people may put you in danger, could damage the appliance and might mean you lose cover under Hotpoint's Parts Guarantee.

If you do experience a problem with the appliance don't take risks; call in Hotpoint's own Service Engineer (see back page).

Our spare parts are designed exclusively to fit only Hotpoint appliances. Do not use them for any other purpose as you may create a safety hazard.

## Respecting and conserving the environment

- Whenever possible, avoid pre-heating the oven and always try to fill it. Open the oven door as little as possible because heat is lost every time it is opened. To save a substantial amount of energy, simply switch off the oven 5 to 10 minutes before the end of your planned cooking time and use the heat the oven continues to generate.
- Keep gaskets clean and tidy to prevent any door energy losses
- If you have a timed tariff electricity contract, the "delay cooking" option will make it easier to save money by moving operation to cheaper time periods.
- The base of your pot or pan should cover the hot plate. If it is smaller, precious energy will be wasted and pots that boil over leave encrusted remains that can be difficult to remove.
- Cook your food in closed pots or pans with well-fitting lids and use as little water as possible. Cooking with the lid off will greatly increase energy consumption
- Use purely flat pots and pans
- If you are cooking something that takes a long time, it's worth using a pressure cooker, which is twice as fast and saves a third of the energy.

## Satisfaction Guaranteed or Your Money Back

Hotpoint gives you a unique 'Satisfaction Guaranteed' promise - valid for ninety days after you have purchased your Hotpoint product. If there is a technical problem with your Hotpoint appliance, just call Hotpoint Service (see back page). If necessary we will arrange for an engineer to call. If the technical problem is not resolved under this Guarantee, Hotpoint will replace your appliance or, if you prefer, give you your money back. Your statutory rights are not affected, and the Guarantee is additional and subject to the terms of Hotpoint's Five Year Parts Guarantee.

## Hotpoint's Free Five Year Guarantee

From the moment your appliance is delivered Hotpoint guarantees it for **FIVE YEARS**.

- In the Five Years all replacement parts are **FREE** provided that they are fitted by our own Service Engineer. During the first year our Engineer's time and labour is also free.
- Our guarantee covers loss of food in our refrigeration and freezer products up to £250 during the first year, subject to verification by one of our engineers.
- After the first year we will charge for our Engineer's time and labour. We do, however, operate a range of Service Plans (see opposite) which, for an annual payment, enables you to cover any repair costs which may be necessary.
- All our service repairs are guaranteed for twelve months in respect of our labour and any parts fitted.
- The appliance must be used in the United Kingdom, and must not be tampered with or taken apart by anyone other than our own Service Engineers.
- You may, however, buy parts which can be safely fitted without specialist knowledge or equipment. The correct fitting of such parts, provided they are genuine Hotpoint spares, will not affect your Guarantee. Parts are available from our Hotpoint Spares Centres (see back page).
- Our guarantee does not cover the cost of any repair, or loss of food in refrigeration products, due to power failure, accidents or misuse. Nor does it cover the cost of any visits to advise you on the use of your appliance. Please read thoroughly the instruction book supplied with this appliance.
- If at any time during the Guarantee period we are unable to repair your appliance, we will refund any repair costs paid to us in the previous twelve months. We will also offer you a new appliance at a reduced charge instead of a repair.
- Our Guarantee is in addition to and does not affect your legal rights.
- Should you need independent advice on your consumer rights, help is available from your Consumer Advice Centre, Law Centre, Trading Standards Department and Citizens Advice Bureau.
- All Hotpoint servicing is carried out by our own Service Organisation located throughout the United Kingdom and Eire. We will be happy to deal with any problems which you may have.

## Hotpoint's Extended Warranties

Whether you have just one or a number of Hotpoint appliances in your kitchen, Hotpoint has a range of Service Plans to give you complete peace of mind. They enable you to extend your one year labour guarantee so that you can have repairs completed **FREE** during the membership period.

## Service Cover

We offer a number of payment methods; cheque, credit card or you can spread the cost and pay by direct debit (full details can be obtained on Free phone 0800 716356). This covers you for all repairs during the period of cover, which can be from 1 to 4 years. Service Cover also includes loss of food, up to the value of £250, in refrigeration appliances. There is also an option of Service Cover with Maintenance at an additional cost. This includes an annual Electrical and Safety check and replacement of any parts as necessary.

## Kitchen Cover

An annual payment covers you for all repairs for all your Hotpoint appliances which are less than ten years old. It also covers the cost of loss of food up to £250 in our refrigeration and freezer products. There is also the option of Kitchen Cover with Maintenance at an additional cost. Any additional Hotpoint appliances purchased after you have joined Hotpoint Kitchen Cover will automatically be included during the annual period of cover without further charge.

## Appliance Registration

To ensure that you have the opportunity to benefit from any of the above Service Schemes and other offers you should complete and return immediately the Appliance Registration Form/Questionnaire supplied with this appliance. Full details and costs of our Service Schemes, together with an application form, will be sent to you at the end of the first year of the guarantee.

## Annual Safety/Maintenance Checks

Hotpoint strongly recommends that all its appliances are regularly checked for electrical and mechanical safety, whether or not they are covered by a Service Plan. Worn door gaskets or hoses may cause a leak on an appliance, which could become dangerous if neglected.

## Proof of Purchase

For future reference please attach your purchase receipt to this booklet and keep it in a safe place.

## Spares and Accessories

Spares and accessories can be ordered from your local Hotpoint Spares Centre (see back page), using the order form enclosed.

**NOTE:** Our Engineers will use every effort to avoid damage to floor coverings and adjacent units when carrying out repairs/service work, but in locations where the Engineer advises you that it will be impossible to move appliances without risk of damage, he will only proceed with your approval that no liability is accepted.



## Product Guarantee and Repair Information

### Guarantee

#### 12 Months Parts and Labour Guarantee

Your appliance has benefit of our manufacturer's guarantee, which covers the cost of breakdown repairs for twelve months from the date of purchase. This gives you the reassurance that if, within that time, your appliance is proven to be defective because of either workmanship or materials, we will, at our discretion, either repair or replace the appliance at no cost to you: This guarantee is subject to the following conditions:

- The appliance has been installed and operated correctly and in accordance with our operating and maintenance instructions.
- The appliance is used only on the electricity or gas supply printed on the rating plate.
- The appliance has been used for normal domestic purposes only.
- The appliance has not been altered, serviced, maintained, dismantled, or otherwise interfered with by any person not authorised by us.
- Any repair work must be undertaken by us or our appointed agent.
- Any parts removed during repair work or any appliance that is replaced become our property.
- The appliance is used in the United Kingdom or Republic of Ireland.

#### The guarantee does not cover:

- Damage resulting from transportation, improper use, neglect or interference or as a result of improper installation.
- Replacement of any consumable item or accessory. These include but are not limited to: plugs, cables, batteries, light bulbs, fluorescent tubes and starters, covers and filters.
- Replacement of any removable parts made of glass or plastic.

**THIS GUARANTEE WILL NOT APPLY IF THE APPLIANCE HAS BEEN USED IN COMMERCIAL OR NON-DOMESTIC PREMISES.**

### Recycling and Disposal Information

As part of Hotpoint's continued commitment to helping the environment, Hotpoint reserves the right to use quality, recycled components to keep down customer costs and minimise material wastage.

Please dispose of packaging and old appliances carefully. To minimise the risk of injury to children, remove the door, plug, and cut the mains cable off flush with the appliance. Dispose of these parts separately to ensure that the appliance can no longer be plugged into mains socket, and the door cannot be locked shut.

### Repairs and After Sales

For product help and advice, repairs, spare parts or accessories, we're here to help.

For local repair engineers - **03448 111 606**  
ROI - **0818 313 413**

UK standard local rate applies  
ROI local Irish rate applies

For Parts and Accessories visit:  
**parts.hotpoint.co.uk/shop**

Please remember to register your appliance at **www.hotpointservice.co.uk** to activate your 10 year parts guarantee.

**Please note, our advisors will require the following information:**

Model number:

Serial number: