

# W11I OM1 4MS2 H

12NC: 859991549450

GTIN (EAN) code: 8003437834790

**Whirlpool**

SENSING THE DIFFERENCE

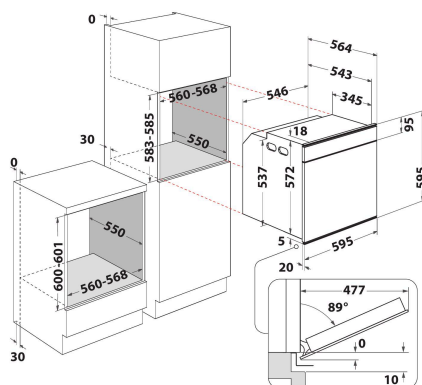

## MAIN FEATURES

Product group	Oven
Commercial code	W11I OM1 4MS2 H
Main colour of product	Dark grey
Construction type	Built-in
Type of control	Electronic
Type of control settings	-
Are any hobs controls integrated?	No
Which kind of hobs can be controlled?	-
Automatic programmes	Yes
Current (A)	16
Voltage (V)	220-240
Frequency (Hz)	50/60
Length of Electrical Supply Cord (cm)	90
Plug type	No
Depth with open door 90 degree (mm)	-
Height of the product	595
Width of the product	595
Depth of the product	564
Minimum niche height	0
Minimum niche width	0
Niche depth	0
Net weight (kg)	40.5
Usable volume (of cavity)	73
Integrated Cleaning system	Hydrolytic
Grids of the cavity	2
Trays	2

## TECHNICAL FEATURES

Timer	-
Time control	Electronic
Time-setting options	Start and Stop
Safety device	-
Interior light	Yes
Number of interior lights of the cavity	2
Position of interior lights of the cavity	Right side
Oven guides of the cavity	Grids
Probe of the cavity	Yes

## ENERGY LABEL

Energy input	Electric
Type of energy of the cavity	електрически
Energy efficiency class - NEW (2010/30/EU)	A+
Energy consumption per cycle conventional - NEW (2010/30/EU)	0.91
Energy consumption per cycle forced air convection - NEW (2010/30/EU)	0.7