

SAFETY INSTRUCTIONS

Download the complete instruction manual on <http://aristonchannel.com> or call the phone number shown on the warranty booklet.

Before using the appliance, read these safety instructions. Keep them nearby for future reference. These instructions and the appliance itself provide important safety warnings, to be observed at all times. The manufacturer declines any liability for failure to observe these safety instructions, for inappropriate use of the appliance or incorrect setting of controls.

⚠ Very young children (0-3 years) should be kept away from the appliance. Young children (3-8 years) should be kept away from the appliance unless continuously supervised. Children from 8 years old and above and persons with reduced physical, sensory or mental capabilities or lack of experience and knowledge can use this appliance only if they are supervised or have been given instructions on safe use and understand the hazards involved. Children must not play with the appliance. Cleaning and user maintenance must not be carried out by children without supervision.

⚠ **WARNING:** The appliance and its accessible parts become hot during use. Care should be taken to avoid touching heating elements.

Children less than 8 years of age shall be kept away unless continuously supervised.

⚠ **WARNING:** If the hob surface is cracked, do not use the appliance - risk of electric shock.

⚠ **WARNING:** Danger of fire: Do not store items on the cooking surfaces.

⚠ **CAUTION:** The cooking process has to be supervised. A short cooking process has to be supervised continuously.

⚠ **WARNING:** Unattended cooking on a hob with fat or oil can be dangerous - risk of fire. NEVER try to extinguish a fire with water: instead, switch off the appliance and then cover flame e.g. with a lid or a fire blanket.

⚠ Do not use the hob as a work surface or support. Keep clothes or other flammable materials away from the appliance, until all the components have cooled down completely - risk of fire.

PERMITTED USE

⚠ **CAUTION:** the appliance is not intended to be operated by means of an external switching device, such as a timer, or separate remote controlled system.

⚠ This appliance is intended to be used in household and similar applications such as: staff kitchen areas in shops, offices and other working environments; farm houses; by clients in hotels, motels, bed & breakfast and other residential environments.

⚠ No other use is permitted (e.g. heating rooms).

IMPORTANT TO BE READ AND OBSERVED

⚠ This appliance is not for professional use. Do not use the appliance outdoors.

INSTALLATION

⚠ The appliance must be handled and installed by two or more persons - risk of injury. Use protective gloves to unpack and install - risk of cuts.

⚠ Installation, including water supply (if any), electrical connections and repairs must be carried out by a qualified technician. Do not repair or replace any part of the appliance unless specifically stated in the user manual. Keep children away from the installation site. After unpacking the appliance, make sure that it has not been damaged during transport. In the event of problems, contact the dealer or your nearest After-sales Service. Once installed, packaging waste (plastic, styrofoam parts etc.) must be stored out of reach of children - risk of suffocation. The appliance must be disconnected from the power supply before any installation operation - risk of electric shock. During installation, make sure the appliance does not damage the power cable - risk of fire or electric shock. Only activate the appliance when the installation has been completed.

⚠ Carry out all cabinet cutting operations before fitting the appliance and remove all wood chips and sawdust.

⚠ If the appliance is not installed above an oven, a separator panel (not included) must be installed in the compartment under the appliance.

ELECTRICAL WARNINGS

⚠ It must be possible to disconnect the appliance from the power supply by unplugging it if plug is accessible, or by a multi-pole switch installed upstream of the socket in accordance with the wiring rules and the appliance must be earthed in conformity with national electrical safety standards.

⚠ Do not use extension leads, multiple sockets or adapters. The electrical components must not be accessible to the user after installation. Do not use the appliance when you are wet or barefoot. Do not operate this appliance if it has a damaged power cable or plug, if it is not working properly, or if it has been damaged or dropped.

⚠ If the supply cord is damaged, it must be replaced with an identical one by the manufacturer, its service agent or similarly qualified persons in order to avoid a hazard - risk of electric shock.

CLEANING AND MAINTENANCE

⚠ **WARNING:** Ensure that the appliance is switched off and disconnected from the power supply before performing any maintenance operation; never use steam cleaning equipment - risk of electric shock.

⚠ Do not use abrasive or corrosive products, chlorine-based cleaners or pan scourers.

DISPOSAL OF PACKAGING MATERIALS

The packaging material is 100% recyclable and is marked with the recycle symbol .

The various parts of the packaging must therefore be disposed of responsibly and in full compliance with local authority regulations governing waste disposal.

DISPOSAL OF HOUSEHOLD APPLIANCES

This appliance is manufactured with recyclable or reusable materials. Dispose of it in accordance with local waste disposal regulations. For further information on the treatment, recovery and recycling of household electrical appliances, contact your local authority, the collection service for household waste or the store where you purchased the appliance. This appliance is marked in compliance with European Directive 2012/19/EU, Waste Electrical and Electronic Equipment (WEEE). By ensuring this product is disposed of correctly, you will help prevent negative consequences for the environment and human health.

The symbol  on the product or on the accompanying documentation indicates that it should not be treated as domestic waste but must be taken to an appropriate collection center for the recycling of electrical and electronic equipment.

ENERGY SAVING TIPS

Make the most of your hot plate's residual heat by switching it off a few minutes before you finish cooking.

The base of your pot or pan should cover the hot plate completely; a container that is smaller than the hot plate will cause energy to be wasted. Cover your pots and pans with tight-fitting lids while cooking and use as little water as possible. Cooking with the lid off will greatly increase energy consumption.

Use only flat-bottomed pots and pans.

DECLARATION OF CONFORMITY

This appliance meets the Ecodesign requirements of European Regulation n. 66/2014, in compliance with the European standard EN 60350-2.

INSTALLATION

- The cooktop must be set into a worktop between 20 mm and 50 mm deep.
- There must be nothing between the cooktop and the oven (cross rails, brackets, etc.).
- The distance between the lower face of the glass ceramic hob and the cupboard or separating panel must be at least 20 mm.
- If the cooktop is to be installed next to a column unit, leave a distance of at least 100 mm from the edge of the cooktop to the side of the column unit.
- For built-in dimensions and installation see the picture in this paragraph.
- A minimum distance must be maintained between the hob and the hood above it. Please refer to the user manual of the hood for more informations.
- Apply the supplied gasket to the cooktop (unless it has already been fitted), after having cleaned its surface.
- **Do not install the cooktop near a dishwasher or washing machine, so that the electronic circuits do not come into contact with steam or moisture, which could damage them.**
- If an oven is installed beneath the cooktop, make sure that it is equipped with a cooling system. If the temperature of the electronic circuits exceeds the maximum permitted temperature, the cooktop will switch off automatically; in this case, wait for a few minutes until the internal temperature of the electronic circuits reaches a tolerable level, at which point it will be possible to switch the hob on again.



PLACING THE HOB

After the electrical connection (see the chapter "Electrical connection"), position each fixing clips on the dedicated slots on the lateral sides of the hob as shown in the picture. Then push the hob inside the cut out and check that the glass is flat and parallel to the worktop. The fixing clips are designed for every type of worktop material (wood, marble, etc.).

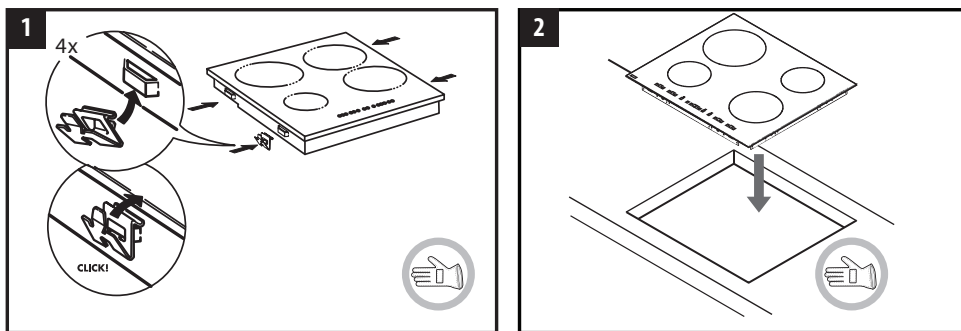

DIMENSIONS AND DISTANCES TO BE MAINTAINED

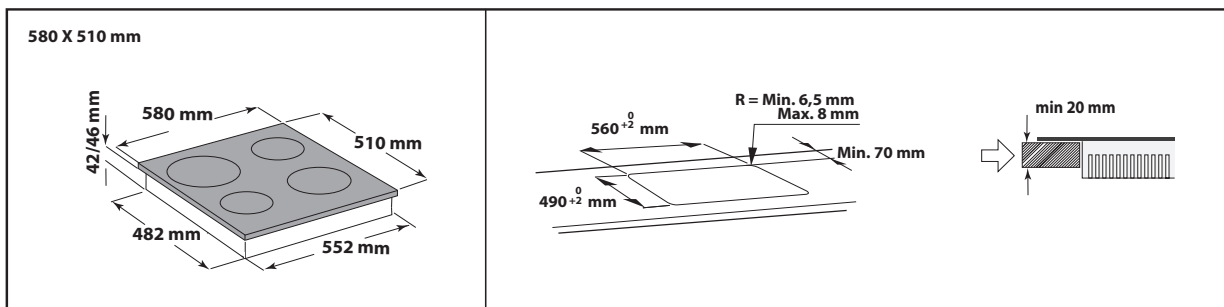
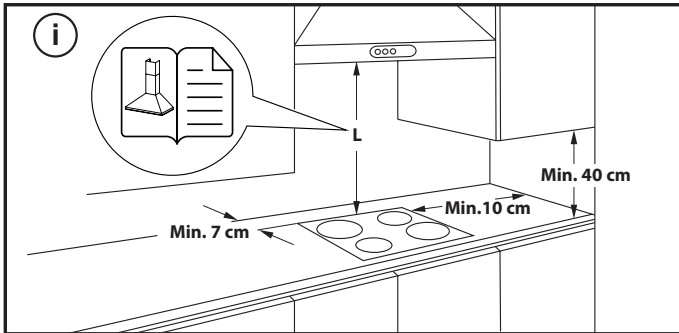

ELECTRICAL CONNECTION

Electrical connection must be made before connecting the appliance to the electricity supply.





Installation must be carried out by qualified personnel who know the current safety and installation regulations. Specifically, installation must be carried out in compliance with the regulations of the local electricity supply company.

Make sure the voltage specified on the data plate located on the bottom of the appliance is the same as that of the home.

Regulations require that the appliance be earthed: use conductors (including the earth conductor) of the appropriate size only.

CONNECTION TO THE TERMINAL BLOCK

For the electrical connection, use an H05RR-F cable as specified in the table below.

SUPPLY VOLTAGE	CONDUCTORS AMOUNT x SIZE
220-240V ~ + 	3 x 4 mm ²
230-240V ~ + 	3 x 4 mm ² (Australia only)
220-240V 3~ + 	4 x 1,5 mm ²
380-415V 3N~ + 	5 x 1,5 mm ²
380-425V 2N~ + 	4 x 1,5 mm ²

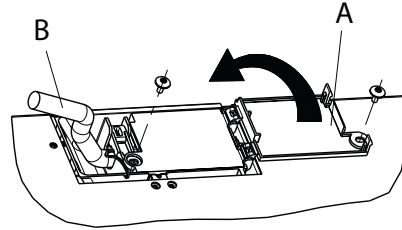

The appliance must be connected to the electricity supply by means of an all-pole disconnect switch with minimum contact gap of 3 mm.

ATTENTION: the power supply cable must be long enough to allow the cooktop to be removed from the worktop and must be positioned so as to avoid damage or overheating caused by contact with the base.

NOTE: the yellow/green earth wire must be connected to the terminal with the symbol  and must be longer than the other wires.

- Remove approx. 70 mm of the cable sheath from the power supply cable (B).
- Strip approx. 10 mm of sheath from the wires. Then insert the power supply cable into the cable clamp and connect the wires to the terminal block as indicated in the connection diagram placed close to the terminal block itself.
- Secure the power supply cable (B) by means of the cable clamp.
- Close the terminal board with the cover (A) securing it with the screw provided.
- After the electrical connection, fit the hob from the top and hook it to the support springs, according to the illustration.

PRODUCT DESCRIPTION

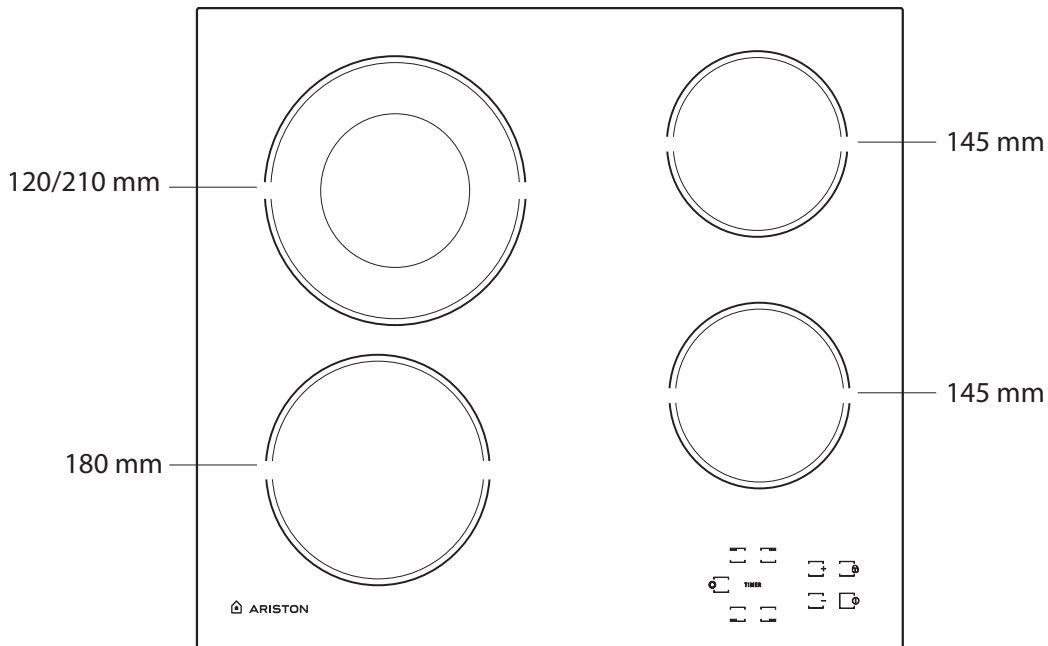

CONTROL PANEL

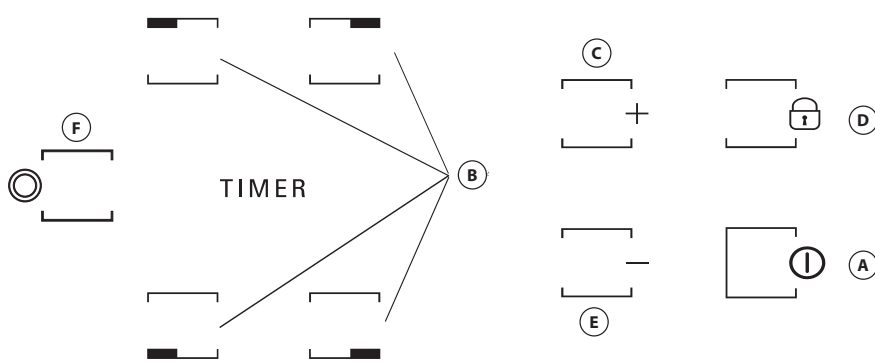

- A** On/Off
- B** Cooking zone and timer selection
- C-E** Heat setting increase and decrease
- D** Key lock
- F** Multiplezone Activation/Deactivation

FIRST TIME USE

Upon first installation, the control panel performs a functional test for about 1 second, after which it automatically switches to the "Key lock" function.

To deactivate the function, press and hold button "D"; an acoustic signal will sound and the corresponding led will turn off.

NOTE: If a reset occurs, repeat the procedure described above.

DAILY USE



SWITCHING THE HOB ON/OFF

To switch the hob on, keep button "A" pressed for approx. 2 seconds. The 4 cooking zone displays show "0". If within 20 seconds none of the cooking zones is activated, the hob switches off automatically as a safety precaution.

SWITCHING ON AND ADJUSTING COOKING ZONES

Press one of the buttons "B" corresponding to the cooking zone you intend to use. Select the heat setting required with buttons "E" or "C". The other selectable cooking settings go from 1 to 9. Press buttons +/- at the same time to cancel all settings.

Pressing button "+" when level 9 is reached, the "Booster" function is activated and the letter "A" appears on the display.

IMPORTANT: the control is deactivated 10 seconds after the heat setting has been selected.

To change the heat setting, first press the selection button "B" again, then proceed to change the setting, using buttons "E" or "C".



MULTIPLE ZONE

After selecting the desired zone and setting the level (as described in the previous section) press "F": an indicator above the button turns on, activating the additional zone.

The multiple zone can only be used if:

- The cooking zone is provided with multiple zone;
- The power level selected is greater than 0.

To deactivate the multiple zone, press button "B" of the desired zone, then press "F" again.

TIMER

To set the Timer function, select the desired cooking zone and power setting then press the cooking zone key again and a luminous dot will appear on the display of the timer-controlled cooking zone. The indication "00" blinks on the 2 displays. Press buttons "C" or "E" to set the time from 1 to 99.

IMPORTANT: after 10 seconds the timer displays will show the power setting of the other cooking zones.

To view the remaining cooking time, press the timer-controlled cooking zone key twice.



KEY LOCK

The Key lock function is switched on by holding down button "D" until a dot lights up above the function button. The Key lock function locks all the hob's other functions, with the exception of the On/Off button "A". The function remains on even after the hob is switched off and on again and can be deactivated by pressing button "D" again until the dot above the function button goes off.



RESIDUAL HEAT INDICATOR

When the cooking zone is switched off, the residual heat indicator "H" remains on or flashes alternating with "0" until the temperature of the hob returns within safety levels.

IMPORTANT: The hob's safety features include an automatic switching off function. Prolonged use of the same heat setting triggers automatic switch-off of the cooking zone (for example, after around 1 hour at maximum heat setting, the cooking zone switches off).

IMPORTANT: To avoid a permanent damage the hob:

- do not use pots with bottoms that are not flat;
- do not use metal pots with enamelled bottom;
- do not place hot pots/pans over the control panel.

MAINTENANCE AND CLEANING

Disconnect the appliance from the power supply.

- Do not use steam cleaning equipment.
- Do not use abrasive sponges or scouring pads as they may damage the glass.
- After each use, clean the hob (when it is cool) to remove any deposits and stains from food residue.
- Sugar or foods with a high sugar content can damage the hob and must be immediately removed.

- Salt, sugar and sand could scratch the glass surface.
- Use a soft cloth, absorbent kitchen paper or a specific hob cleaner (follow the Manufacturer's instructions).
- Spills of liquid in the cooking zones can cause the pots to move or vibrate.
- After cleaning the hob, dry thoroughly.

TROUBLESHOOTING

If the hob will not operate correctly, before calling the After-Sales Service, refer to the Troubleshooting Guide to determine the problem.

- Read and follow the instructions given in the section "Daily use".
- Check that the electricity supply has not been shut off.
- Dry the hob thoroughly after cleaning it.
- If a cooking zone has been selected and an "F" or an "ER" appear on the display followed by a number, contact the After Sales Service and inform them (with the exception of the message "F03" or "ER03"

that identifies the incorrect cleaning of the controls area. To solve the problem follow the instruction in the "Maintenance and Cleaning" paragraph).

- If the hob does not work following intensive use, the hob internal temperature is too high. Wait a few minutes until the hob cools down.

If after the above checks the fault still occurs, get in touch with the nearest After Sales Service.

AFTER-SALES SERVICE

In order to receive a more complete assistance, please register your product on www.aristonchannel.com.

BEFORE CALLING THE AFTER-SALES SERVICE:

1. See if you can solve the problem by yourself with the help of the suggestions given in the **TROUBLESHOOTING**.
2. Switch the appliance off and back on again to see if the fault persists.

- the service number (number after the word Service on the rating plate). The service number is also indicated on the guarantee booklet;



IF AFTER THE ABOVE CHECKS THE FAULT STILL OCCURS, GET IN TOUCH WITH THE NEAREST AFTER-SALES SERVICE.

To receive assistance, call the number shown on the warranty booklet or follow the instructions on the website www.aristonchannel.com.

When contacting our Client After sales service, always specify:

- a brief description of the fault;
- the type and exact model of the appliance;

- your full address;
- your telephone number.

If any repairs are required, please contact an authorized after-sales service (to guarantee that original spare parts will be used and repairs carried out correctly).

