

Instructions for use

KitchenAid

Safety instructions	4
Safeguarding the environment	5
Appliance description	6
Supplied with the product	6
Control panel	6
Preliminary instructions for use	7
Preparing vacuum bags and containers	8
Machine operation indications	10
Cleaning the product	11
Troubleshooting guide	12
After-sales Service	13
KitchenAid front panel in stainless steel with anti-fingerprint surface finish	13

Safety instructions

Important to be read and observed

Before using the appliance carefully read these safety instructions. Keep them nearby close at hand for future reference.

These instructions are also be available on website: docs.kitchenaid.eu

These instructions and the appliance itself provide important safety warnings, to be observed at all times.

The manufacturer declines any liability for failure to observe these safety instructions, for inappropriate use of the appliance or incorrect setting of controls.

Safety warnings

Very young (0-3 years) and young children (3-8 years) shall be kept away from the appliance unless continuously supervised.

Children from 8 years old and above and persons with reduced physical, sensory or mental capabilities or lack of experience and knowledge can use this appliance only if they are supervised or have been given instructions on safe use and understand the hazards involved. Children must not play with the appliance. Cleaning and user maintenance must not be carried out by children without supervision.

Permitted use

CAUTION: The appliance is not intended to be operated by means of an external timer or separate remote controlled system. This appliance is solely for domestic, not professional use. Do not use the appliance outdoors. Do not store explosive or flammable substances such as

aerosol cans and do not place or use gasoline or other flammable materials in or near the appliance: a fire may break out if the appliance is inadvertently switched on.

Only use KitchenAid brand bags for vacuum packaging and purpose-designed KitchenAid containers. Commercially available bags for food storage are not suitable for heat sealing and cannot guarantee a vacuum for a sufficient period of time.

Never hang anything heavy on the handle affixed to the machine panel.

Installation

The appliance must be handled and installed by two or more persons.

Use protective gloves to unpack and install the appliance.

Installation and repairs must be carried out by a qualified technician, in compliance with the manufacturer's instructions and local safety regulations. Do not repair or replace any part of the appliance unless specifically stated in the user manual.

Children should not perform installation operations. Keep children away during installation. Keep the packaging materials (plastic bags, polystyrene parts, etc.) out of reach of children, during and after the installation.

After unpacking the appliance, make sure that it has not been damaged during transport and that the lid closes perfectly. In the event of problems, contact the dealer or your nearest After-sales Service.

The appliance must be disconnected from the power supply before any installation operation.

During installation, make sure the appliance does not damage the power cable.

Only activate the appliance when the installation has been completed.

Electrical warnings

For installation to comply with current safety regulations, an omnipolar switch with minimum contact gap of 3 mm is required and the appliance must be earthed. If the power cable is damaged, replace with an identical one. The power cable must only be replaced by a qualified technician in compliance with the manufacturer instruction and current safety regulations. Contact an authorized service center.

Check that the voltage on the rating plate corresponds to the voltage of your home. The rating plate is located on the left hand side of the appliance. If the fitted plug is not suitable for your socket outlet, contact a qualified technician.

The power cable must be long enough to connect the appliance, once fitted in its housing, to the main power supply. Do not pull the power supply cable.

Do not use extension leads, multiple sockets or adapters.

Do not operate this appliance if it has a damaged mains cord or plug, if it is not working properly, or if it has been damaged or dropped.

Keep the cord away from hot surfaces.

The electrical components must not be accessible to the user after installation.

Do not touch the appliance with any wet part of the body and do not operate it when barefoot.

Cleaning and maintenance

Never use steam cleaning equipment.

Wear protective gloves for cleaning and maintenance.

The appliance must be disconnected from the power supply before any maintenance operation.

Safeguarding the environment

Disposal of packaging materials

The packaging material is 100% recyclable and is marked with the recycle symbol . The various parts of the packaging must therefore be disposed of responsibly and in full compliance with local authority regulations governing waste disposal.

Scrapping of household appliances

When scrapping the appliance, make it unusable by cutting off the power cable and removing the doors and shelves (if present) so that children cannot easily climb inside and become trapped. This appliance is manufactured with recyclable  or reusable materials. Dispose of it in accordance with local waste disposal regulations.

For further information on the treatment, recovery and recycling of household electrical appliances, contact your competent local authority, the collection service for household waste or the store where you purchase the appliance.

This appliance is marked in compliance with European Directive 2012/19/EU, Waste Electrical and Electronic Equipment (WEEE).

By ensuring this product is disposed of correctly, you will help prevent potential negative consequences for the environment and human health, which could otherwise be caused by inappropriate waste handling of this product.

The symbol  on the product or on the accompanying documentation indicates that it should not be treated as domestic waste but must be taken to an appropriate collection center for the recycling of electrical and electronic equipment.

Appliance description

- 1) Pull-out appliance body which includes vacuum chamber and relative lid;
- 2) control panel;
- 3) vacuum chamber lid;
- 4) vacuum chamber;
- 5) sealing bar;
- 6) ON/OFF switch.

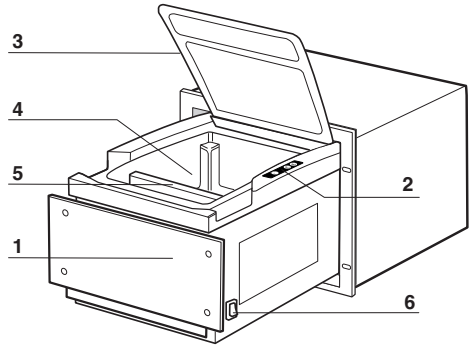

Supplied with the product

Vacuum bag



Control panel

- 1) Control panel display area
- 2) Led indicator lights
- 3) Button for KitchenAid vacuum bags.
- 4) Button for KitchenAid sous-vide for cooking
- 5) Button for KitchenAid vacuum containers.
- 6) Button for halting current cycle.

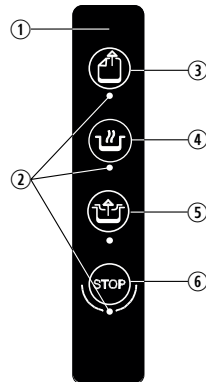

Preliminary instructions for use

Before starting up the machine, clean the vacuum chamber thoroughly with a soft, damp cloth. Repeat several times, rinsing the cloth in clean water each time. Do not use harsh detergents, steel scourers, scrapers or any abrasive, acidic or aggressive substances which could damage the surfaces of the vacuum chamber irreparably.

The appliance can vacuum pack food in two different ways:

1. Vacuum packing using KitchenAid bags

KitchenAid bags are suitable for packing non-delicate food products which are not easily crushed, such as meat, cold cuts, hard cheese, pulses, etc.

The bags are available in three different sizes: 15x25 cm, 20x20 cm and 25x35 cm, and can be purchased from Ka after-sales service or the website www.KitchenAid.eu

Store the bags in a cool, dry place, away from sources of light and heat.

KitchenAid bags are disposable: after use, discard them, complying with local regulations on the disposal of plastics.

KitchenAid bags are not suitable for cooking.

2. Vacuum packing using KitchenAid containers (can be purchased at After-sales Service)

KitchenAid vacuum containers are useful for storing delicate foods which easily crushed, and for storing liquid foodstuffs.

KitchenAid vacuum containers are not suitable for cooking and to be stored in the freezer. For better performances it's advisable to use the specific cycle for containers only.

Do not try to vacuum pack foods which are already old or nutritionally lacking: you cannot recover quality which has already been lost.

Only vacuum pack fresh, quality produce.

- Food which has been kept at ambient temperature for an excessive period of time or which has only just been cooked or prepared, loses its initial moisture and properties (colour, aroma, flavour, etc..). Consequently, it is best to vacuum pack food which has been chilled at length in the refrigerator until its temperature reaches +4/+6 °C (standard refrigerator temperature).
- When using vacuum bags for raw and cooked foods, remember to distribute food evenly inside the bags to facilitate removal of air. In addition, do not overfill the bags since this can interfere with sealing, resulting in bags which are not airtight. In this case the vacuum would not last: repeat the procedure with a new bag and check the seal has no openings or damage.
- Fill the bags 2/3 full at most with the food to be packed.

Preparing vacuum bags and containers

Using KitchenAid vacuum bags

1. Open the drawer fully (until it clicks).
2. Switch the machine on using the switch on the front right hand side.
3. Select the size of KitchenAid bag best suited to the dimensions of the food (15x25 or 20x20).
4. Open the lid, making sure the vacuum chamber is dry. When placing food in the bag, take care not to get the bag dirty or wet next to the opening, as this could result in an ineffective seal.
5. Position the support grille in the machine compartment as shown, with the bag in the centre of the grille, again as shown in the figure; if necessary, angle the grille so that it slopes slightly, as this will prevent any food spillage during the vacuum cycle. For large items of food, it may be necessary to remove the grille in order to gain additional space inside the vacuum chamber.

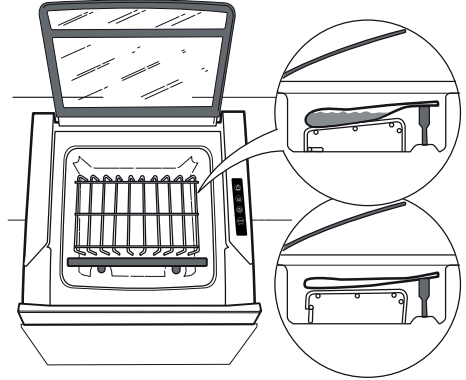

6. Line up the dotted line on the bag with the sealing bar. Make sure the edges are positioned on the bar without any wrinkles or folds.

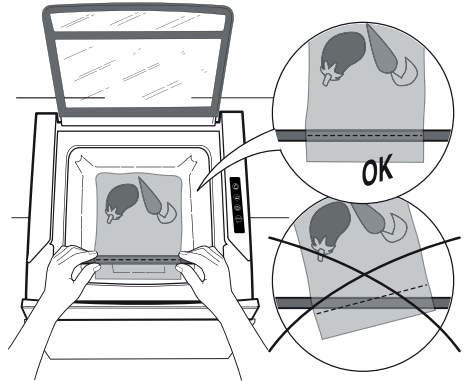

7. Close the lid and hold it down while at the same time selecting the bag cycle. Keep the lid pressed down for a few moments. In this way the lid will remain shut and tight to the seal for the duration of the cycle.

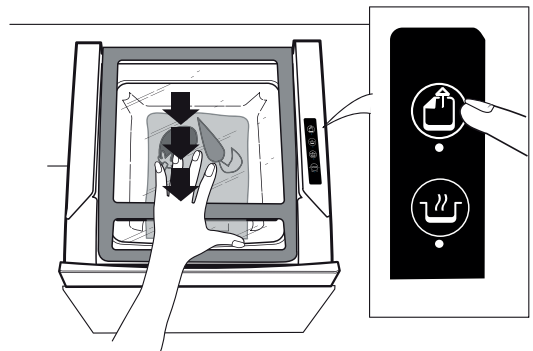

A perfect seal is essential in order to maintain the vacuum conditions in the bag. This can be identified by a clearly visible seal with no sign of any burns.

Always check that the seal is on top of or parallel to the dotted line on the KitchenAid bag.

Moreover, check the effectiveness of the seal: after sealing, it must not be possible to pull the edges of the bag apart. If this is not the case, transfer the food into another bag and repeat the vacuum packing procedure.

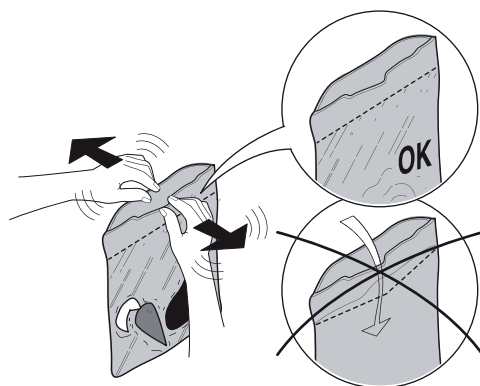

For optimum management of bags and food contained in them, write the packing date and contents on the space provided above the seal and return it to the refrigerator or freezer.

Using KitchenAid vacuum containers (can be purchased at After-sales Service)

For liquid foods or delicate produce which is easily crushed, use the special KitchenAid vacuum containers.

Only $\frac{3}{4}$ fill the containers.

1. To prepare a vacuum container, place the food inside and fit the lid on the container.
2. Position the container inside the vacuum chamber, in the centre of the compartment located in the base.
3. Close the lid and at the same time select the vacuum container cycle, holding the machine's glass lid down for a few moments: in this way the lid will remain shut and tight to the seal for the duration of the cycle. At the end of the cycle, return the container to the refrigerator only.

To open containers, turn the valve on the lid in the direction indicated by the arrow: this will let air back into the container and enable the lid to be removed with ease.

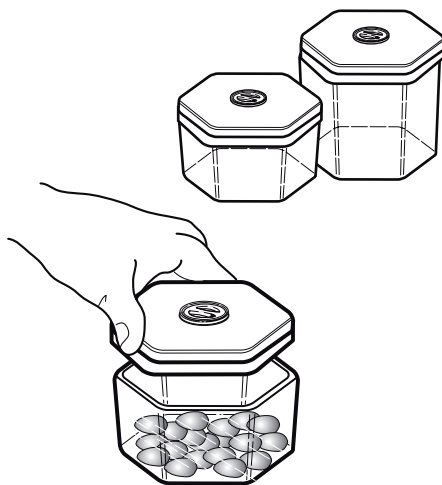



Sous-vide for cooking

Once the pack has been prepared inside the vacuum chamber as described in the "Preparation" chapter, close the lid exerting a slight pressure on the front and at the same time select the  key. The cooking vacuum cycle is started.

An acoustic signal (short beep) is emitted on cycle start.

The cycle proceeds automatically in the following order:

The evacuation phase is signalled by the  luminous indicator of the key flashing.

The sealing phase is signalled by the luminous indicator key  on.

During the successive unload phase, all of the luminous indicators go back to initial switch-on situation.

- When the vacuum chamber is decompressed, it is possible to open the lid and extract the sealed bag.
- As in the case of the preservation vacuum cycle, in the cooking vacuum cycle the product is tightly wrapped and compressed by the bag.
- An acoustic signal (short beep) is emitted at the end of the cycle, indicating that the machine is ready for a new cycle.
- By pressing the  key during the air evacuation phase, the appliance passes to the sealing phase in advance.

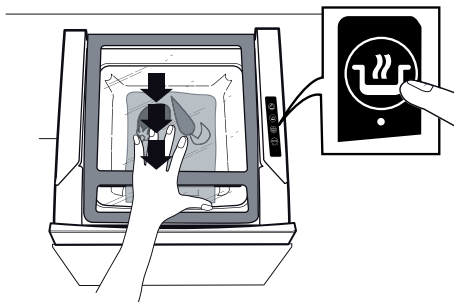
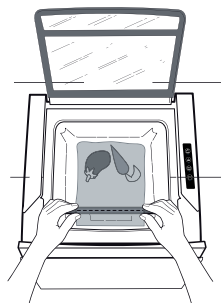

Machine operation indications

Switching On (pulling the drawer out to working position)

Always pull the drawer out to its full extension so that the glass lid can open fully.

Switch the machine on using the On switch on the front right hand side.

The control panel leds light up and a brief acoustic signal indicates the machine has been switched on. At this point the machine runs a set-up cycle lasting approximately 2 seconds; do not press any buttons until set-up has been completed.

Vacuum Cycle for Kitchen Aid bags

At the start of each cycle, a brief acoustic signal is emitted.

The cycle automatically proceeds as follows:

- The air extraction phase is indicated by the flashing of the function button. This phase lasts approximately 2 minutes and 30 seconds.
- The heat sealing phase is indicated by the function button led remaining lit. This phase lasts 9 seconds. This is followed by a cooling phase lasting approx. 5 seconds.
- During the subsequent exhaust phase all the led indicators return to their initial state. The exhaust valve remains open for 20 seconds. During this time, no function can be selected.
- Once the vacuum chamber is decompressed, the lid can be opened and the sealed bag removed.
- At the end of the cycle, a brief acoustic signal is emitted, indicating that the machine is ready to perform another cycle.
- The total duration of the cycle is about 3 minutes (to reopening of the glass lid)

The cycle can be stopped in advance by pressing the button . In this case, the machine will not proceed with sealing and the chamber will be decompressed. Wait for approximately 20 seconds and the acoustic signal before starting another cycle.

Vacuum cycle for KitchenAid containers

At the start of each cycle, a brief acoustic signal is emitted.

The cycle automatically proceeds as follows:

- The vacuum phase is indicated by the function button led flashing. This phase lasts approximately 45 seconds.
- During the subsequent exhaust phase all the led indicators return to their initial state. The exhaust valve remains open for 20 seconds. During this time, no function can be selected.
- Once the vacuum chamber is decompressed, the lid can be opened and the vacuum container removed.
- At the end of the cycle, a brief acoustic signal is emitted, indicating that the machine is ready to perform another cycle. The chamber is decompressed, enabling the container to be removed.
- The total duration of the cycle is about 1 minute (to reopening of the glass lid)

The cycle can be stopped in advance by pressing the button . The chamber is decompressed and the glass lid will lift. Wait for approximately 20 seconds and the acoustic signal before starting another cycle.

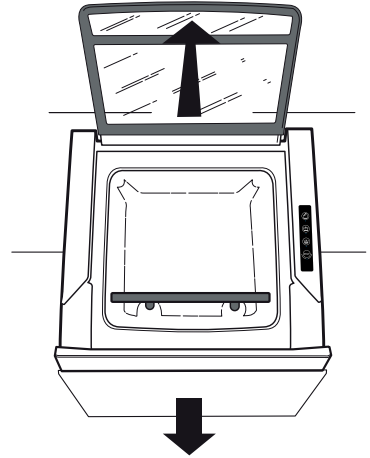

Cleaning the product

Clean the vacuum packing machine with a soft cloth or sponge and neutral detergent.

In order to ensure hygiene and safeguard the quality of foodstuffs packed, the vacuum chamber and glass lid must be cleaned after each use.

Use a soft cloth or non-abrasive sponge and neutral detergent.

Once a month, clean the sealing bar in order to remove any residue which could negatively impact the quality of bag sealing.

To facilitate this procedure, lift the sealing bar (A) up, removing it from the two pins (B).

Use a soft cloth or non-abrasive sponge and neutral detergent.

After cleaning, fit the bar on the pins (B), lining up the two holes on the underside of the bar and make sure it engages securely without removing the black teflon pipe.

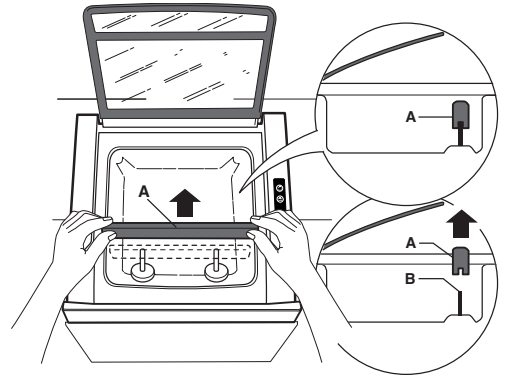

If you plan not to use the machine for a prolonged period of time, clean it thoroughly. Before using again, unplug and clean it thoroughly again and restart.

Automatic dehumidification cycle

It is advisable to perform a dehumidification cycle, once a week for intensive usage, by close the lid of the vacuum chamber as normal and keeping it down, press the button for the Kitchen Aid bag cycle for 5 seconds; this cycle will last about 20 minutes.

Troubleshooting guide

Problem solving table

FAULT	POSSIBLE CAUSES	SOLUTION
All the led indicators on the control panel flash.	Overheating.	Switch the machine off and wait for approximately 15 minutes to allow cooling and automatic reset of the thermal overload cutouts. If the problem persists when the machine is switched back on again, call Kitchen Aid after sales service.
The led indicator of the STOP button flashes, accompanied by an intermittent acoustic signal	Insufficient vacuum in the chamber.	<ul style="list-style-type: none"> • Lid not pressed at start of cycle. • Lid of vacuum container not properly fitted. • Lid seal worn or incorrectly positioned. • Switch the machine off and wait for approximately 15 minutes. If the problem persists when the machine is switched back on again, call the Kitchen Aid after sales service.
Upon switching on, all the led indicators on the control panel flash for 3 seconds and a long acoustic signal is emitted.	Pump oil replacement reminder.	Call the Kitchen Aid after sales service.
The cycle starts (buttons flash) but the pump does not work.	Overheating.	Switch the machine off and wait for approximately 15 minutes before switching back on again. If the problem persists when the machine is switched back on again, call the Kitchen Aid after sales service.
The machine does not switch on	No power supply.	Check electrical connection. If the problem persists when the machine is switched back on again, call the Kitchen Aid after sales service.
Insufficient vacuum in bag	<ol style="list-style-type: none"> 1. Irregular or insufficient seal on bag. 2. Irregular sealing strip 3. Bag dirty or burst. 4. Bag of unsuitable size for the product contained inside. 5. Poor pump performance. 	<ol style="list-style-type: none"> 1. Position the bag correctly. 2. Check the state of the teflon covering. 3. Change bag. 4. Select a bag in which the product does not exceed 2/3 the volume. If the problem persists when the machine is switched back on again, call the Kitchen Aid after sales service
The machine does not seal the bags.	<ol style="list-style-type: none"> 1. Dirty contacts. 2. Sealing bar element broken. 3. No power supply. 	Release the sealing bar from its two pins and, clean the two holes on the bar. If the problem persists when the machine is switched back on again, call the Kitchen Aid after sales service.

After-sales Service

Before contacting KitchenAid After-sales Service:

1. See if you can eliminate the problem on your own by referring to the "Troubleshooting guide".
2. Turn the appliance off and on again to check if the problem has been eliminated.

If after the above checks the fault persists, contact your nearest After-sales Service.

Always specify:

- a brief description of the fault;
- the type and exact model of the appliance;
- the service number (number after the word Service on the rating plate), located on the left of the appliance, visible when fully opened. The service number is also indicated on the guarantee booklet;

SERVICE 0000 000 00000



- your full address;
- your telephone number.

If repair work has to be carried out, contact an authorized **After-sales Service** (use of original spare parts and proper repair is guaranteed).

Failure to comply with these instructions may compromise the safety and quality of the product.

KitchenAid front panel in stainless steel with anti-fingerprint surface finish

This vacuum packing machine is designed to be integrated with your kitchen: the front panel can therefore be fitted by your installer and must have the following standard dimensions (see installation diagrams, not provided with the product).

595 mm x 455 mm

The KitchenAid front panel, made of stainless steel with an anti-fingerprint surface finish, is available as an accessory. To order it, contact your After-sales Service.



FOR THE WAY IT'S MADE.

Printed in Italy
02/17

400011092273

