

THANK YOU FOR BUYING A INDESIT PRODUCT

In order to receive a more complete assistance, please register your product on www.indesit.com/register



Before using the appliance carefully read the Safety Instruction.

Before using the machine, it is imperative that the transport bolts are removed. For more detailed instructions on how to remove them, see the Installation Guide.

CONTROL PANEL

1. ON/OFF button
2. OPTION buttons and indicator lights
3. START/PAUSE button and indicator light
4. WASH CYCLE PHASE/ DELAY TIMER indicator lights
5. DOOR LOCKED indicator light
6. SPIN knob
7. TEMPERATURE knob
8. WASH CYCLE SELECTOR KNOB
9. Detergent dispenser drawer

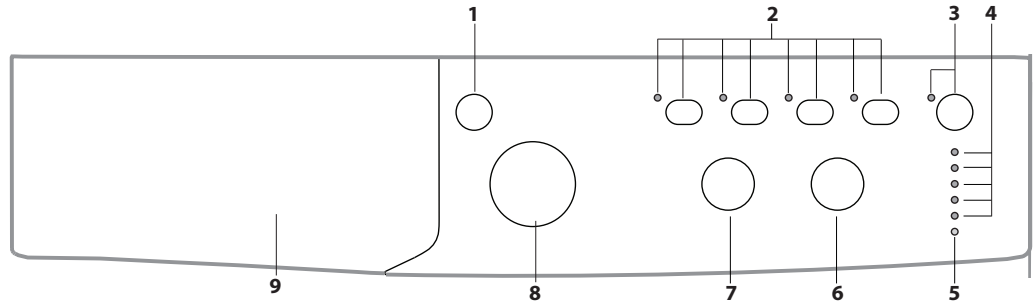

WASH CYCLE TABLE

Maximum load 6 kg Power input in off mode 0.5 W / in left-on mode 8 W							Detergents and Additives		Recommended detergent		Residual dampness % (***)	Energy consumption kWh	Total water l	Laundry temperature °C
Wash cycle	Temperature		Maxim spin (r.p.m.)	Max. load (kg)	Duration (h : m)	Wash	Fabric softener	Powder	Liquid					
	Setting	Range				2	3							
1	White	60°C	☼ - 90°C	1200	6	2:30	●	○	✓	✓	64	0.56	41	55
2	Mix Colours	40°C	☼ - 40°C	1200	6	1:25	●	○	-	✓	-	-	-	-
3	Synthetics (3)	40°C	☼ - 60°C	1200	3	2:55	●	○	✓	✓	40	0.80	55	43
4	Cotton (2)	40°C	☼ - 60°C	1200	6	4:00	●	○	✓	✓	58	1.00	53	45
5	Delicate	30°C	☼ - 30°C	0	1	1:10	●	○	-	✓	-	-	-	-
6	Wool	40°C	☼ - 40°C	800	1	1:10	●	○	-	✓	-	-	-	-
7	Mix Light	20°C	☼ - 20°C	1000	6	2:00	●	○	-	✓	-	-	-	-
8	Rapid 20'	20°C	☼ - 20°C	800	1.5	0:20	●	○	-	✓	-	-	-	-
9	Sport Intensive	30°C	☼ - 30°C	600	2	1:25	●	○	-	✓	-	-	-	-
10	Sport Light	30°C	☼ - 30°C	600	2	1:00	●	○	-	✓	-	-	-	-
11	Sport Shoes	30°C	☼ - 30°C	600	Max. 2 Pairs	0:55	●	○	-	✓	-	-	-	-
12	Jeans	40°C	☼ - 40°C	800	2	1:05	●	○	-	✓	-	-	-	-
13	Eco 40-60 (1)	40°C	40°C	1151	6	3:15	●	○	✓	✓	53	1.00	50	37
				1151	3	2:35	●	○	✓	✓	53	0.70	38	35
				1151	1.5	2:30	●	○	✓	✓	53	0.65	38	35
14	20°C	20°C	☼ - 20°C	1200	6	1:50	●	○	-	✓	64	0.16	25	22
15	Rinse+Spin	-	-	1200	6	0:55	-	○	-	-	-	-	-	-
16	Spin+Drain *	-	-	1200	6	0:10	-	-	-	-	-	-	-	-
4	Eco Cotton (4)	60 °C	60 °C	1200	6	3:30	●	○	✓	✓	53	0.80	38	-
		40 °C	40 °C	1200	6	4:00	●	○	✓	✓	58	1.00	53	-

The cycle duration indicated on the display or instruction manual is an estimate based on standard conditions. The actual duration may vary in relation to several factors, such as the temperature and pressure of the incoming water, ambient temperature, amount of detergent, load quantity and type, load balancing and any additional options selected. The values given for programmes other than the Eco 40-60 programme are indicative only.

1) Eco 40-60 - Test wash cycle in compliance with EU Ecodesign regulation 2019/2014. The most efficient programme in terms of energy and water consumption for washing normally soiled cotton laundry. Note: for the Eco 40-60 program in the WASH CYCLE TABLE the value of the maximum effective spin is shown.

For all testing institutes:

- 2) Long cotton cycle: set cycle 4 at a temperature of 40°C.
- 3) Long synthetics cycle: set cycle 3 at a temperature of 40°C.

4) Eco Cotton - Test wash cycles in compliance with regulations 1061/2010. Set 4 wash cycle at a temperature of 40°C or 60°C to access this cycles.

* By selecting the 16 cycle and excluding the spin cycle, the washing machine will drain only.

** After programme end and spinning with maximum selectable spin speed, in default programme setting.

PRODUCT DESCRIPTION

1. Top
2. Detergent dispenser drawer
3. Control panel
4. Handle
5. Porthole door
6. Drain pump (behind the plinth)
7. Plinth (removable)
8. Adjustable feet (2)

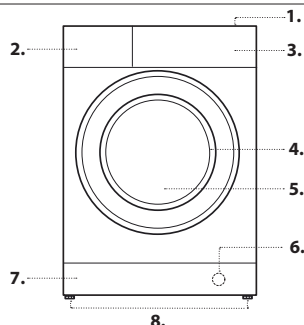

DETERGENT DISPENSER DRAWER

Compartment 1:

Do not pour detergent into the compartment 1. Detergent should only be poured into the compartment 2.

Compartment 2: Washing detergent (powder or liquid)

Liquid detergent should only be poured in immediately prior to the start of the wash cycle. **Compartment 3: Additives (fabric softener, etc.)** The fabric softener should not overflow the grid.

! Use powder detergent for white cotton garments, for pre-washing, and for washing at temperatures over 60°C. ! Follow the instructions given on the detergent packaging.

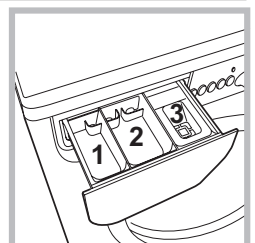

WASH CYCLES

Follow the instructions on the symbols of the garment's wash care label. The value indicated in the symbol is the maximum recommended temperature for washing the garment.

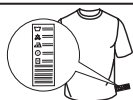

White

extremely soiled whites.

Mix Colours

A 40°C cycle that helps to preserve colours, suitable for cotton or synthetic coloured garments. It allows for reducing electricity consumption for heating the water while guaranteeing good washing results. Suitable for lightly soiled garments.

Synthetics

Specific for synthetic items. If the dirt is difficult to remove, the temperature can be increased up to 60° and powder detergent can be used too.

Cotton

Suitable for washing towels, underwear, table cloths, etc. made of resistant linen and cotton that are moderately to heavily soiled.

Delicate

use programme 5 to wash very delicate garments. It is advisable to turn the garments inside out before washing them. For best results, use liquid detergent on delicate garments.

Wool

all wool garments can be washed using programme 6, even those carrying the "hand-wash only"  label. For best results, use special detergents and do not exceed 1 kg of laundry.

Mix Light

ideal for mixed loads (cotton and synthetics) with a normal soil level. The effective performance levels achieved at cold temperatures are guaranteed by a mechanical action which operates at varying speed, across set average intervals.

Rapid 20'

ideal for refreshing and washing lightly soiled garments in a few minutes. It lasts just 20 minutes and therefore saves both time and energy. It can be used to wash different types of fabrics together (except for wool and silk), with a maximum load of 1.5 kg.

Sport Intensive

is for washing heavily soiled sports clothing fabrics (tracksuits, shorts, etc.); for best results, we recommend not exceeding the maximum load indicated in the "Wash Cycle Table".

Sport Light

is for washing lightly soiled sports clothing fabrics (tracksuits, shorts, etc.); for best results, we recommend not exceeding the maximum load indicated in the "Wash Cycle Table". We recommend using a liquid detergent and dosage suitable for a half-load.

Sport Shoes

is for washing sports shoes; for best results, do not wash more than 2 pairs simultaneously.

Jeans

Turn garments inside-out before washing and use a liquid detergent.

Eco 40-60

For washing normally soiled cotton garments declared to be washable at 40°C or 60°C, together in the same cycle. This is the standard cotton programme and the most efficient in terms of water and energy consumption.

20°C

For washing lightly soiled cotton garments, at a temperature of 20°C.

Rinse+Spin

designed for rinsing and spinning.

Spin+Drain

designed to spin and drain the water.

Eco Cotton

Suitable for washing moderately soiled cotton garments. At 40°C and 60°C it is the standard cycle for washing cotton garments, and is the most efficient in terms of combined water and electricity consumption.

INDICATOR LIGHTS

The indicator lights provide important information. This is what they can tell you:

Delayed start

If the DELAY TIMER function has been activated, after the wash cycle has been started the indicator light corresponding to the selected delay period will begin to flash:

3h 

6h 

9h 

12h 

As time passes, the remaining delay will be displayed and the corresponding indicator light will flash:

3h 

6h 

9h 

12h 

The set programme will start once the selected time delay has expired.

Wash cycle phase indicator lights

Once the desired wash cycle has been selected and has begun, the indicator lights switch on one by one to indicate which phase of the cycle is currently in progress.

Wash



Rinse



Spin



Drain





End of wash cycle



DOOR LOCKED INDICATOR

When lit, the symbol indicates that the door is locked. To prevent any damage, wait until the symbol turns off before opening the door.



To open the door while a cycle is in progress, press the START/PAUSE button ; if the  symbol is off, the door can be opened.

FIRST-TIME USE

Once the appliance has been installed, and before it is used for the first time, run a wash cycle with detergent and no laundry, by setting the "1" cycle.

DAILY USE

Prepare the laundry by following the suggestions appearing under the "TIPS AND SUGGESTIONS" section.

- Press the ON/OFF button ; the START/PAUSE indicator light  will flash slowly green.

- Open the door. Load the laundry while making sure not to exceed the maximum load quantity indicated in the Wash Cycle Table.

- Pull out the detergent dispenser drawer and pour the detergent into the relevant compartments as described in "DETERGENT DISPENSER DRAWER" section.



- Close the door.

- Select the desired wash cycle.



- Set the washing temperature.

- Set the spin speed.





- Select the desired options.

- Press the START/PAUSE  button to start the wash cycle; the relative indicator light will light up steady green and the door will lock ( symbol on).



PAUSING A CYCLE

To pause the wash cycle, press the START/PAUSE  button again; the indicator light will flash amber. If the  symbol is not lit, the door may be opened. To start the wash cycle from the point at which it was interrupted, press the START/PAUSE  button again.

OPENING THE DOOR, IF NECESSARY



Once a cycle starts, the  symbol turns on to signal that the door cannot be opened. While a wash cycle is running, the door remains locked. To open the door while a cycle is under way, for example, to add or remove garments, press the START/PAUSE  button to pause the cycle; the indicator light will flash amber. If the  symbol is not lit, the door may be opened. Press the START/PAUSE  button again to continue the cycle.

CHANGING A RUNNING WASH CYCLE

To change a wash cycle while it is in progress, pause the washing machine using the START/PAUSE  button (the relative indicator light will flash amber), then select the desired cycle and press the START/PAUSE  button again.

! To cancel a cycle that has already begun, press and hold the ON/OFF  button. The cycle will be stopped and the machine will switch off.

END OF THE CYCLE

Once the cycle terminates the END indicator light will light up; when the  indicator light switches off, the door may be opened. If you do not press ON/OFF  button, the washing machine will switch off automatically after about a 10 minutes. Close the water tap, open the door and unload the washing machine. Leave the door ajar to allow the drum to dry.

OPTIONS

- If the selected function is not compatible with the programmed wash cycle, the corresponding indicator light will flash and the function will not be activated.

- If the selected function is not compatible with another function which has been selected previously, the indicator light corresponding to the first function selected will flash and only the second function will be activated; the indicator light corresponding to the enabled option will remain lit.

Time Saver

Selecting this option enables you to suitably adjust drum rotation, temperature and water to a reduced load of lightly soiled cotton and synthetic fabrics. **Time Saver** enables you to wash in less time thereby saving water and electricity. We suggest using a liquid detergent suitably measured out to the load quantity.

Energy Saver

The Energy Saver function saves energy by not heating the water used to wash your laundry - an advantage both to the environment and to your energy bill. Instead, intensified wash action and water optimisation ensure great wash results in the same average time of a standard cycle. For the best washing results we recommend the usage of a liquid detergent.

Extra Rinse

By selecting this option, the efficiency of the rinse is increased and optimal detergent removal is guaranteed. It is particularly useful for sensitive skin.

Delay Timer

This timer delays the start time of the wash cycle by up to 12 hours. Press the button repeatedly until the indicator light corresponding to the desired delay time switches on. The fifth time the button is pressed, the function will be disabled.

N.B. Once the START/PAUSE >|| button has been pressed, the delay time can only be modified by decreasing it until launching the set programme.

Temperature

Turn the TEMPERATURE knob to set the wash temperature (see Wash Cycle Table).

The temperature may be lowered, or even set to a cold wash ❄.

The washing machine will automatically prevent you from selecting a temperature which is higher than the maximum value set for each wash cycle.

Spin

Turn the SPIN SPEED knob to set the spin speed for the selected wash cycle.

The spin speed may be lowered, or the spin cycle can be excluded altogether by selecting the symbol Ⓞ.

The washing machine will automatically prevent you from selecting a spin speed which is higher than the maximum speed set for each wash cycle.

TIPS AND SUGGESTIONS

Divide the laundry according to:

Type of fabric (cotton, mixed fibres, synthetics, wool, garments to be hand-washed). Colour (separate coloured garments from whites, wash new coloured garments separately). Delicates (small garments – such as nylon stockings – and items with hooks – such as bras: insert them in a fabric bag).

Empty the pockets:

Objects such as coins or lighters can damage the washing machine and the drum. Check all buttons.

Follow the dosage recommendation / additives

It optimizes the cleaning result, it avoids irritating residues of surplus detergent in your laundry and it saves money by avoiding waste of surplus detergent.

Use low temperature and longer duration

The most efficient programmes in terms of energy consumption are generally those that perform at lower temperatures and longer duration.

Observe the load sizes

Load your washing machine up to the capacity indicated in the "Wash Cycle Table" table to save water and energy.

Noise and remaining moisture content

They are influenced by the spinning speed: the higher the spinning speed in the spinning phase, the higher the noise and the lower the remaining moisture content.

CARE AND MAINTENANCE

Before performing cleaning and maintenance, switch the washing machine off and disconnect it from the mains power. Do not use flammable liquids to clean the washing machine. Clean and maintain your washing machine periodically (at least 4 times per year).

Disconnect the water and power supplies

Close the water tap after every wash. This will limit wear on the hydraulic system inside the washing machine and help to prevent leaks.

Unplug the washing machine when cleaning it and during all maintenance work.

Clean the washing machine

The outer parts and rubber components of the appliance can be cleaned using a soft cloth soaked in lukewarm soapy water. Do not use solvents or abrasives.

Clean the detergent dispenser drawer

Wash it under running water; this operation should be repeated frequently.

Care for the door and drum

Always leave the porthole door ajar in order to prevent unpleasant odours from forming.

Clean the pump

The washing machine is fitted with a auto-cleaning pump that does not require any maintenance. Small items (such as coins or buttons) may sometimes fall into the protective pre-chamber situated at the base of the pump.

! Make sure the wash cycle has ended and unplug the appliance.

To access the pre-chamber:

1. remove the cover panel on the front of the machine by first pressing it in the centre then pushing downwards on both sides to extract it;
2. loosen the drainage pump cover by turning it anti-clockwise: it is normal for some water to leak out;
3. clean the inside thoroughly;
4. screw the cover back on;
5. put the panel back in place, making sure the hooks slot in place before pushing the panel onto the appliance.

Check the water inlet hose

Check the water inlet hose at least once a year. If it is cracked or broken, it must be replaced: during wash cycles, the high pressure of the water could suddenly split the hose open.

! Never use hoses that have already been used.

LOAD BALANCING SYSTEM

Before every spin cycle, to avoid excessive vibrations before every spin and to distribute the load in a uniform manner, the drum rotates continuously at a speed which is slightly greater than the washing rotation speed. If, after several attempts, the load is not balanced correctly, the machine spins at a reduced spin speed. If the load is excessively unbalanced, the washing machine performs the distribution process instead of spinning. To encourage improved load distribution and balance, we recommend small and large garments are mixed in the load.

ACCESSORIES

Contact our Technical Assistance Service to check whether the following accessories are available for this washing machine model.

Stacking kit





With this accessory you can secure the tumble dryer to the upper part of your washing machine to save space and facilitate loading and unloading of the tumble dryer.

TRANSPORT AND HANDLING

Do not lift the washing machine by gripping it from the upper section. Unplug the appliance and close the water tap. Check that the door and detergent dispenser drawer are tightly closed. Detach the filling hose from the water tap then detach the drain hose. Empty all the water remaining in the hoses and secure the latter so that they do not get damaged during transport. Apply the transport bolts back on. Repeat, in reverse order, the transport bolt removal procedure described in the "Health & Safety and Installation Guides".

TROUBLESHOOTING

The washing machine may occasionally fail to work. Before contacting the Technical Assistance Service, make sure that the problem cannot be easily solved using the following list.

Anomalies	Possible causes / Solution
The washing machine does not start.	The appliance is not plugged into the socket, or not sufficiently to make contact.
	There is no power in the house.
The wash cycle does not start.	The washing machine door is not closed properly.
	The ON/OFF  button has not been pressed.
	The START/PAUSE  button has not been pressed.
	The water tap has not been opened.
	A delay has been set for the start time.
The machine does not fill with water or the indicator light for the first wash cycle stage flashes rapidly.	The water inlet hose is not connected to the tap.
	The hose is bent.
	The water tap has not been opened.
	There is no water supply in the house.
	The pressure is too low.
The washing machine continuously loads and unloads water.	The START/PAUSE  button has not been pressed.
	The drain hose is not fitted between 65 and 100 cm from the floor.
	The free end of the hose is immersed in water.
	The wall drainage system does not have a breather pipe. If the problem persists even after these checks, turn off the water tap, switch the appliance off and contact the Technical Assistance Service. If the home is on one of the upper floors of a building, there may be problems relating to back-siphonage, causing the washing machine to fill with water and drain continuously. Special anti-siphon valves are available in shops and help to prevent this inconvenience.
The washing machine does not drain or spin.	The cycle does not include drainage: with certain cycles it must be started manually.
	The drain hose is bent.
	The drainage duct is clogged.
The washing machine vibrates a lot during the spin cycle.	The drum was not unlocked correctly during installation.
	The washing machine is not level.
	The washing machine is tucked between furniture cabinets and the wall.
The washing machine leaks.	The water inlet hose is not screwed on properly.
	The detergent dispenser drawer is obstructed.
	The drain hose is not properly attached.
The "Options" indicator lights and the "START/PAUSE"  indicator light flash, while one of the "phase in progress" indicator lights and the "door locked" indicator light will remain lit in a fixed manner.	Switch off the machine and unplug it, wait for approximately 1 minute and then switch it back on again. If the problem persists, contact the Technical Assistance Service .
There is too much foam.	The detergent is not suitable for machine washing (it should be marked with "for washing machine use" or "hand wash and machine wash" or similar).
	Too much detergent was used.



You can download the Safety Instructions, Product Fiche and Energy data by:

- Visiting our website - <http://docs.indesit.eu>
- Using QR Code
- Alternatively, **contact our After-sales Service** (See phone number in the warranty booklet). When contacting our After-sales Service, please state the codes provided on your product's identification plate.
- For User's Repair & Maintenance Information visit www.indesit.com

The model information can be retrieved using the QR-Code reported in the energy label. The label also includes the model identifier that can be used to consult the portal of the registry at <https://eprel.ec.europa.eu>

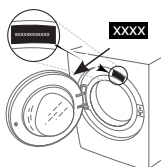

11475401