

INSTRUCTIONS FOR USE

BEFORE USING THE APPLIANCE	PAGE 180
SAFEGUARDING THE ENVIRONMENT	PAGE 180
PRECAUTIONS AND GENERAL RECOMMENDATIONS	PAGE 181
PRODUCT DESCRIPTION	PAGE 182
CONTROL PANEL DESCRIPTION	PAGE 183
HOW TO OPERATE THE FREEZER/ REFRIGERATOR	PAGE 185
USE OF THE ICE DISPENSER (ON SOME MODELS)	PAGE 189
USE OF THE AUTOMATIC ICE MAKER (ON SOME MODELS)	PAGE 190
USE OF THE WATER DISPENSER (ON SOME MODELS)	PAGE 191
WATER FILTER MONITORING AND REPLACEMENT FUNCTION (ON SOME MODELS)	PAGE 192
REFRIGERATOR COMPARTMENT AIR DISTRIBUTION SYSTEM	PAGE 194
GUIDE TO INTERNAL COMPONENTS	PAGE 195
GUIDE TO STORAGE AND THAWING OF FOOD	PAGE 196
COMMON ICE MAKER PROBLEMS	PAGE 198
MAINTENANCE AND CLEANING	PAGE 199
VACATION.....	PAGE 200
TROUBLESHOOTING GUIDE/ AFTER-SALES SERVICE	PAGE 201
AFTER-SALES SERVICE	PAGE 203
ELECTRICAL CONNECTION	PAGE 204

BEFORE USING THE APPLIANCE

- Your new appliance is designed exclusively for domestic use.

To get the most out of your new appliance, read the user handbook thoroughly. The handbook contains a description of the appliance and useful tips for storing food.

Keep this handbook for future consultation.

1. After unpacking, make sure that the appliance is undamaged and that the door closes properly. Any damage must be reported to your dealer within 24 hours after delivery of the appliance.
2. Wait at least two hours before switching the appliance on in order to ensure the refrigerant circuit is fully efficient.
3. Make sure that the installation and the electrical connection are carried out by a qualified technician according to the manufacturer's instructions and local safety regulations.
4. Clean the inside of the appliance before using it.

SAFEGUARDING THE ENVIRONMENT

1. Packing

The packaging material is 100% recyclable and carries the recycling symbol. Disposal must be carried out in accordance with local regulations for waste disposal.

Keep the packaging materials (plastic bags, polystyrene parts, etc.) out of reach of children, as they are potentially dangerous.

2. Scrapping

The appliance is manufactured using recyclable material.

Before scrapping, make the appliance unusable by cutting off the power cable and removing the doors and shelves so that children cannot easily climb inside the appliance.

Disposal must be carried out in accordance with local environmental regulations for waste disposal. Deliver the appliance immediately to an authorized dump; do not leave it unattended even for a few days, since it is potentially dangerous for children.

Information:

This appliance does not contain CFCs (replaced with R134a) or HFCs (replaced with R600a).

Appliances with Isobutane (R600a):

Isobutane is a natural gas with low environmental impact. Caution is required, however, since isobutane is flammable. Therefore, it is essential to ensure that refrigerant pipelines are not damaged.

Declaration of conformity

- This appliance is designed to store food and is manufactured in conformity with EEC directive No. 89/109/EEC, 90/128/EEC, 02/72/EEC.



- This appliance is designed, manufactured, and retailed in compliance with:
 - the safety objectives of the Low Voltage Directive 73/23/EEC;
 - the protection requirements of the "EMC" Directive 89/336/EEC amended by Directive 93/68/EEC;
 - the electrical safety of the appliance can only be guaranteed if the product is connected to an approved earth connection.

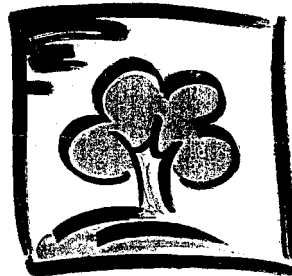

PRECAUTIONS AND GENERAL RECOMMENDATIONS

- Use the refrigerator compartment only for storing fresh food and beverages and use the freezer compartment only for storing frozen food, freezing fresh food and making ice cubes.
- After installation, make sure that the refrigerator does not stand on the power cable.
- Do not store glass containers with liquids in the freezer since they may burst.
- Do not eat ice cubes or ice lollies immediately after taking them out of the freezer since they may cause "cold" burns.
- Before carrying out any maintenance or cleaning, always unplug the appliance or disconnect the power supply.
- Make sure that your refrigerator is not near a heat source.
- Do not store or use gasoline or other flammable vapours and liquids in the vicinity of this or any other appliance. The fumes can create a fire hazard or explosion.
- To ensure proper ventilation leave a 1 cm space on both sides and above the refrigerator.
- Ensure that the vent outlets on the appliance casing or housing unit are unobstructed in order to allow correct air circulation.
- The appliance should be connected to a water supply that delivers drinkable or chemically purified water.
- Install and level the refrigerator on a floor that will hold the weight and in an area suitable for its size and use.
- Do not use the refrigerator in an area where the room temperature will fall below 13°C. Place it in a dry and well ventilated room.
- Be careful not to damage the floors when you move the appliance (e.g. parquet flooring).
- Do not use mechanical devices or any means other than those recommended by the manufacturer to speed up the defrosting process.
- Do not damage the refrigerant circuit.
- Do not use electrical appliances inside the freezer compartments, unless such appliances are specifically recommended by the manufacturer.
- This appliance is not designed for use by young children or the infirm.
- To avoid the risk of children being trapped and therefore suffocating, do not allow them to play or hide inside the refrigerator.
- The power cable may only be replaced by an authorized person.
- Do not use extension leads or adapters.
- Do not ingest the contents (non-toxic) of the ice packs (if provided).

PRODUCT DESCRIPTION

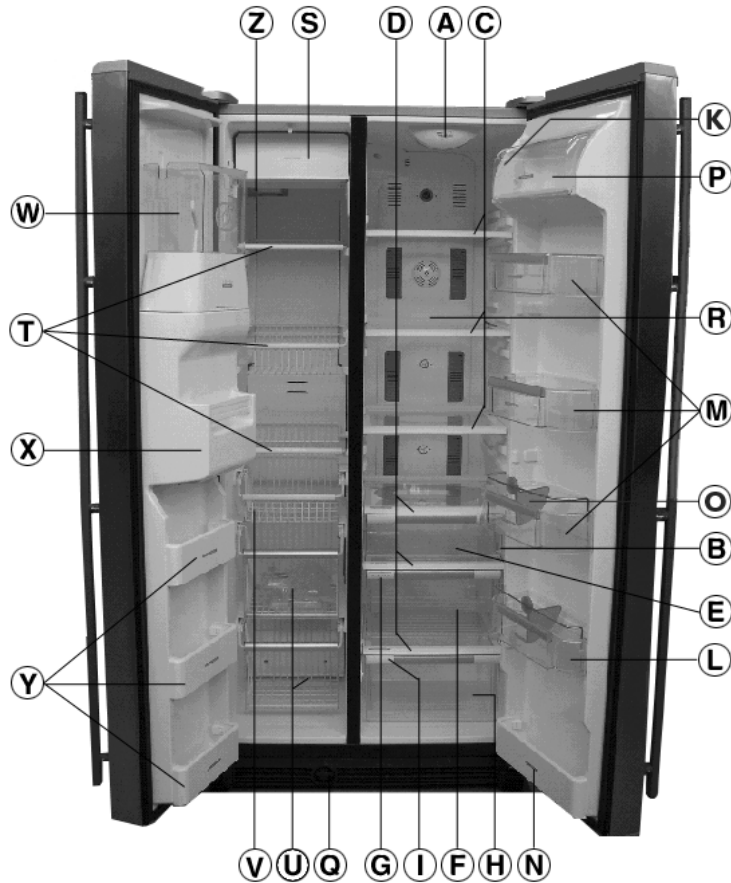

Freezer Compartment

- S.** Automatic ice maker
- T.** Grids
- U.** Bottom basket
- V.** Top basket
- W.** Ice cube bucket
- X.** Freezer inner door insert
- Y.** Freezer inner door tray
- Z.** Inside lamp

Refrigerator Compartment

- A.** Inside lamp
- B.** Intermediate light
- C.** Adjustable shelf
- D.** Drawer lid
- E.** Drawer
- F.** Crisper drawer
- G.** Crisper drawer adjustment
- H.** Meat drawer
- I.** Meat drawer adjustment
- K.** Compartment
- L.** Door tray with bottle holder
- M.** 2 litre door tray with bottle holder
- N.** 0.75 litre door tray
- O.** Shelf separator
- P.** Egg tray
- Q.** Water filter (on some models)
- R.** Multiflow

CONTROL PANEL DESCRIPTION

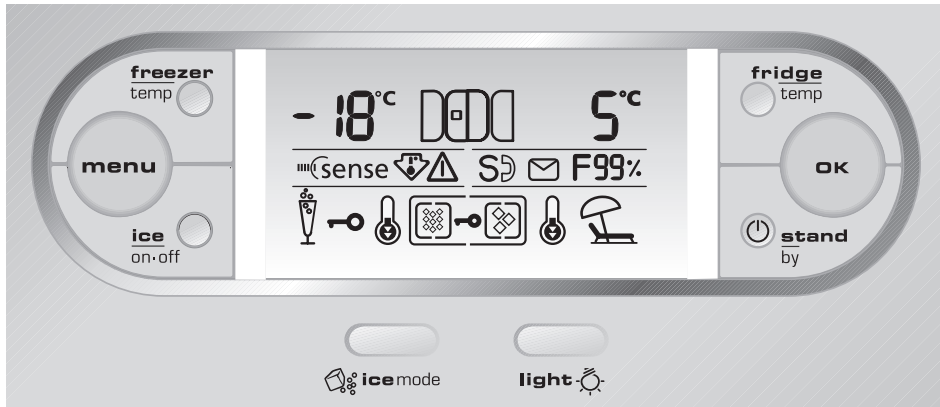

Compartments ON / OFF, menu, selection and confirmation buttons



- 1. Freezer compartment temperature control button
- 2. Refrigerator compartment temperature control button
- 3. Menu button
- 4. Confirmation button
- 5. Ice maker On/Off button
- 6. Appliance On/Off button

Functions and settings symbols

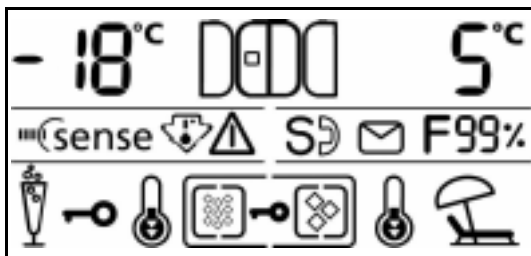

Functions and settings for the refrigerator and freezer compartments

Appliance, alarm and malfunction symbols

Appliance symbols and selection of ice cubes

Functions and settings for the freezer compartment

 Freezer and/or refrigerator compartment door open

 "Party" function ON

 -18°C Freezer compartment temperature setting

Functions and settings for the refrigerator compartment

 Fast freeze function

 5°C Refrigerator compartment temperature setting

 Fast cooling function

 Vacation function

Appliance, alarm and malfunction symbols

 Sixth sense function in operation. The appliance is working to reach optimum food storage conditions

 Control panel locked

 Alarm symbol, generally in association with an acoustic alarm

 Malfunction and After-sales Service symbol

Functions and settings for the ice maker and water filter

 Selection of ice cubes or crushed ice

 F99% Indicates the state of the water filter

HOW TO OPERATE THE FREEZER/ REFRIGERATOR

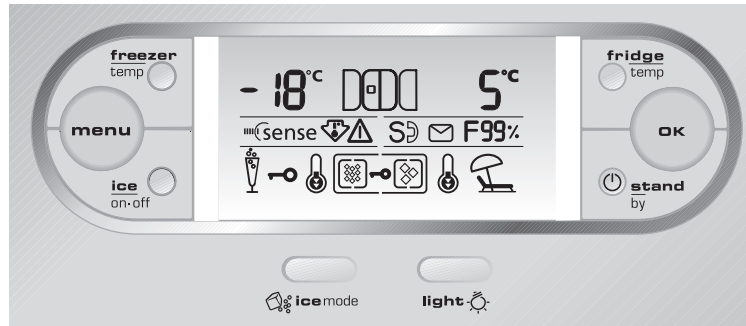

Connect the appliance to the water supply and power supply (see Installation manual).

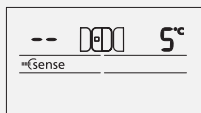

When the appliance is connected to the power supply, the display lights up and all the symbols appear on the display for a few seconds. Hyphens appear on the freezer display and the symbol  flashes, while the refrigerator display shows a temperature of +5°C (factory-set).

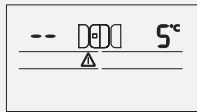

While the appliance is working to reach the factory-set temperature, the alarm led flashes , an acoustic alarm sounds and the freezer display shows flashing hyphens. This indicates that the appliance has not yet reached the optimal temperature for storage of foodstuffs.



Press the  button to disable the acoustic alarm.

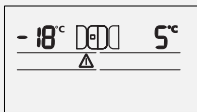

The led  will stop flashing when the freezer compartment reaches a temperature below -12°C, the display will show the temperature -18°C, at which point food can be loaded into the freezer compartment.

After being switched on, the refrigerator needs 2/3 hours to reach the correct temperature to store a typical volume of food in the refrigerator compartment.

IMPORTANT:

- If food is placed in the refrigerator before the appliance has reached a suitable temperature for storing food, it may deteriorate.
 - Turning the refrigerator and freezer controls to a cooler than recommended setting will not cool the compartments any faster.
 - Do not place food near the air vents in the refrigerator compartment.
 - A built-in exterior moisture control continuously guards against moisture build-up on the front edges. Do not be alarmed if these edges sometimes feel warm to the touch.
- The inside light switches on when both doors are opened.

GUIDE TO SELECTING FUNCTIONS

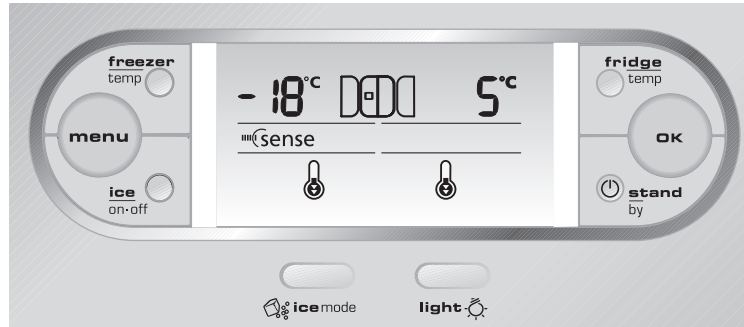

Freezer compartment temperature

Shows the freezer compartment temperature setting.

The set temperature is stored and will automatically be restored even after a power failure or if the appliance is switched off by pressing the standby button.

Freezer compartment temperature selection and control

To change the internal temperature press button **freezer temp** until the desired value is reached. The selected temperature flashes and then becomes fixed within 5 seconds.



Fast freeze

This function must be activated before freezing fresh food. To select the function, keep pressing the menu button until the display shows the fast freeze symbol .

The symbol flashes and the relative door symbol lights up; press ok to confirm.

The function is automatically disabled after 24 hours, or can be manually disabled by repeating the same procedure.

Refrigerator compartment temperature

Shows the refrigerator compartment temperature setting.

The set temperature is stored and will automatically be restored even after a power failure or if the appliance is switched off by pressing the standby button.

Refrigerator compartment temperature selection and control

To change the internal temperature, keep pressing the **fridge temp** button until the desired value is reached. The selected temperature flashes and then becomes fixed within 5 sec.



Fast cooling

This function should be selected before refrigerating fresh food. To select the function, keep pressing the menu button until the display shows the fast cooling symbol .

The symbol flashes and the refrigerator door on the display lights up; press ok to confirm.

The function is automatically disabled after 6 hours, or can be manually disabled by repeating the same procedure.

Note: when selecting the chosen function, the user has 5 seconds to confirm his selection by pressing ok; if he fails to do so within this time, he must start over by pressing the menu button.

Function sense

The 6th Sense function is automatically activated when:

- a large amount of food is loaded into the refrigerator and/or freezer
- the refrigerator and/or freezer door is left open for a long time
- a prolonged power failure takes place, causing the internal temperature of the appliance to increase to values that cannot guarantee safe storage of food.

The symbol flashes for approximately 3 seconds, after which it remains permanently lit until optimal storage conditions have been automatically restored.

GUIDE TO SELECTING FUNCTIONS



Vacation

This function turns off the refrigerator compartment if you are going away for some time. To select the function, keep pressing the menu button until the display shows the vacation symbol . The symbol flashes and the refrigerator compartment display shows no temperature; press ok to confirm. To turn the refrigerator back on, repeat this procedure.

Important: after activating this function, remove all perishable foodstuffs from the refrigerator compartment and leave the door closed, since the refrigerator maintains a suitable temperature to prevent the formation of unpleasant odours.

Party mode

To select the function, keep pressing the menu button until the display shows the party mode symbol . The symbol flashes; press ok to confirm.

Use this function to chill drinks inside the freezer compartment.

When the function is in operation, the symbol is animated. 30 minutes after selection (the time required to chill a 0.75 l bottle without the glass breaking), the symbol flashes, an acoustic alarm sounds and the display lights up: remove the bottle from the freezer compartment and press the ok button to disable the function.

Important: do not leave the bottle inside the freezer compartment longer than the time necessary for chilling.

Control panel lock function

This function prevents anyone from inadvertently changing settings or switching off the appliance.

To lock the control panel, press buttons **freezer temp** and **fridge temp** simultaneously for 3 seconds until the display shows the symbol  an acoustic signal confirms the function has been selected.

To disable the function, follow the same procedure until the symbol  switches off.

Standby

This function deactivates both the refrigerator and freezer compartments.

To enable the standby function, press the button  for 3 seconds, two hyphens appear at the top of the display to indicate that the appliance is on standby.

To restore the previous setting, carry out the same procedure until the previous temperatures appear on display.

When the appliance is on standby the light inside the refrigerator compartment is off. Remember that this operation does not disconnect the appliance from the power supply.

GUIDE TO SELECTING FUNCTIONS

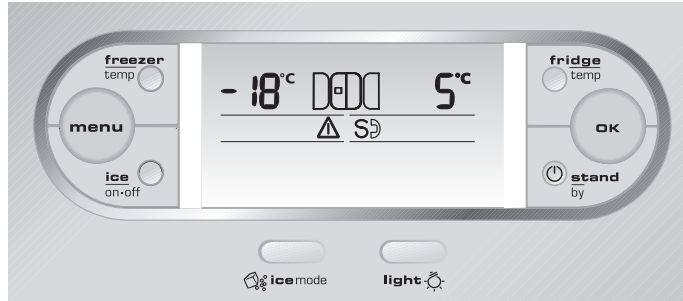

Alarms

In the event of an alarm, the acoustic alarm and indicator lights are activated. The display lights up whenever an alarm situation arises.

Freezer temperature alarm

The acoustic alarm sounds: the alarm symbol flashes and the temperature indicator on the display is replaced by two hyphens.

The alarm is activated when:

- The appliance is connected to the power supply for the first time or after prolonged disuse
- The freezer compartment temperature is too high
- The quantity of foods loaded into the freezer exceeds that indicated on the data plate
- The freezer door has been left open for a long time

Note: in these cases Sense automatically appears on the display

Power failure alarm

The maximum temperature reached during a power failure flashes on the freezer display. The alarm symbol lights up and the acoustic alarm sounds at the same time.

The alarm is activated when:

- a prolonged power failure takes place, causing the internal temperature of the freezer to increase to values that cannot guarantee safe storage of food.

To disable the alarm press ok for at least 3 seconds, after which the pre-set temperature will appear on the display.

Note: check the state of food in both compartments before refreezing or using it.

Operation alarms

In the event of operation alarms, other alarms will also be displayed in the refrigerator or freezer compartment, depending on the malfunction site, (e.g. SF or D etc...) call After-sales Service and specify the alarm code.

Refrigerator/freezer door open alarms

The refrigerator/freezer door symbol (or both) light up and the acoustic alarm sounds.

The alarm is activated when:

- one or both of the doors are left open for more than 2 minutes.

Press ok to mute the acoustic alarm.

If the door is not closed, the acoustic alarm will sound again after two minutes.

Close the door/s and press the ok button.

Note: in these cases Sense automatically appears on the display

USE OF THE ICE DISPENSER (ON SOME MODELS)

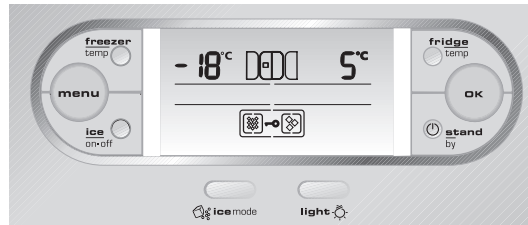

ice on/off Ice maker on/off

This function enables/disables the production of ice.

To switch the ice maker on/off, press the button **ice on/off** for three seconds.

ice mode Ice maker selection

The function is activated when the symbol  is lit up. Press the button **ice mode** to select the desired type of ice desired (cubes or crushed). The symbol will light up.

To dispense ice:

1. Press the button **ice mode** and select the type of ice desired.
2. Press a sturdy glass against the ice dispenser lever. Hold the glass close to the dispenser opening so ice does not fall outside of the glass.
3. You do not need to apply a lot of pressure to the lever in order to activate the ice dispenser. Pressing hard will not make the ice dispenser faster or in greater quantities.
4. To stop dispensing, remove the glass slowly so ice does not fall outside of the glass.
5. Do not use a delicate glass to dispense ice.



Note:

The first few batches of ice cubes may have an off-taste; throw this ice away. Ice is dispensed from the automatic ice maker bucket in the freezer compartment.

When a glass is held against the external lever, the light inside the dispenser switches on, switching off again when the lever is released, and a trapdoor opens between the ice bucket and the dispenser. When the glass is taken away from the dispenser bar, the trapdoor closes.

The dispenser will not operate when the freezer compartment door is open. Large amounts of ice cubes should be taken directly from the bucket, not through the dispenser.

For crushed ice, cubes are crushed before being dispensed. This may cause a slight delay in dispensing crushed ice. Noise from the ice crusher is normal, and pieces of ice may vary in size.

When changing from crushed ice to ice cubes, a small quantity of crushed ice will be dispensed along with the first cubes. After starting the appliance, it generally takes overnight before the first ice cubes are ready.

- If the dispenser does not dispense ice when you press the bar, change the ice selection from ice cubes to crushed ice or vice versa, so as to remove any ice blocks.
- If the dispenser still does not dispense ice, wait two minutes and repeat this operation.
- If there is condensation in the ice/water dispenser area, press the corresponding button (marked **A** in the figure) to activate the anti-condensation device.

USE OF THE AUTOMATIC ICE MAKER (ON SOME MODELS)

Useful hints on the automatic ice maker

If the freezer compartment door is open, make sure the inside flap is not blocked as it serves as lock sensor that shuts off the transfer of ice from the automatic ice maker into the bucket installed in the door.

To remove and replace the ice bucket:

1. Place four fingers in the bucket base opening and rest your thumb on the release button.
 2. Holding the base of the bucket with both hands, press the release button and lift the bucket up and out. It is not necessary to turn the ice maker control to the OFF position. The ice maker will not produce ice without the bucket installed in the door.
- **Normal Ice Production** should produce approximately 7 to 9 batches of ice in a 24-hour period.



To care for the ice storage bucket:

1. Empty the bucket. Use warm water to melt the ice if necessary.
Never use anything sharp to break up the ice in the bucket. This can cause damage to the ice bucket and the dispenser mechanism.
2. Wash the ice bucket with a mild detergent, rinse well and dry thoroughly.
Do not use harsh or abrasive cleaners or solvents.

Note: do not turn the ice maker on until it is connected to the water supply.

- It is normal for ice cubes to be attached by a corner. They will break apart easily.
- The ice maker will not operate until the freezer compartment is cold enough to make ice.
This can take overnight.
- Good water quality is important for good ice quality. Water softener chemicals such as salt can damage the ice maker and lead to poor quality ice.



USE OF THE WATER DISPENSER (ON SOME MODELS)

Dispensing water

To dispense water press a glass against the water dispenser lever and to stop dispensing remove the glass; the light inside the dispenser turns on simultaneously and turns off when the lever is released. Hold the edge of the glass close to the dispenser opening so water does not spill out of the glass.

In addition, wait a few seconds before removing the glass in order to catch the last few drops of water or pieces of ice.

The water tank is located in the refrigerator compartment behind the two lower drawers.

Note:

Pressing hard will not make the water dispenser operate faster or produce greater quantities.

To dispense water:

After the water dispenser has been switched on, throw the first glasses of water away, then the water can be used. Repeat this operation whenever water has not been dispensed for a long time.

You do not need to apply a lot of pressure to the lever in order to activate the dispenser. Hold the edge of the glass close to the dispenser opening. Remove the glass slowly so water does not spill out of the glass. Pressing hard will not make the water dispenser operate faster or produce greater quantities.



WATER FILTER MONITORING AND REPLACEMENT FUNCTION (ON SOME MODELS)

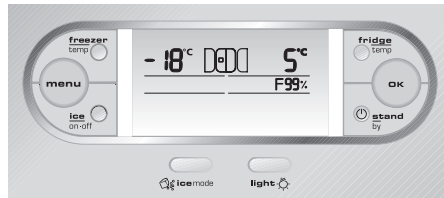

Water filter indicator light function (if present)

The F99% symbol on the display indicates the degree of consumption of the water filter. At the moment of purchase and after filter replacement, the water filter symbol shows the percentage F99%, which will decrease at a rate depending on product use and the natural consumption of the filter charge.

When a new replacement filter needs to be ordered, the F10% symbol on the display flashes and an acoustic signal sounds; press ok to mute.

Important: the filter must only be replaced when the display shows F1%.

At this point the filter cartridge must be replaced.

Note: do not use water that is microbiologically impure or unpurified water of unknown quality upline or downline of the system.

CHANGING A WATER FILTER CARTRIDGE

The water filter is located below the freezer compartment door.

1. Locate the water filter cartridge cap in the front base grille below the freezer compartment door. Rotate the cap counterclockwise to a vertical position and pull the cap and filter cartridge out through the base grille.

NOTE: Since there is water in the cartridge, some spilling may occur.

2. Remove the cartridge cap by sliding it off the end of the old cartridge. The cap will slide to the left or right. DO NOT DISCARD THE CAP.

3. Take the new cartridge out of its packaging and remove the protective cover from the o-rings.

4. Slide the cartridge cap onto the new cartridge as shown.

5. With cartridge cap in the vertical position, push the new filter cartridge into the base grille until it stops. Rotate the cartridge cap clockwise to a horizontal position.

6. RUN WATER THROUGH THE DISPENSER UNTIL THE WATER RUNS CLEAR (about 9-14 litres or 6-7 minutes). This will clean the system and clear air from the lines.

NOTE: as air is cleared from the system, water may spurt out of the dispenser.

Ordering replacement filters

To order more water filter cartridges, please contact your authorized Whirlpool dealer.



GUIDE TO SELECTING FUNCTIONS

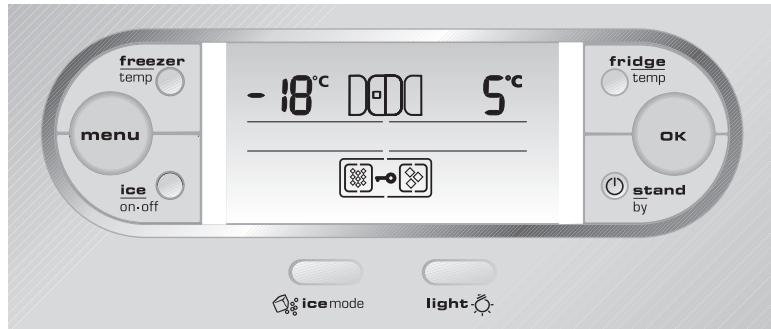

Light

The dispenser area has a night light. The night light can be switched on and off by pressing the button  on the control panel or one of the two dispenser levers (water, ice), allowing the dispenser to be used even in the dark.

Your dispenser can be turned off for easy cleaning or to prevent accidental dispensing by small children and pets. To switch the dispenser off, press button **ice on/off** until the symbols turn off.

The ice maker will automatically switch off when it finishes making ice.

To turn off both the water and ice dispenser, press the light button and the ice selection button simultaneously.

The light will automatically switch off when the control panel Lock function is activated.

Note: The lock feature does not shut off power to the appliance, to the ice maker or to the light. It simply deactivates the dispenser levers.

Ice maker control panel lock

With this function, the ice/water dispenser can be turned off for easy cleaning or to prevent accidental dispensing by children and pets.

To lock the control panel, press button  and  simultaneously for 3 seconds until the symbol  lights up; an acoustic signal confirms the function has been selected.

To disable the function, follow the same procedure until the symbol switches off.

Note: The lock feature does not shut off power to the appliance, to the ice maker or to the light. It simply deactivates the dispenser levers.

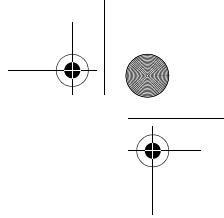

REFRIGERATOR COMPARTMENT AIR DISTRIBUTION SYSTEM

“MULTIFLOW” is a ventilated air-flow system which ensures virtually uniform temperature throughout the refrigerator compartment.

Food can be arranged on any shelf inside the appliance. However, take care not to obstruct the air vents in order to allow air to circulate freely.

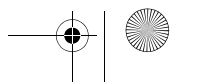
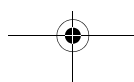
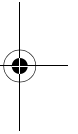
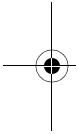

GUIDE TO INTERNAL COMPONENTS

Removal and rearrangement of the refrigerator and freezer shelves

It is possible to position the shelves according to your needs. The glass shelves are strong enough to hold bottles, milk cartons and heavy food; however, please don't bang them down on the shelves.

To remove the shelves: slide the shelf out as far as it comes, then lift it up and take it out.

Removal of the crisper drawer or the meat drawer:

- slide the drawer out as far as it comes;
- with one hand underneath the drawer, lift it up and pull it out;
- the drawer will come out of its runners and can be pulled out further;
- to remove completely, the drawer will need to be rotated: front end up, back end down.

To remove the glass cover of the drawer

- Lift the front of the frame 10 cm, then with your other hand, lift the back of the frame and pull it out.

To put the glass cover of the drawer back

- Insert the back of the frame in the supports on the refrigerator walls and lower it back into place.

Meat drawer temperature control

- The cold air flows into the meat drawer through an opening between the refrigerator and the freezer compartment. In this way the temperature inside the meat drawer is lower than in other parts of the refrigerator. Set the slider for higher or lower airflow.
- If you wish to store vegetables in the meat drawer, move the control all the way to the left to the vegetables setting. This avoids possible frost damage to the vegetables.

Crisper drawer moisture control

- The control may be set to any position between the minimum ● and maximum setting ● .
- This position ● excludes damp air from the drawer for better preservation of fruit and vegetables with peel.
- This position ● keeps damp air inside the drawer for better preservation of leafy vegetables.

Removal of the freezer compartment baskets

- Slide the basket out as far as it comes.
- Lift the front up to release the basket from the retainer.
- Pull out the basket completely.

Removal of the ice storage bucket

- Press the button located on the bottom side of the ice storage bucket.
- Lift the bucket up and out of the base and empty it.
- Reinstall the bucket in the freezer compartment inner door.



GUIDE TO STORAGE AND THAWING OF FOOD

The freezer compartment, marked with the symbol , is used for storing frozen food and freezing fresh or cooked food. It can also be used for making ice cubes. The inner door of the freezer, marked with the symbol **, is especially suitable for storing ice cream or frozen food with a short storage time.

The maximum quantity of food which can be frozen in a 24 hour period, at an ambient temperature of 25°C, is stated on the rating plate, inside the refrigerator.

For more efficient freezing, press the **menu** button and pre-freeze by pressing the fast freeze  button.

After 24 hours place the food to be frozen on the top shelf of the freezer compartment. Freezing of fresh food and automatic ice making cannot be carried out at the same time. Therefore do not forget to stop the automatic ice maker by pressing the **ice on/off** button.

See the operating instructions in chapter "Automatic ice maker".

PREPARATION OF FRESH FOOD FOR FREEZING

It is important to wrap food so that no water, moisture, or vapour may penetrate; this avoids the transfer of odour or flavour throughout the refrigerator and allows better storage of frozen food. We recommend the use of plastic containers with tight fitting lids, aluminium trays, aluminium foil, plastic film, and waterproof plastic wrappings.

SEALING

When sealing the food in bags, squeeze out the air (liquids need head space to allow for expansion). Seal the top of the bag with a fastener. Place labels on the inside of clear freezer bags; use self-adhesive labels on the outside of opaque ones.

DEFROSTING

Here are some helpful hints.

Raw vegetables: do not thaw, put straight into boiling water and cook as usual.

Meat (large cuts): thaw in the refrigerator compartment without unwrapping. Before cooking, leave at room temperature for a couple of hours.

Meat (small cuts): thaw at room temperature or cook directly.

Fish: thaw in the refrigerator compartment without unwrapping or cook before fully thawed.

In the event of a power failure, the freezer compartment maintains the appropriate storage temperature for approximately 12 hours; during this time, we suggest you leave the door of the compartment closed. Do not refreeze partially thawed food.

Previously cooked food: reheat in the oven without removing it from its aluminium container.

Fruit: thaw in the refrigerator compartment.

NOTE: Never store warm food in the freezer.

Allow hot foods to cool to room temperature for 30 minutes, then wrap and freeze. Cooling hot foods before freezing saves energy and prolongs the life of the appliance.

FOOD STORAGE CHART

Storage time will vary according to the quality of the food, the type of packaging or wrap used (moisture and vapour proof), and the storage temperature (which should be -18°C).

FOODSTUFF AND STORAGE TIME

Fruit	
Concentrated fruit juice	12 months
Fruit (in general)	8 to 12 months
Citrus fruit and fresh fruit juice	4 to 6 months
Vegetables	
Commercially frozen	8 months
Home frozen	8 to 12 months
Meat	
Sausages	4 weeks or less
Hamburgers	1 month
Beef, veal, lamb	2 to 3 months
Roasts	
Beef	6 to 12 months
Lamb and veal	6 to 12 months
Pork	4 to 8 months
Fresh sausages	1 to 2 months
Steaks and chops	
Beef	8 to 12 months
Lamb, veal, pork	2 to 4 months
Fish	
Cod, flounder, sole	6 months
Salmon	2 to 3 months
Mackerel, perch	2 to 3 months
Dressed fish (purchased)	3 months
Clams, oysters	3 to 4 months
Boiled fish, crabs	3 to 4 months
Raw prawns	12 months
Poultry	
Chicken or turkey (whole or parts)	12 months
Duck and goose	6 months
Offal	2 to 3 months
Poultry cooked in a sauce	6 months
Sliced meat (no sauce)	1 month
Stews	
Meat, poultry, and fish	2 to 3 months

DAIRY PRODUCTS

Butter	6 to 9 months
Margarine	12 months
Cheese	
Camembert, mozzarella, spreading cheese	3 months
Cream cheeses	do not freeze
Brie, Emmenthal, Swiss cheese, etc. (freezing may affect cheese texture)	6 to 8 months

Ice cream, fruit juices, milk	12 months
-------------------------------	-----------

Eggs (Add sugar or salt to yolks or whole beaten eggs)	
Whole (beaten), whites, yolks	12 months

PASTRY AND BREAD

Leavened bread and rolls	3 months
Unbaked bread	1 month
Croissants	3 months
Cakes (not iced)	2 to 4 months
Cakes (iced) and biscuits	6 to 12 months
Fruit pies	12 months
Biscuit pastry	3 months
Pie pastry	4 to 6 months

COMMON ICE MAKER PROBLEMS

PROBLEM	CAUSE	SOLUTION
The dispenser does not work.	The freezer compartment door is open.	Close the freezer compartment door.
	The ice bucket is not properly installed.	Make sure that the bucket is pushed all the way in.
The ice dispenser stops working.	The dispenser has not been used for extended periods, causing the ice cubes to melt together.	Shake the bucket occasionally to keep cubes separate and to increase storage capacity. Throw old ice cubes away and make a new supply.
	The ice dispenser bar has been held in for too long.	Wait about 3 minutes for the dispenser motor to reset. Large amounts of ice should be taken from the bucket, not through the dispenser.
Off-taste or odour in ice.	Ice absorbs airborne odours.	New ice should be made. Throw old ice away and make new supply.
	Water quality.	Store excess ice in a covered container. Water containing minerals may require a filter.
	Food not properly wrapped.	Wrap food properly.
	The ice bucket and the freezer compartment may need cleaning.	Clean the ice bucket and the freezer. Follow instructions for a proper water supply to ice maker.
	Plumbing connections to ice maker.	The first few batches of ice from a new ice maker may have an off-taste. Throw the first few batches away and make a new supply.

NOTE: Only use cubes from the ice maker.

MAINTENANCE AND CLEANING

Before any cleaning or maintenance operation, unplug the appliance from the mains or disconnect the electrical power supply.

Periodically clean the refrigerator and freezer compartments with a sponge dampened in a solution of lukewarm water and vinegar. Rinse and dry. Never use detergents or abrasives. Never clean refrigerator parts with flammable fluids. The fumes can create a fire hazard or explosion.

Clean the outside with a sponge dampened in lukewarm water.

Dry with a soft cloth.

- Do not use steam cleaners;
- Clean the condenser and seal.

NOTE: The refrigeration system tubes are located near the defrost pan and can become hot. Periodically clean them with a vacuum cleaner.

Always disconnect the refrigerator from the power supply before replacing any light bulbs.

Removal of the refrigerator light cover:

- Loosen the screw that secures the light cover;
- pull downwards and slide the cover towards the rear of the refrigerator;
- replace the bulb with one of the same type available only from our After-sales Service Centre;
- put the light cover back into place, repeat the above steps in reverse order.

How to replace the freezer upper compartment bulb:

- Remove the light shield by squeezing the side sections;
- remove the bulb and replace it with one of the same type available only from our After-sales Service Centres or authorized dealers;
- put the light shield back in place, repeat the above steps in reverse order.

How to replace the lower bulb in the refrigerator and freezer compartments (on some models):

- remove the light shield, gripping it by the upper middle part;
- pull the front and, at the same time, slightly turn the shield to one side;
- remove the bulb and replace it with one of the same type available only from our After-sales Service Centres or authorized dealers.

To put the light shield back into place:

- Grip the upper middle part of the light shield;
- insert the tabs of one side of the shield into the grooves;
- gently bend the light shield in the centre to insert the tabs on the other side.

How to replace the dispenser bulb (on some models):

- Grip hold of the bulb in the dispenser recess;
- remove the bulb and replace it with one of the same type available only at our After-sales Service Centres or authorized dealers.

VACATION

Short vacation

There is no need to disconnect the refrigerator from the power supply if you will be away for less than three weeks. Use up perishable food, freeze other food. If your appliance has an automatic ice maker:

1. Turn it off;
2. shut off the water supply to the ice maker;
3. empty the ice bucket.

Long vacation

Remove all the food if you are going away for three weeks or more. If your appliance has an automatic ice maker, turn off the water supply to the ice maker at least a day before and as soon as the last batch of ice cubes is produced, turn off the ice maker. **EMPTY THE ICE BUCKET.** Unplug the refrigerator and clean it, rinse and dry.

Fix some wooden or plastic wedges to the upper part of both doors with adhesive tape and leave the doors open enough for air to circulate inside both compartments. This will prevent odour and mould from setting in.

Moving

- Take out all removable parts, wrap them well, and fix them together with adhesive tape so that they do not bang together or get lost.
- Tighten the front levelling screws.
- Close and fix both doors with adhesive tape and, again using adhesive tape, fix the power cable to the appliance.

Power failure

In the event of a power failure, call the local office of your electricity supply company and ask how long it is going to last.

1. For power failures lasting up to 24 hours, **keep both doors of the appliance closed.** This will allow the stored food to stay cold as long as possible.
2. Should the power failure last more than 24 hours, remove all frozen food and put it in a freezer with a key lock. If this type of freezer is not available and, likewise, no artificial ice packs are available, try to use up the food which is more easily perishable.
3. Bear in mind that a full freezer compartment will stay cold longer than a partially filled one.
4. Empty the ice bucket.

Furthermore, a freezer full of frozen meat will stay cold longer than a freezer filled with pre-cooked food.

If ice crystals are still visible on the food, it may be frozen again, although flavour and aroma may be affected.

If food is found to be in a poor condition, it is best to throw it away.

TROUBLESHOOTING GUIDE/AFTER-SALES SERVICE

When you hear these noises

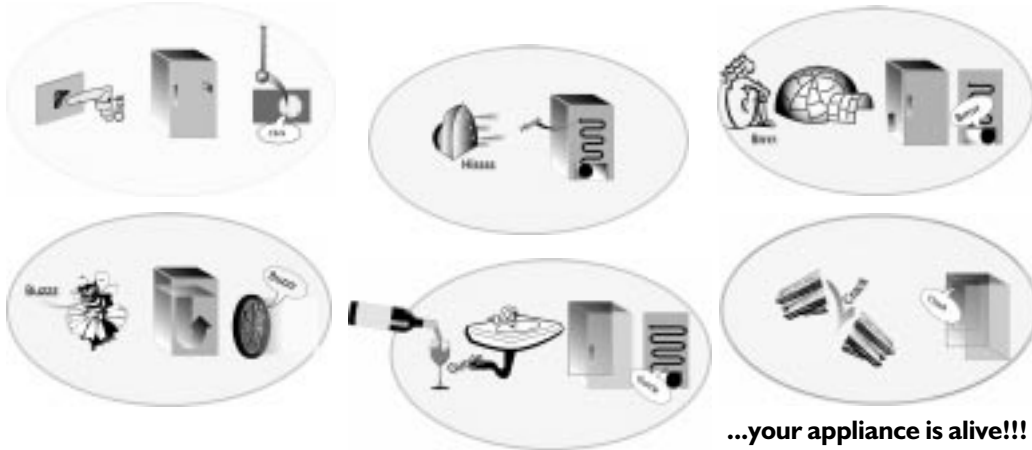

Before calling After-sales Service....

Performance problems often result from simple things you can find and solve yourself without tools of any kind.

The appliance is not working

- Is the power plug plugged into a live socket with the proper voltage?
- Have you checked your home's fuses?
- **Ice maker noises**

Since your appliance has an ice maker, you may hear buzzing (from the water valve), trickling water and the clatter of the ice falling into the bucket.

If your ice maker does not work:

- Has the freezer had enough time to become cold? With a new refrigerator this may take overnight.
- Is the ice maker ON/OFF button set to ON ?
- Is the water turned on? Is water getting to the ice maker?
- Is there a water filter installed on the refrigerator? This filter may be clogged or installed incorrectly. First, check the filter installation instructions to ensure that the filter was installed correctly and is not clogged. If installation or clogging is not a problem, call a qualified technician.

If there is water in the defrost pan:

- This is normal in hot, damp weather. The pan can even be half full. Make sure the refrigerator is level so that the water does not overflow.

If the edges of the refrigerator cabinet, which come in contact with the door seal, are warm to the touch:

- This is normal in hot weather and when the compressor is running.

If the light does not work:

- Have you checked your home's fuses?
- Is the power plug plugged into a live socket with the proper voltage?
- Has the light bulb burnt out?

In the case of burnt-out bulbs:

1. Always unplug the appliance from the mains.
2. See chapter "Maintenance and Cleaning".

If the motor seems to run too much:

- Is the condenser free of dust and fluff?
- Are the doors properly closed?
- Are the door seals properly fitted?
- On hot days or if the room is warm, the motor naturally runs longer.

If the appliance door has been left open for a while or if large amounts of food have been stored, the motor will run longer in order to cool down the interior of the appliance.

Remember

Motor running time depends on different things: number of door openings, amount of food stored, temperature of the room, setting of the temperature controls.

If, after performing the above checks, your appliance still does not work properly, contact the After-sales Service, explain the problem, specifying the model and appliance service number (stated on the data plate).

If the refrigerator temperature is too high

- Are the refrigerator controls correctly set?
- Has a large amount of food been added to the refrigerator or freezer?
- Check that the doors are not opened too often.
- Check that the doors close properly.
- Make sure that air flow vents inside the compartment are not blocked, as this prevents the circulation of cold air.

If there is moisture build-up

- Make sure that air flow vents inside the compartment are not blocked, as this prevents the circulation of air.
- Make sure that the food is properly packaged. Dry any dampness on food containers before placing them in the refrigerator.
- Check that the doors are not opened too often. When the door is opened, humidity from the room air enters the refrigerator. The more often the door is opened, the faster humidity builds up, especially when the room itself is very humid.
- If the room is very humid, it is normal for moisture to build up inside the refrigerator.
- It is normal for droplets of water to form on the back wall after the automatic defrost cycle.

If the doors do not open and close properly

- Check that food packages are not blocking the door.
- Check that the pans, shelves, drawers or the ice maker are not out of position.
- Check that the door seals are not dirty or sticky.
- Ensure the appliance is level.

Filter state symbol	Percentage %	Litres	Time (days)	Degree of wear of filter
F99	100	0 - 150	0 - 27	Low (Water filter in good condition)
F90	90	150 - 300	27 - 54	Low (Water filter in good condition)
F80	80	300 - 450	54 - 81	Low (Water filter in good condition)
F70	70	450 - 600	81 - 108	Low (Water filter in good condition)
F60	60	600 - 750	108 - 135	Low (Water filter in good condition)
F50	50	750 - 900	135 - 162	Low (Water filter in good condition)
F40	40	900 - 1050	162 - 189	Low (Water filter in good condition)
F30	30	1050 - 1200	189 - 216	Low (Water filter in good condition)
F20	20	1200 - 1350	216 - 243	Low (Water filter in good condition)
F10	10	1350 - 1365	243 - 246	Average (Order a new water filter)
F9	9	1365 - 1380	246 - 249	Average (Order a new water filter)
F8	8	1380 - 1470	249 - 251	Average (Order a new water filter)
F7	7	1470 - 1410	251 - 254	Average (Order a new water filter)
F6	6	1410 - 1425	254 - 257	Average (Order a new water filter)
F5	5	1425 - 1440	257 - 260	Average (Order a new water filter)
F4	4	1440 - 1455	260 - 262	Average (Order a new water filter)
F3	3	1455 - 1470	262 - 265	Average (Order a new water filter)
F2	2	1470 - 1500	265 - 270	Average (Order a new water filter)
F1	1	> 1500	> 270	High (Change the water filter)

Values given in the table are for guidance only.

AFTER-SALES SERVICE

Before contacting After-Sales Service:

1. See if you can solve the problem yourself (see "TROUBLESHOOTING GUIDE/AFTER-SALES SERVICE").
2. Switch the appliance on again to see if the problem has been solved. If it has not, disconnect the appliance from the power supply and wait for about an hour before switching on again.
3. If the problem persists after this course of action, contact After-sales Service.

Specify:

- the nature of the problem,
- the model,
- the Service number (the number after the word SERVICE on the data plate on the inside of the appliance),
- your full address,
- your telephone number and area code.

SERVICE 0000 000 00000



Note:

The direction of door opening can be changed. If this operation is performed by After-sales Service it is not covered by the warranty.

ELECTRICAL CONNECTION

For Great Britain only

Warning - this appliance must be earthed

Fuse replacement

If the mains lead of this appliance is fitted with a BS 1363A 13amp fused plug, to change a fuse in this type of plug use an A.S.T.A. approved fuse to BS 1362 type and proceed as follows:

1. Remove the fuse cover (A) and fuse (B).
2. Fit replacement 13A fuse into fuse cover.
3. Refit both into plug.

Important:

The fuse cover must be refitted when changing a fuse and if the fuse cover is lost the plug must not be used until a correct replacement is fitted.

Correct replacement are identified by the colour insert or the colour embossed in words on the base of the plug.

Replacement fuse covers are available from your local electrical store.

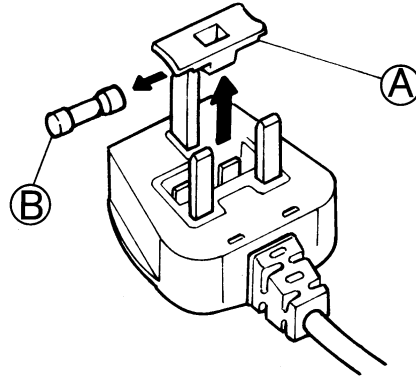

For the Republic of Ireland only

The information given in respect of Great Britain will frequently apply, but a third type of plug and socket is also used, the 2-pin, side earth type.

Socket outlet / plug (valid for both countries)

If the fitted plug is not suitable for your socket outlet, Please contact Whirlpool Service for further instruction. Please do not attempt to change plug yourself. This procedure needs to be carried out by a qualified Whirlpool technician in compliance with the manufactures instructions and current standard safety regulations.