

DIE 2B19 A

12NC: 869991586400

GTIN (EAN) code: 8050147586402

Indesit
Life proof.

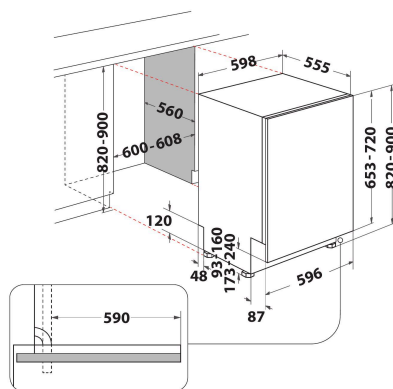

MAIN FEATURES

Construction type	Built-in
Installation type	Full-integrated
Type of control	Electronic
Type of control settings	Digit
Removable work top	No
Main colour of product	White
Electrical connection rating (W)	1900
Current (A)	10
Voltage (V)	220-230
Frequency (Hz)	50
Length of Electrical Supply Cord (cm)	130
Plug type	Schuko
Length inlet hose (cm)	155
Length outlet hose (cm)	150
Adjustable feet	Yes - all
Height of the product	820
Width of the product	598
Depth of the product	555
Minimum niche height	0
Maximum niche height	0
Minimum niche width	0
Maximum niche width	0
Niche depth	560
Net weight (kg)	32.1
Gross weight (kg)	33.9

TECHNICAL FEATURES

Automatic programmes	No
Maximum temperature for water intake (°C)	0
Start delay options	No delay
Start delay time max. (h)	0
Progress indicator	-
Digital countdown indicator	No
Salt light indicator	Yes
Rinse aid light indicator	No
Safety device	Yes
Adjustable upper basket	Yes
Largest loadable dish upper basket (cm)	0
Largest loadable dish lower basket (cm)	0
Maximum number of place settings (EU 2017/1369)	14
Column installation	No

ENERGY LABEL

Energy Efficiency Class (Regulation (EU) 2017/1369)	F
Energy Consumption for 100 cycles Eco Programme (EU 2017/1369)	105
Power consumption in standby mode (Psm) (EU 2017/1369)	0,50
Power consumption in off-mode (Po) (EU 2017/1369)	0,00
The water consumption of the eco programme in liters per cycle (EU 2017/1369)	12,0
Airborne acoustical noise emissions (EU 2017/1369)	49
Airborne acoustical noise emission class (EU 2017/1369)	C
Programme duration in HMM (EU 2017/1369)	3:20