

DIE 2B19 A

12NC: 869991586400

GTIN (EAN) code: 8050147586402

Indesit
Life proof.

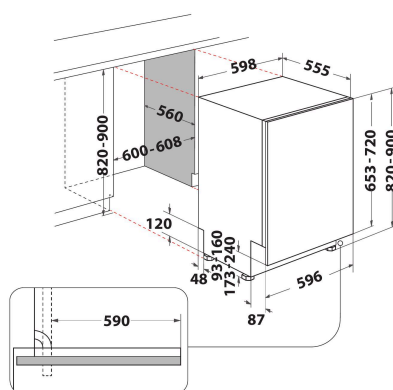

MAIN FEATURES

Construction type	Ugradbeni
Installation type	Potpuno integrirana
Type of control	Electronic
Type of control settings	Digit
Removable work top	Ne
Main colour of product	White
Electrical connection rating (W)	1900
Current (A)	10
Voltage (V)	220-230
Frequency (Hz)	50
Length of Electrical Supply Cord (cm)	130
Plug type	Schuko
Length inlet hose (cm)	155
Length outlet hose (cm)	150
Adjustable feet	Yes - all
Height of the product	820
Width of the product	598
Depth of the product	555
Minimum niche height	0
Maximum niche height	0
Minimum niche width	0
Maximum niche width	0
Niche depth	560
Net weight (kg)	32.1
Gross weight (kg)	33.9

TECHNICAL FEATURES

Automatic programmes	Ne
Maximum temperature for water intake (°C)	0
Start delay options	No delay
Start delay time max. (h)	0
Progress indicator	-
Digital countdown indicator	Ne
Salt light indicator	Yes
Rinse aid light indicator	Ne
Safety device	Yes
Adjustable upper basket	Yes
Largest loadable dish upper basket (cm)	0
Largest loadable dish lower basket (cm)	0
Maximum number of place settings (EU 2017/1369)	14
Column installation	Ne

ENERGY LABEL

Energy Efficiency Class (Regulation (EU) 2017/1369)	F
Energy Consumption for 100 cycles Eco Programme (EU 2017/1369)	105
Power consumption in standby mode (Psm) (EU 2017/1369)	0,50
Power consumption in off-mode (Po) (EU 2017/1369)	0,00
The water consumption of the eco programme in liters per cycle (EU 2017/1369)	12,0
Airborne acoustical noise emissions (EU 2017/1369)	49
Airborne acoustical noise emission class (EU 2017/1369)	C
Programme duration in HMM (EU 2017/1369)	3:20