

DAILY REFERENCE GUIDE



THANK YOU FOR PURCHASING AN INDESIT PRODUCT

To receive more comprehensive help and support, please register your product at www.indesit.com/register



You can download the Safety Instructions and the Use and Care Guide by visiting our website docs.indesit.eu and following the instructions on the back of this booklet.



Before using the appliance carefully read the Health and Safety guide.

PRODUCT DESCRIPTION

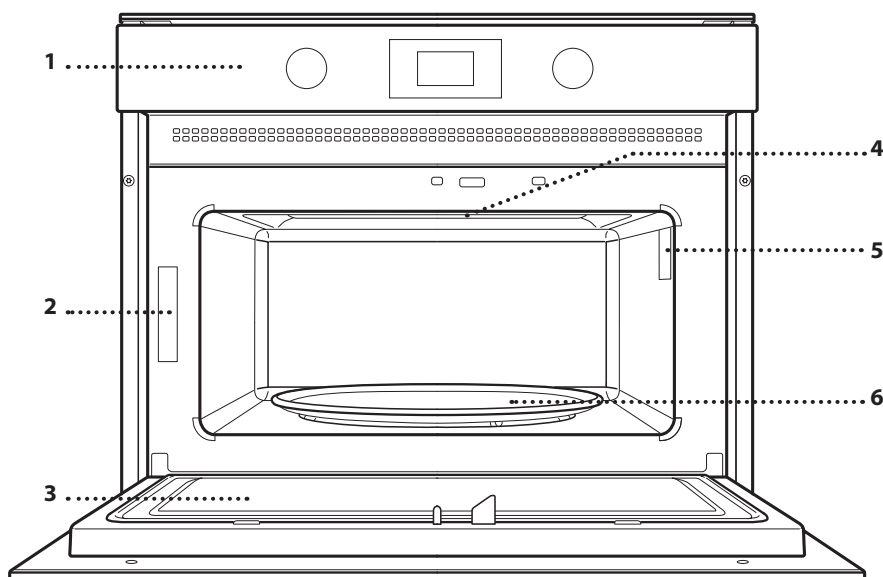

1. Control panel
2. Identification plate (do not remove)
3. Door
4. Upper heating element/grill
5. Light
6. Turntable

CONTROL PANEL

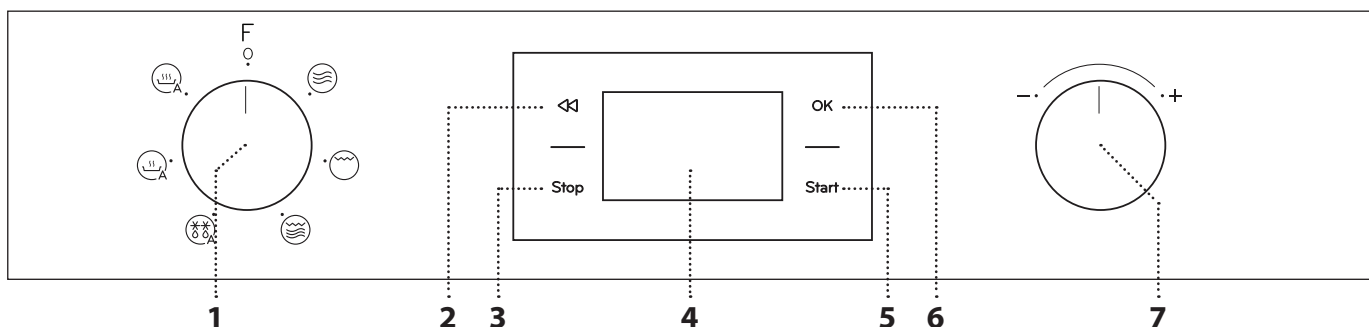

1. SELECTION KNOB

For switching the oven on by selecting a function. Turn to the **O** position to switch the oven off.

2. BACK

For returning to the previous settings menu.

3. STOP

For interrupting an active function at any time. Press twice to stop the function and put the oven on stand-by.

4. DISPLAY

5. START

For starting functions and confirming settings. When the oven is switched off, it activates the microwave function.

6. CONFIRM

For confirming a function selection or a set value.

7. ADJUSTMENT KNOB

For scrolling through the menus and applying or changing settings.

GLASS TURNTABLE

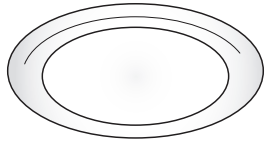

Placed on its support, the glass turntable can be used with all cooking methods. The turntable must always be used as a base for other containers or accessories.

TURNTABLE SUPPORT

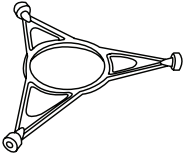

Only use the support for the glass turntable. Do not rest other accessories on the support.

WIRE RACK

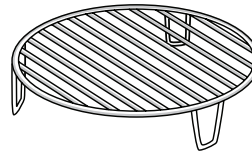

This allows you to place food closer to the grill, for perfectly browning your dish. Place the wire shelf on the turntable.

COVER (IF PRESENT)

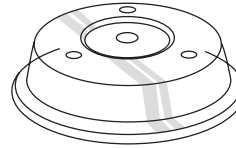

Useful for covering containers during microwave cooking and heating. The cover reduces splashes, keeps foods moist and can also be used to create two cooking levels.

It is not suitable for use with any of the grill functions.

The number and type of accessories may vary according to which model is purchased. Other accessories that are not supplied can be purchased separately from the After-sales Service.

There are a number of accessories available on the market. Before you buy, ensure they are suitable for microwave use and resistant to oven temperatures.

Metallic containers for food or drink should never be used during microwave cooking.

Always ensure that foods and accessories do not come into contact with the inside walls of the oven.

Always ensure that the turntable is able to turn freely before starting the oven. Take care not to unseat the turntable whilst inserting or removing other accessories.

FUNCTIONS



Download the Use and Care Guide from
docs.indesit.eu for more information



MICROWAVE

For quickly cooking and reheating food or drinks.

POWER	RECOMMENDED FOR
1000 W	Quickly reheating drinks or other foods with a high water content
800 W	Cooking vegetables
650 W	Cooking meat and fish
500 W	Cooking meaty sauces, or sauces containing cheese or egg. Finishing off meat pies or pasta bakes
350 W	Slow, gently cooking. Perfect for melting butter or chocolate
160 W	Defrosting frozen foods or softening butter and cheese
90 W	Softening ice cream



GRILL

For browning, grilling and gratins. We recommend turning the food during cooking. For best results, preheat the grill for 3-5 minutes.

Recommended accessories: **Wire rack**



GRILL + MW

For quickly cooking and gratinating dishes, combining the microwave and grill functions.

Recommended accessories: **Wire rack**



AUTO DEFROST *

For quickly defrosting various different types of food simply by specifying their weight. Food should be placed directly on the glass turntable. Turn the food when prompted.

CATEGORY	FOOD	WEIGHT
1*	MEAT (mince, cutlets, steaks, roasting joints)	100 g - 2 kg
2*	POULTRY (whole chicken, pieces, fillets)	100 g - 2.5 kg
3*	FISH (whole, steaks, fillets)	100 g - 1.5 kg
4*	VEGETABLES (mixed vegetables, peas, broccoli, etc.)	100 g - 1.5 kg
5*	BREAD (loaves, buns, rolls)	100 g - 1 kg



AUTO REHEAT *

For reheating ready-made food that is either frozen or at room temperature. Place food on a microwave-safe and heatproof dinner plate or dish.

CATEGORY	FOOD	WEIGHT
1	DINNER PLATE	250 - 500 g
2*	FROZEN PORTION	250 - 500 g
3*	FROZEN LASAGNA	250 - 500 g
4	SOUPS	200 - 800 g
5	BEVERAGES	100 - 500 g



AUTO COOK *

For cooking foods quickly, achieving optimal results. Place food on a microwave-safe and heatproof dinner plate or dish.

CATEGORY	FOOD	WEIGHT
1	BAKED POTATOES (Turn when prompted)	200 g - 1 kg
2	FRESH VEGETABLES (Cut into pieces of equal size and add 2 to 4 tablespoons of water. Cover)	200 - 800 g
3*	FROZEN VEGETABLES (Turn when prompted. Cover)	200 - 800 g
4	CANNED VEGETABLES	200 - 600 g
5	POPCORN	100 g

* With the automatic functions, simply select the type and weight or the quantity of the food items to obtain the best results. The oven will automatically calculate the optimum settings and continue to change them as cooking progresses. Turn or stir the food when prompted.

FIRST TIME USE

• SET THE TIME

You will need to set the time when you switch on the appliance for the first time: The two digits for the hour will flash on the display.



Turn the *adjustment knob* to set the correct hour and press **OK** to confirm. The two digits for the minutes will start flashing. Turn the *adjustment knob* to set the correct hour and press **OK** to confirm.

Please note: to change the time at a later point, press and hold **Stop** for at least 3 seconds while the oven is off and repeat the steps above. You may need to set the time again following lengthy power outages.

DAILY USE

1. SELECT A FUNCTION

When the oven is off, only the time is shown on the display. Turn the *selection knob* to select one of the available functions.



2. SET A FUNCTION

. MANUAL FUNCTIONS

After having selected the function you require, you can change its settings. The display will show the settings that can be changed in sequence.

MICROWAVE POWER / TEMPERATURE



When the **W** icon flashes on the display, turn the *adjustment knob* to adjust the power setting and then press **OK** to confirm and continue to alter the settings that follow (if possible).

In the same way the **°C** icon flashes on the display, turn the *adjustment knob* to adjust the temperature setting and then press **OK** to confirm and continue to alter the settings that follow.

Please note: once the function has been activated, the power can be changed by pressing **◀** two times to access the power settings menu, then turning the *adjustment knob* to change the setting.

DURATION



When the  icon flashes on the display, turn the *adjustment knob* to set the desired duration. Once the displayed cooking time corresponds with what you desire, press **Start** to confirm and start the function.

Please note: During cooking, you can adjust the cooking time by turning the *adjustment knob*; each time you press **Start** the cooking time increases by 30 seconds.

. AUTOMATIC FUNCTIONS / AUTO DEFROST

CATEGORIES

Once you have chosen one of the automatic functions, you will need to select a category for the food you are cooking.



When the  icon flashes on the display, turn the *adjustment knob* to select the digit that corresponds to the desired category, then press **OK** to confirm.

WEIGHT

To achieve the best results, the automatic functions require you to enter the weight of the food, selecting from amongst the default settings: the oven will calculate the ideal length of time for the function to run for each category of food.



When the default setting appears on the display and the **g** icon flashes, turn the *adjustment knob* to enter the weight, then press **Start** to confirm and start the function.

3. ACTIVATE THE FUNCTION

Once you have applied the settings you require, press **Start** to activate the function.

Every time the **Start** button is pressed again, the cooking time will be increased by a further 30 seconds (only for manual functions).

Please note: You can press **Stop** twice at any time to stop the function that is currently active.

. RAPID START

When the oven is switched off, it is possible to press **Start** to activate cooking with the microwave function set at full power (1000 W) for 30 seconds.

. SAFETY LOCK

This function is automatically activated to prevent the oven from being switched on accidentally.



Open and close the door, then press **Start** to start the function.

4. PAUSE

For pausing an active function, for example to stir or turn the food, simply open the door.

To start it up again, close the door and press **Start**.

It is also possible to temporarily pause cooking by pressing **Stop**. To resume the cooking process, close the door and press **Start**.

AUTOMATIC PAUSE (STIR OR TURN THE FOOD)

Certain functions will pause to allow you to turn or stir the food.



When the oven pauses the cooking and "Turn food" or "Stir Food" appear on the display, open the door to turn or stir the food, then close the door and press **Start** to start cooking again.

Please note: after 2 minutes, even if the food has not been turned or stirred, the function will start again automatically.

5. END OF COOKING

An audible signal will sound and "End" will appear on the display to indicate that a cooking function is complete.



For some functions, it is possible to delay cooking while maintaining previously established settings: turn the adjustment knob to set a new cooking time, then press **Start**.

. TIMER

When the oven is switched off, the display can be used as a timer. The timer does not activate any of the cooking cycles.

To activate the function and set the cooking time you require, turn the *adjustment knob*.

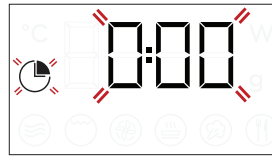































Press **OK** to activate the timer. An audible signal will sound and the display will indicate once the timer has finished counting down the selected time. To make a change to the timer once it has been activated, turn the *adjustment knob*, then press **OK** to confirm.





To interrupt it or return to the current time display, turn the *adjustment knob* until 0:00 is on the display and press **OK**.

Please note: Once the timer has been activated, you can activate a function as well: The timer will continue to count down the selected time automatically without having any effect on the function. To go back to viewing the timer, wait for the function to finish or stop the oven function by pressing **Stop**.

COOKING TABLE

FOOD	FUNCTION	POWER (W)	DURATION (MIN)	ACCESSORIES
Ready-made meals (250 - 500 g)		800	4 - 7	-
Lasagna/pasta bake		350 - 500	15 - 25	 
Frozen lasagna (500 - 700 g)		500 - 800	14 - 20	-
Meat (chops, steaks)		500	10 - 15	 
Poultry (whole, 800 g - 1.5 kg)		350 - 500	30 - 45 *	 
Chicken fillets or pieces		350 - 500	10 - 17	 
Roasts (800 g - 1.2 kg)		350 - 500	25 - 40 *	 
Sausages/kebabs		-	20 - 40 *	
Fish (slices or fillets)		160 - 350	15 - 20 *	 
Whole fish (800 g - 1.2 kg)		160 - 350	20 - 30 *	 
Baked potatoes (600 g - 1 kg)		350 - 500	30 - 50 *	 
Baked apples		160 - 350	15 - 25	 

 www.docs.indesit.eu Download the Use and Care Guide from **docs.indesit.eu** for the table of tested recipes, compiled for the certification authorities in accordance with the standards IEC 60705.

FUNCTIONS	Microwaves 	Grill 	Grill + Microwaves 
ACCESSORIES	Heatproof plate/container suitable for use in microwaves 		Wire rack 

CLEANING

Make sure that the appliance has cooled down before carrying out any maintenance or cleaning.
Do not use steam cleaners.

Do not use wire wool, abrasive scourers or abrasive/corrosive cleaning agents, as these could damage the surfaces of the appliance.

INTERIOR AND EXTERIOR SURFACES

- Clean the surfaces with a damp microfibre cloth. If they are very dirty, add a few drops of pH-neutral detergent. Finish off with a dry cloth.
- Clean the glass in the door with a suitable liquid detergent.
- At regular intervals, or in case of spills, remove the turntable and its support to clean the bottom of the oven, removing all food residue.
- The grill does not need to be cleaned as the intense heat burns away any dirt. Use this function on a regular basis.

ACCESSORIES

All accessories are dishwasher safe.

TROUBLESHOOTING

Problem	Possible cause	Solution
The oven is not working.	Power cut. Disconnection from the mains.	Check for the presence of mains electrical power and whether the oven is connected to the electricity supply. Turn off the oven and restart it to see if the fault persists.
The oven makes noises, even when it is switched off.	Cooling fan active.	Open the door or press Stop
The display shows the letter "F" followed by a number.	Software fault.	Contact your nearest Client After-sales Service Centre and state the number following the letter "F".

PRODUCT FICHE

 [www](http://www.docs.indesit.eu) The product fiche with energy data of this appliance can be downloaded from our website docs.indesit.eu

HOW TO OBTAIN THE USE AND CARE GUIDE

>  [www](http://www.docs.indesit.eu) Download the Use and Care guide from our website docs.indesit.eu (you can use this QR code), specifying the product's commercial code.



> Alternatively, contact our Client After-sales Service.

CONTACTING OUR AFTER-SALES SERVICE

You can find our contact details in the warranty manual. When contacting our Client After-sales Service, please state the codes provided on your product's identification plate.

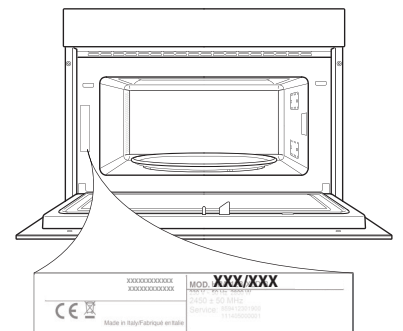

400011022919

Printed in Italy