

Whirlpool



EN













Health & Safety, Use and Care and Installation guide



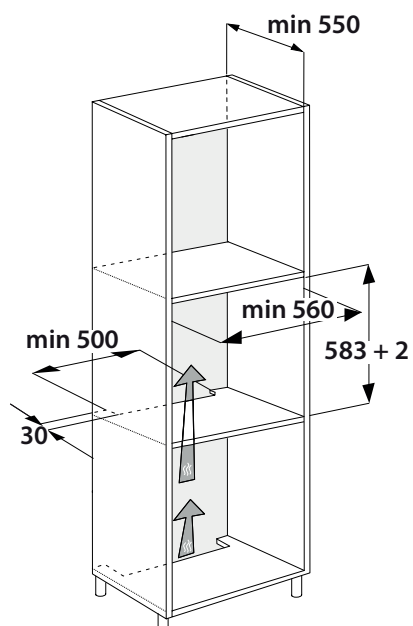
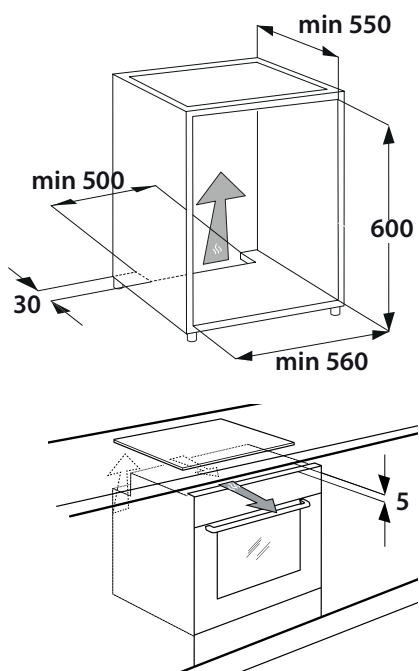
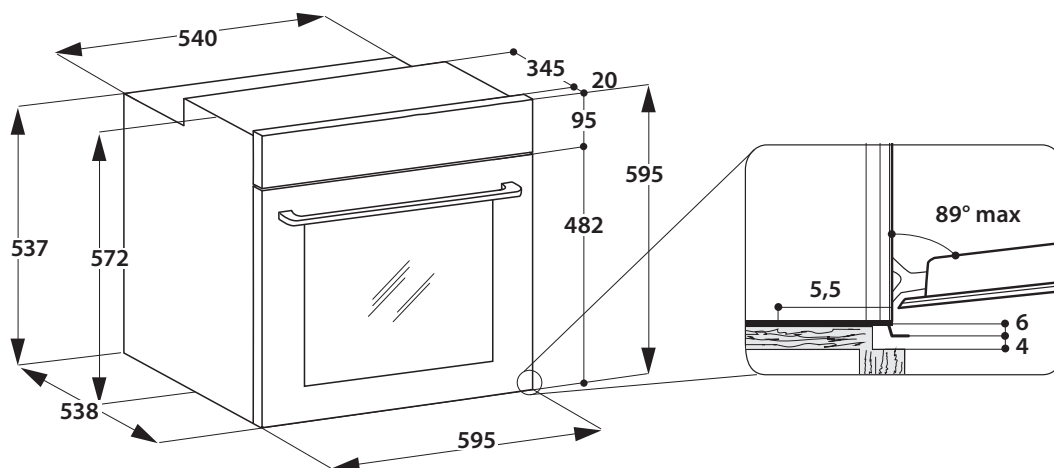
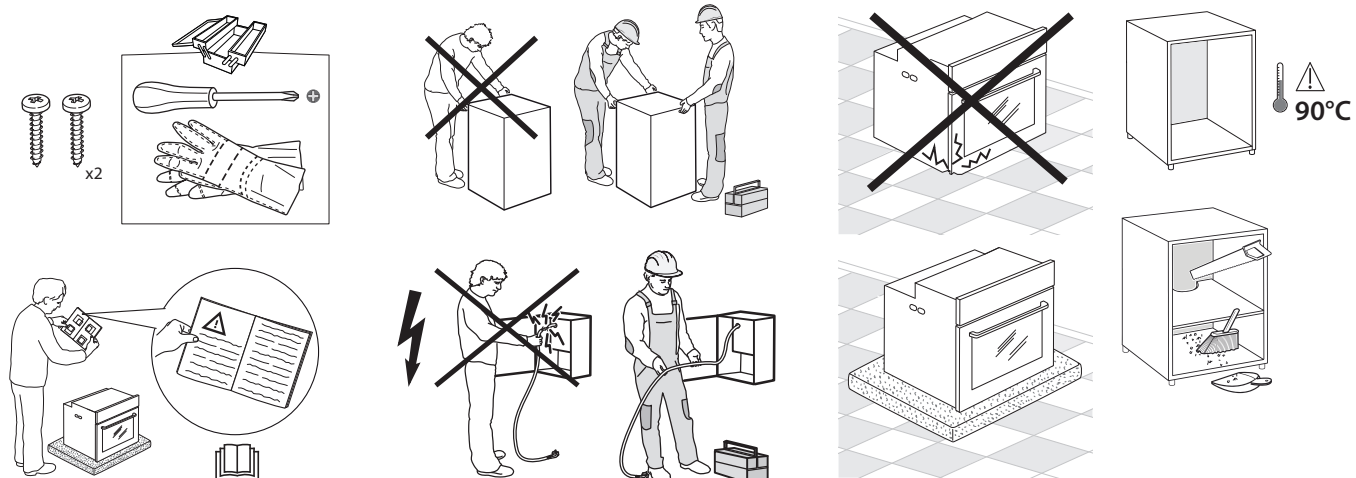
www.whirlpool.eu/register

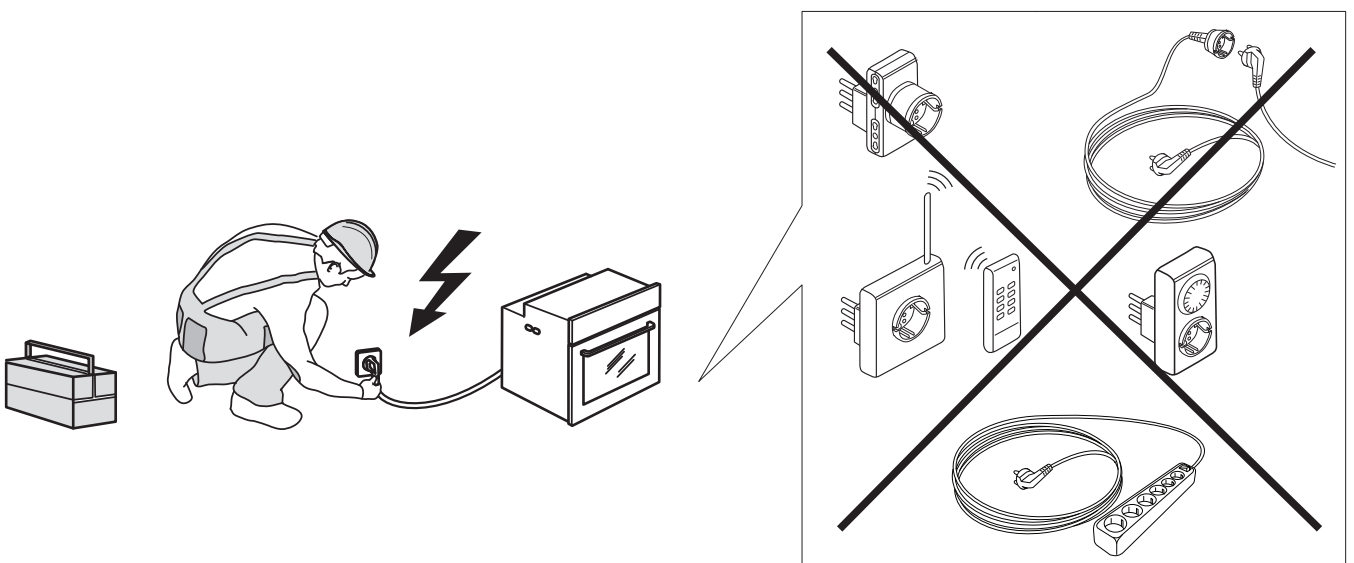
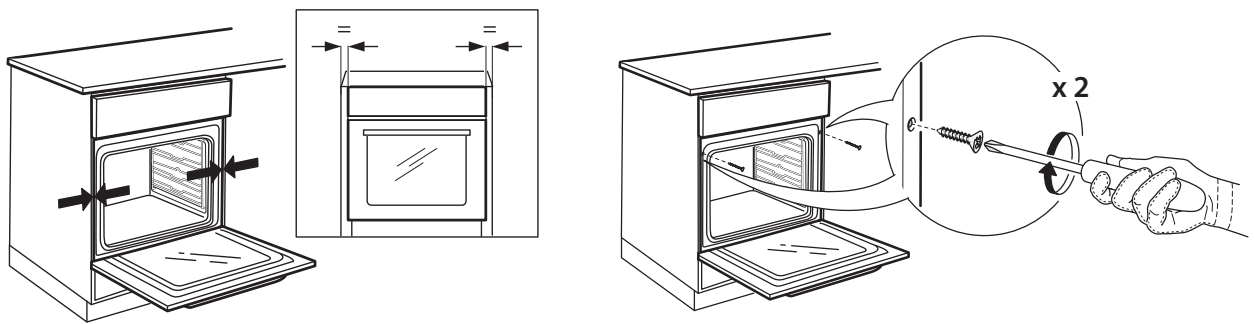
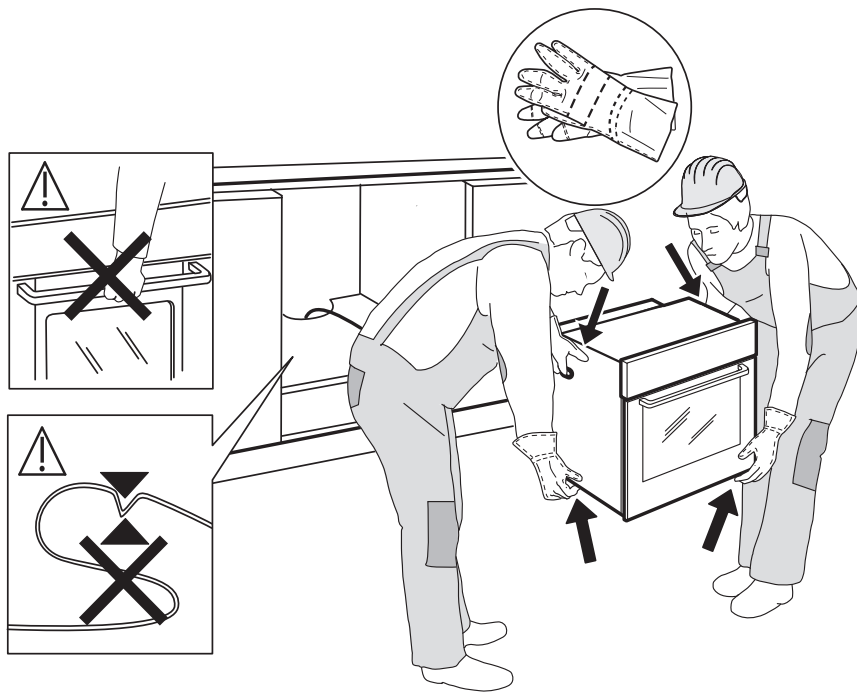


TABLE OF CONTENTS

INSTALLATION	3	 WIFI	15
SAFETY INSTRUCTIONS	5	 INFO	15
PRODUCT DESCRIPTION	7		
ACCESSORIES	8	COOKING TIPS	16
INSERTING THE WIRE SHELF AND OTHER ACCESSORIES	8	CONVENTIONAL	16
REMOVING AND REFITTING THE SHELF GUIDES	8	GRILL	17
FITTING THE SLIDING RUNNERS (IF PRESENT)	8	TURBO GRILL	17
COOKING FUNCTIONS	9	FORCED AIR	18
HOW TO USE THE TOUCH DISPLAY	10	COOK 4	19
FIRST TIME USE	10	CONVECTION BAKE	19
1. SELECT THE LANGUAGE	10	MAXI COOKING	19
2. SELECT SETTINGS MODE	10	ECO FORCED AIR	19
3. SETTING UP WIFI	10	USING THE FOOD PROBE	20
4. SETTING THE TIME AND DATE	10	RISING	20
5. SET THE POWER CONSUMPTION	11	WARM KEEPING	20
6. HEAT THE OVEN	11	DEFROSTING	20
DAILY USE	11	 COOKING TABLE	21
1. SELECT A FUNCTION	12	CLEANING AND MAINTENANCE	25
2. SET MANUAL FUNCTIONS	12	EXTERIOR SURFACES	25
TEMPERATURE / GRILL LEVEL	12	INTERIOR SURFACES	25
DURATION	12	ACCESSORIES	25
3. SET 6 th SENSE FUNCTIONS	12	REMOVING AND REFITTING THE DOOR	25
4. SET START / END TIME DELAY	13	REPLACING THE LAMP	26
5. START THE FUNCTION	13	WIFI FAQs	26
6. PREHEATING	13	TROUBLESHOOTING	27
7. PAUSING COOKING	13	AFTER-SALES SERVICE	28
8. END OF COOKING	13	BEFORE CONTACTING OUR	
9. FAVORITES	14	AFTER-SALES SERVICE	28
HOW TO SAVE A FUNCTION	14	IF THE PROBLEM PERSISTS	28
ONCE SAVED	14	TECHNICAL DATA	28
CHANGING THE SETTINGS	14		
10. TOOLS	14		
 REMOTE ENABLE	14		
 KITCHEN TIMER	14		
 LIGHT	15		
 SELF-CLEAN	15		
 PROBE	15		
 MUTE	15		
 CONTROL LOCK	15		
 MORE MODES	15		
 PREFERENCES	15		

INSTALLATION





SAFETY INSTRUCTIONS

Before using the appliance, read these safety instructions. Keep them nearby for future reference. These instructions and the appliance itself provide important safety warnings, to be observed at all times. The manufacturer declines any liability for failure to observe these safety instructions, for inappropriate use of the appliance or incorrect setting of controls.

⚠ Very young children (0-3 years) should be kept away from the appliance. Young children (3-8 years) should be kept away from the appliance unless continuously supervised. Children from 8 years old and above and persons with reduced physical, sensory or mental capabilities or lack of experience and knowledge can use this appliance only if they are supervised or have been given instructions on safe use and understand the hazards involved. Children must not play with the appliance. Cleaning and user maintenance must not be carried out by children without supervision.

⚠ **WARNING:** The appliance and its accessible parts become hot during use. Care should be taken to avoid touching heating elements. Children less than 8 years of age must be kept away unless continuously supervised.

⚠ Never leave the appliance unattended during food drying. If the appliance is suitable for probe usage, only use a temperature probe recommended for this oven - risk of fire.

⚠ Keep clothes or other flammable materials away from the appliance, until all the components have cooled down completely - risk of fire. Always be vigilant when cooking foods rich in fat, oil or when adding alcoholic beverages - risk of fire. Use oven gloves to remove pans and accessories. At the end of cooking, open the door with caution, allowing hot air or steam to escape gradually before accessing the cavity - risk of burns. Do not obstruct hot air vents at the front of the oven - risk of fire.

⚠ Exercise caution when the oven door is in the open or down position, to avoid hitting the door.

PERMITTED USE

⚠ **CAUTION:** The appliance is not intended to be operated by means of an external switching device, such as a timer, or separate remote controlled system.

⚠ This appliance is intended to be used in household and similar applications such as: staff kitchen areas in shops, offices and other working environments; farm houses; by clients in hotels, motels, bed & breakfast and other residential environments.

⚠ No other use is permitted (e.g. heating rooms).

⚠ This appliance is not for professional use. Do not

IMPORTANT TO BE READ AND OBSERVED

use the appliance outdoors.

⚠ Do not store explosive or flammable substances (e.g. gasoline or aerosol cans) inside or near the appliance - risk of fire.

INSTALLATION

⚠ The appliance must be handled and installed by two or more persons - risk of injury. Use protective gloves to unpack and install - risk of cuts.

⚠ Installation, including water supply (if any), electrical connections and repairs must be carried out by a qualified technician. Do not repair or replace any part of the appliance unless specifically stated in the user manual. Keep children away from the installation site. After unpacking the appliance, make sure that it has not been damaged during transport. In the event of problems, contact the dealer or your nearest After-sales Service. Once installed, packaging waste (plastic, styrofoam parts etc.) must be stored out of reach of children - risk of suffocation. The appliance must be disconnected from the power supply before any installation operation - risk of electric shock. During installation, make sure the appliance does not damage the power cable - risk of fire or electric shock. Only activate the appliance when the installation has been completed.

⚠ Carry out all cabinet cutting operations before fitting the appliance and remove all wood chips and sawdust.

Do not obstruct the minimum gap between the worktop and the upper edge of the oven - risk of burns.

Do not remove the oven from its polystyrene foam base until the time of installation.

⚠ After installation, the bottom of the appliance must no longer be accessible - risk of burns.

⚠ Do not install the appliance behind a decorative door - risk of fire.

ELECTRICAL WARNINGS

⚠ The rating plate is on the front edge of the oven (visible when the door is open).

⚠ It must be possible to disconnect the appliance from the power supply by unplugging it if plug is accessible, or by a multi-pole switch installed upstream of the socket in accordance with the wiring rules and the appliance must be earthed in conformity with national electrical safety standards.

⚠ Do not use extension leads, multiple sockets or adapters. The electrical components must not be accessible to the user after installation. Do not use the appliance when you are wet or barefoot. Do not operate this appliance if it has a damaged power

cable or plug, if it is not working properly, or if it has been damaged or dropped.

⚠ If the supply cord is damaged, it must be replaced with an identical one by the manufacturer, its service agent or similarly qualified persons in order to avoid a hazard - risk of electric shock.

⚠ In case of replacement of power cable, contact an authorised service centre.

CLEANING AND MAINTENANCE


⚠ **WARNING:** Ensure that the appliance is switched off and disconnected from the power supply before performing any maintenance operation; never use steam cleaning equipment - risk of electric shock.

⚠ Do not use harsh abrasive cleaners or metal scrapers to clean the door glass since they can scratch the surface, which may result in shattering of the glass.

⚠ Ensure the appliance is cooled down before any cleaning or maintenance - risk of burns.

⚠ **WARNING:** Switch off the appliance before replacing the lamp - risk of electric shock.


DISPOSAL OF PACKAGING MATERIALS

The packaging material is 100% recyclable and is marked with the recycle symbol .

The various parts of the packaging must therefore be disposed of responsibly and in full compliance with local authority regulations governing waste disposal.

DISPOSAL OF HOUSEHOLD APPLIANCES

This appliance is manufactured with recyclable or reusable materials. Dispose of it in accordance with local waste disposal regulations. For further information on the treatment, recovery and recycling of household electrical appliances, contact your local authority, the collection service for household waste or the store where you purchased the appliance. This appliance is marked in compliance with European Directive 2012/19/EU, Waste Electrical and Electronic Equipment (WEEE). By ensuring this product is disposed of correctly, you will help prevent negative consequences for the environment and human health.

The symbol  on the product or on the accompanying documentation indicates that it should not be treated as domestic waste but must be taken to an appropriate collection centre for the recycling of electrical and electronic equipment.

ENERGY SAVING TIPS

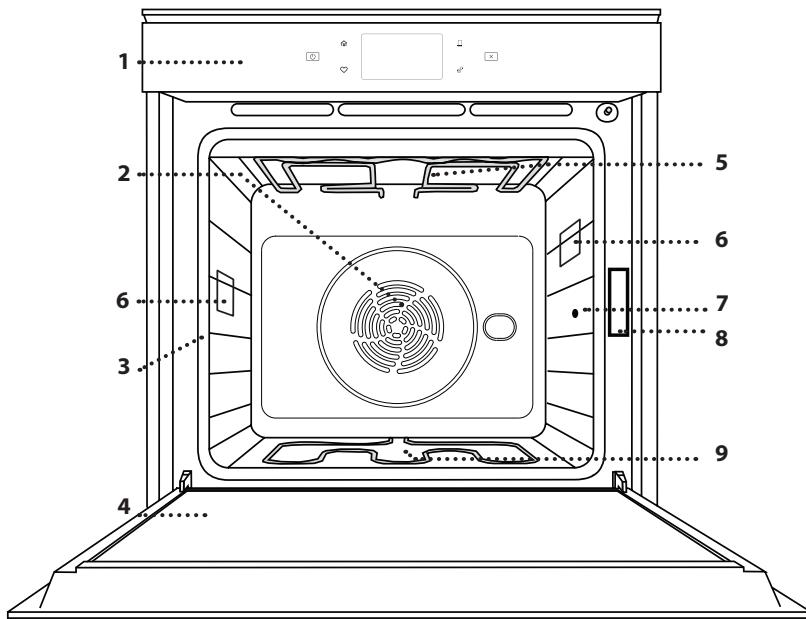
Only preheat the oven if specified in the cooking table or your recipe. Use dark lacquered or enamelled baking trays as they absorb heat better. Food requiring prolonged cooking will continue to cook even once the oven is switched off.

ECO DESIGN DECLARATION

This appliance meets the Eco Design requirements of European Regulations n. 65/2014 and 66/2014 in conformity with the European standard EN 60350-1.

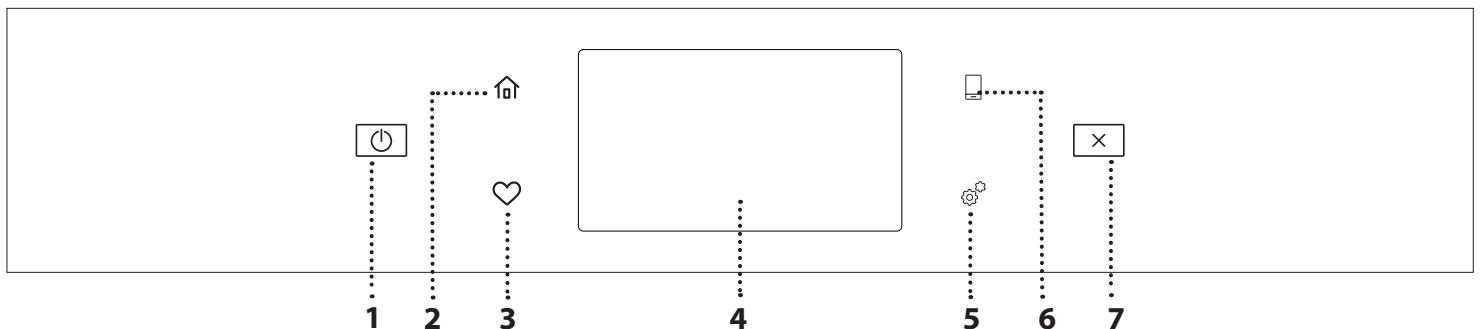
The Manufacturer, Whirlpool EMEA S.p.A., declares that this W111OM1 4MS2 H model of household appliance with radio equipment Indigo WiFi Module is compliant with directive 2014/53/UE. The complete text of the declaration of conformity is present at the following website: docs.whirlpool.eu
The radio equipment operates in the 2.4 GHz ISM frequency band, the maximum radio-frequency power transmitted does not exceed 20 dBm (e.i.r.p.).
This product includes certain open source software developed by third parties. The open source license usage statement is available at the following website: docs.whirlpool.eu

PRODUCT DESCRIPTION



1. Control panel
2. Fan and circular heating element (not visible)
3. Shelf guides (the level is indicated on the front of the oven)
4. Door
5. Upper heating element/grill
6. Lamp
7. Food probe insert point
8. Identification plate (do not remove)
9. Lower heating element (not visible)

CONTROL PANEL DESCRIPTION



1. ON / OFF

For switching the oven on and off.

2. HOME

For gaining quick access to the main menu.

3. FAVORITE

For retrieving up the list of your favorite functions.

4. DISPLAY

5. TOOLS

To choose from several options and also change the oven settings and preferences.

6. REMOTE CONTROL

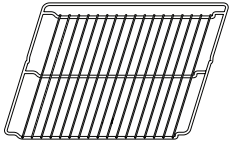
To enable use of the 6th Sense Live Whirlpool app.

7. CANCEL

To stop any oven function except the Clock, Kitchen Timer and Control Lock.

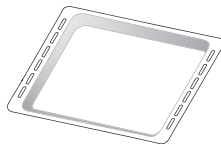
ACCESSORIES

WIRE SHELF



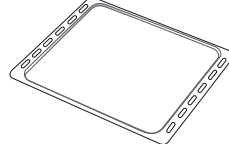
Use to cook food or as a support for pans, cake tins and other ovenproof items of cookware

DRIP TRAY



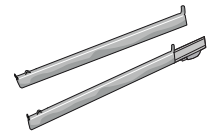
Use as an oven tray for cooking meat, fish, vegetables, focaccia, etc. or position underneath the wire shelf to collect cooking juices.

BAKING TRAY



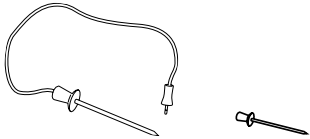
Use for cooking all bread and pastry products, but also for roasts, fish en papillote, etc.

SLIDING RUNNERS *



To facilitate inserting or removing accessories.

FOOD PROBE



To accurately measure the core temperature of food during cooking. Thanks to its four sensing points and rigid support, it can be used for meat and fish, and also for bread, cakes and baked pastries.

* Available only on certain models

The number and the type of accessories may vary depending on which model is purchased.

Other accessories can be purchased separately from the After-sales Service.

INSERTING THE WIRE SHELF AND OTHER ACCESSORIES

Insert the wire shelf horizontally by sliding it across the shelf guides, making sure that the side with the raised edge is facing upwards.

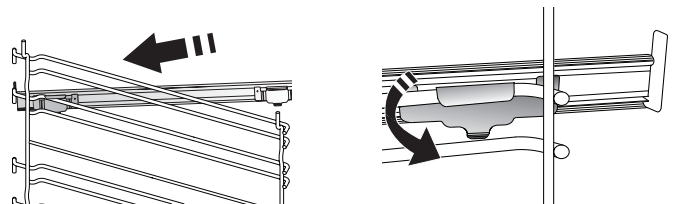
Other accessories, such as the drip tray and the baking tray, are inserted horizontally in the same way as the wire shelf.

REMOVING AND REFITTING THE SHELF GUIDES

- To remove the shelf guides, lift the guides up and then gently pull the lower part out of its seating: The shelf guides can now be removed.
- To refit the shelf guides, first fit them back into their upper seating. Keeping them held up, slide them into the cooking compartment, then lower them into position in the lower seating.

FITTING THE SLIDING RUNNERS (IF PRESENT)

Remove the shelf guides from the oven and remove the protective plastic from the sliding runners. Fasten the upper clip of the runner to the shelf guide and slide it along as far as it will go. Lower the other clip into position. To secure the guide, press the lower portion of the clip firmly against the shelf guide. Make sure that the runners can move freely. Repeat these steps on the other shelf guide on the same level.



Please note: The sliding runners can be fitted on any level.

COOKING FUNCTIONS



MANUAL FUNCTIONS

- **FAST PREHEAT**
For preheating the oven quickly.
- **CONVENTIONAL**
For cooking any kind of dish on one shelf only.
- **GRILL**
For grilling steaks, kebabs and sausages, cooking vegetables au gratin or toasting bread. When grilling meat, we recommend using a drip tray to collect the cooking juices: Position the tray on any of the levels below the wire shelf and add 500 ml of drinking water.
- **TURBO GRILL**
For roasting large joints of meat (legs, roast beef, chicken). We recommend using a drip tray to collect the cooking juices: Position the pan on any of the levels below the wire shelf and add 500 ml of drinking water.
- **FORCED AIR**
For cooking different foods that require the same cooking temperature on several shelves (maximum three) at the same time. This function can be used to cook different foods without odours being transferred from one food to another.
- **COOK 4 FUNCTIONS**
For cooking different foods that require the same cooking temperature on four levels at the same time. This function can be used to cook cookies, cakes, round pizzas (also frozen) and to prepare a complete meal. Follow the cooking table to obtain the best results.
- **CONVECTION BAKE**
For cooking meat, baking cakes with fillings on one shelf only.
- **SPECIAL FUNCTIONS**
 - » **DEFROST**
To speed up defrosting of food. Place food on the middle shelf. Leave food in its packaging to prevent it from drying out on the outside.
 - » **KEEP WARM**
For keeping just-cooked food hot and crisp.
 - » **RISING**
For optimal proving of sweet or savoury dough. To maintain the quality of proving, do not activate the function if the oven is still hot following a cooking cycle.
 - » **CONVENIENCE**
To cook ready-made food, stored at room temperature or in the refrigerator (biscuits, cake mix, muffins, pasta dishes and bread-type products). The function cooks all the dishes

quickly and gently and can also be used to heat food already cooked. The oven does not need to be pre-heated. Follow the instructions on the packaging.

- » **MAXI COOKING**

To cook large joints of meat (above 2.5 kg). It is advisable to turn the meat over during cooking, to obtain even browning on both sides. It is best to baste the meat every now and again to prevent it from drying out.

- » **ECO FORCED AIR**

For cooking stuffed roasting joints and fillets of meat on a single shelf. Food is prevented from drying out excessively by gentle, intermittent air circulation. When this ECO function is in use, the light will remain switched off during cooking. To use the ECO cycle and therefore optimise power consumption, the oven door should not be opened until the food is completely cooked.

- **FROZEN BAKE**

The function automatically selects the ideal cooking temperature and mode for 5 different types of ready frozen food. The oven does not have to be preheated.



6th SENSE

These enable all types of food to be cooked fully automatically. To use at best this function, follow the indications on the relative cooking table.

HOW TO USE THE TOUCH DISPLAY



To scroll through a menu or a list:
Simply swipe your finger across the display to scroll through the items or values.



To select or confirm:
Tap the screen to select the value or menu item you require.

FIRST TIME USE

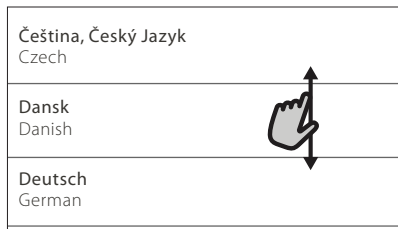
You will need to configure the product when you switch on the appliance for the first time.

The settings can be changed subsequently by pressing  to access the "Tools" menu.

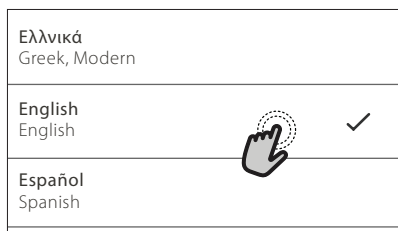
1. SELECT THE LANGUAGE


You will need to set the language and the time when you switch on the appliance for the first time.

- Swipe across the screen to scroll through the list of available languages.



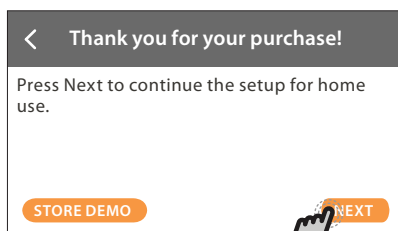
- Tap the language you require.



Tapping  will take you back to the previous screen.

2. SELECT SETTINGS MODE

Once you have selected the language, the display will prompt you to choose between "STORE DEMO" (useful for retailers, for display purposes only) or continue by tapping "NEXT".



To go back to the previous screen:

Tap .

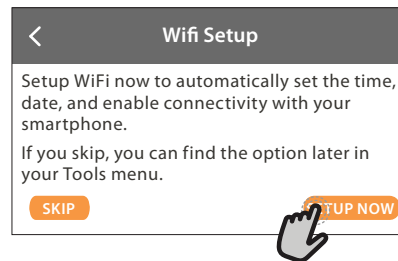
To confirm settings or access the next screen:

Tap "SET" or "NEXT".

3. SETTING UP WIFI

The 6th Sense Live feature allows you to operate the oven remotely from a mobile device. To enable the appliance to be controlled remotely, you will need to complete the connection process successfully first. This process is necessary to register your appliance and connect it to your home network.

- Tap "SETUP NOW" to proceed with setup connection.



Otherwise, tap "SKIP" to connect your product later.

HOW TO SET UP THE CONNECTION

To use this feature you will need: A smartphone or tablet and a wireless router connected to the Internet. Please use your smart device to check that your home wireless network's signal is strong close to the appliance.

Minimum requirements.

Smart device: Android with a 1280x720 (or higher) screen or iOS.

See on App store the app compatibility with Android or iOS versions.

Wireless router: 2.4Ghz WiFi b/g/n.

1. Download the 6th Sense Live app

The first step to connecting your appliance is to download the app on your mobile device. The 6th Sense Live app will guide you through all the steps listed here. You can download the 6th Sense Live app from the iTunes Store or the Google Play Store.

2. Create an account

If you haven't done so already, you'll need to create an account. This will enable you to network your appliances and also view and control them remotely.

3. Register your appliance

Follow the instructions in the app to register your appliance. You will need the Smart Appliance Identifier (SAID) number to complete the registration process. You can find its unique code on the identification plate attached to the product.

4. Connect to WiFi

Follow the scan-to-connect setup procedure. The app will guide you through the process of connecting your appliance to the wireless network in your home.

If your router supports WPS 2.0 (or higher), select "MANUALLY", then tap "WPS Setup": Press the WPS button on your wireless router to establish a connection between the two products.

If necessary, you can also connect the product manually using "Search for a network".

The SAID code is used to synchronise a smart device with your appliance.

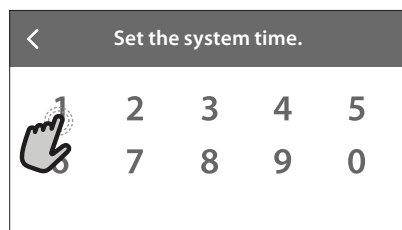
The MAC address is displayed for the WiFi module.

The connection procedure will only need to be carried out again if you change your router settings (e.g. network name or password or data provider).

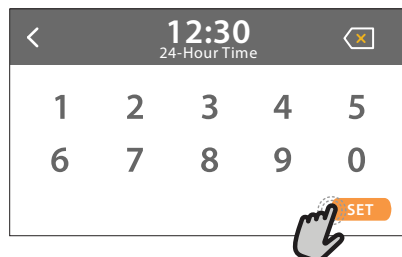
4. SETTING THE TIME AND DATE

Connecting the oven to your home network will set the time and date automatically. Otherwise you will need to set them manually.

- Tap the relevant numbers to set the time of the day.



- Tap "SET" to confirm.



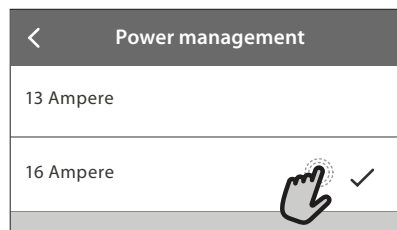
Once you have set the time, you will need to set the date.

- Tap the relevant numbers to set the date.
- Tap "SET" to confirm.

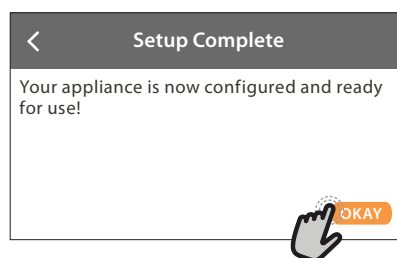
5. SET THE POWER CONSUMPTION

The oven is programmed to consume a level of electrical power that is compatible with a domestic network that has a rating of more than 3 kW (16 Ampere): If your household uses a lower power, you will need to decrease this value (13 Ampere).

- Tap the value on the right to select the power.



- Tap "OKAY" to complete the initial setup.



6. HEAT THE OVEN

A new oven may release odours that have been left behind during manufacturing: this is completely normal.

Before starting to cook food, we therefore recommend heating the oven with it empty in order to remove any possible odours.


Remove any protective cardboard or transparent film from the oven and remove any accessories from inside it.

Heat the oven to 200 °C for around one hour.

It is advisable to air the room after using the appliance for the first time.

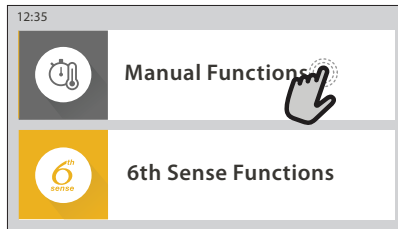
DAILY USE

1. SELECT A FUNCTION

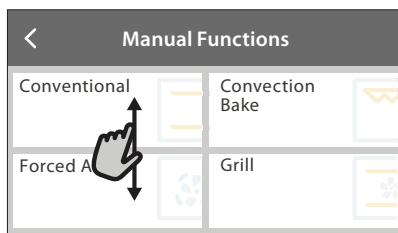
- To switch on the oven, press  or touch anywhere on the screen.

The display allows you to choose between Manual and 6th Sense Functions.

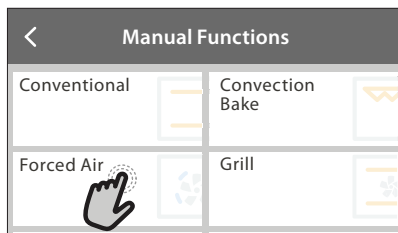
- Tap the main function you require to access the corresponding menu.



- Scroll up or down to explore the list.



- Select the function you require by tapping it.

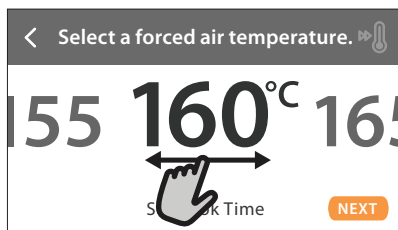



2. SET MANUAL FUNCTIONS

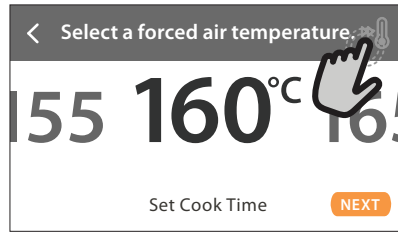
After having selected the function you require, you can change its settings. The display will show the settings that can be changed.

TEMPERATURE / GRILL LEVEL

- Scroll through the suggested values and select the one you require.



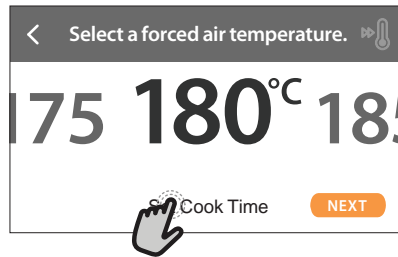
If allowed by the function, you can tap  to activate preheating.



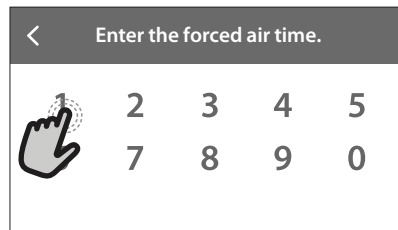
DURATION

You do not have to set the cooking time if you want to manage cooking manually. In timed mode, the oven cooks for the length of time you select. At the end of the cooking time, the cooking is stopped automatically.

- To set the duration, tap "Set Cook Time".



- Tap the relevant numbers to set the cooking time you require.



- Tap "NEXT" to confirm.

To cancel a set duration during cooking and so manage manually the end of cooking, tap the duration value and then select "STOP".

3. SET 6th SENSE FUNCTIONS

The 6th Sense functions enable you to prepare a wide variety of dishes, choosing from those shown in the list. Most cooking settings are automatically selected by the appliance in order to achieve the best results.

- Choose a recipe from the list.

Functions are displayed by food categories in the "6th SENSE FOOD" menu (see relative tables) and by recipe features in the "LIFESTYLE" menu.

- Once you have selected a function, simply indicate the characteristic of the food (quantity, weight, etc.) you want to cook to achieve the perfect result.

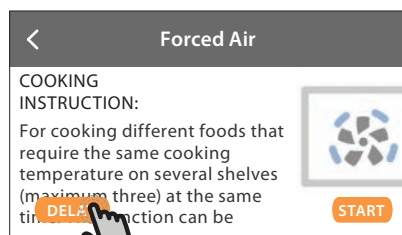
Some of the 6th Sense functions require use of the food probe. Plug it in before selecting the function. For best results with the probe, follow the suggestions in the relevant section.

- Follow the on-screen prompts to guide you through the cooking process.

4. SET START / END TIME DELAY


You can delay cooking before starting a function: The function will start or end at the time you select in advance.

- Tap “DELAY” to set the start time or end time you require.



- Once you have set the required delay, tap “START DELAY” to start the waiting time.
- Place the food in the oven and close the door: The function will start automatically after the period of time that has been calculated.

Programming a delayed cooking start time will disable the oven preheating phase: The oven will reach the temperature you require gradually, meaning that cooking times will be slightly longer than those listed in the cooking table.

- To activate the function immediately and cancel the programmed delay time, tap .

5. START THE FUNCTION

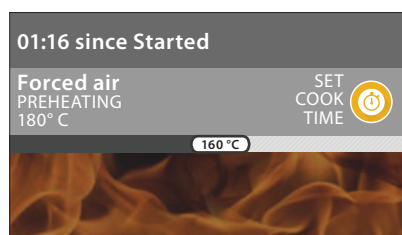
- Once you have configured the settings, tap “START” to activate the function.

If the oven is hot and the function requires a specific maximum temperature, a message will shown on the display. You can change the values that have been set at any time during cooking by tapping the value you want to amend.

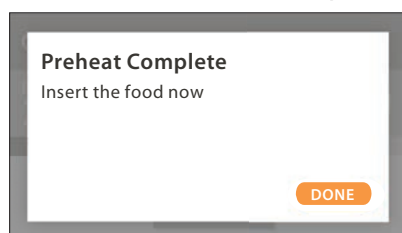
- Press  to stop the active function at any time.

6. PREHEATING

If previously activated, once the function has been started the display indicates the status of preheating phase.



Once this phase has been finished, an audible signal will sound and the display will indicate that the oven has reached the set temperature.



- Open the door.
- Place the food in the oven.

- Close the door and tap “DONE” to start cooking. Placing the food in the oven before preheating has finished may have an adverse effect on the final cooking result. Opening the door during the preheating phase will pause it. The cooking time does not include a preheating phase.

7. PAUSING COOKING

Some 6th Sense functions will require to turn the food during cooking. An audible signal will sound and the displays shows the action must to be done.

- Open the door.
- Carry out the action prompted by the display.
- Close the door, then tap “DONE” to resume cooking.

Before cooking ends, the oven could prompt you to check the food in the same way.

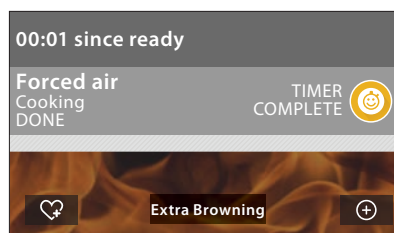
An audible signal will sound and the displays shows the action must to be done.



- Check the food.
- Close the door, then tap “DONE” to resume cooking.

8. END OF COOKING

An audible signal will sound and the display will indicate that cooking is complete.

With some functions, once cooking has finished you can give your dish extra browning, extend the cooking time or save the function as a favorite.




- Tap  to save it as a favorite.
- Select “Extra Browning” to start a five-minute browning cycle.
- Tap  to prolong the cooking.

9. FAVORITES

The Favorites feature stores the oven settings for your favorite recipes.

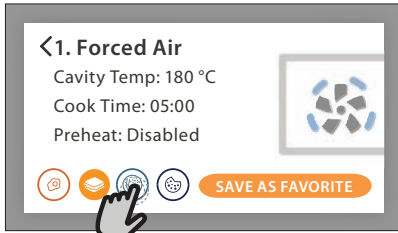
The oven automatically detects the functions you use most often. After a certain number of uses, you will be prompted to add the function to your favorites.

HOW TO SAVE A FUNCTION

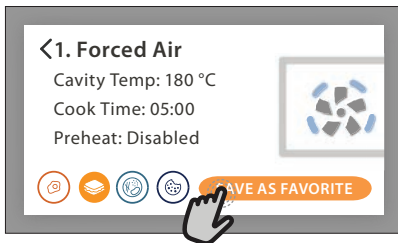
Once a function has finished, you can tap  to save it as favorite. This will enable you to use it quickly in the future, keeping the same settings.

The display allows you to save the function by indicating up to 4 favorite meal times, including breakfast, lunch, snack and dinner.

- Tap the icons to select at least one.

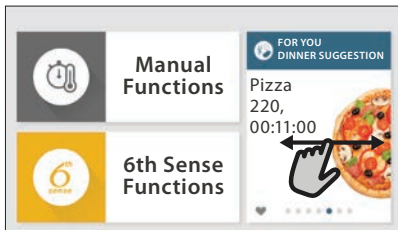



- Tap "SAVE AS FAVORITE" to save the function.



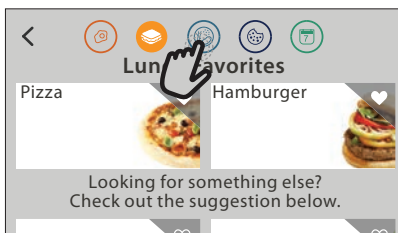
ONCE SAVED


Once you have saved functions as favorites, the main screen will display the functions you have saved for the current the time of day.



To view the favorites menu, press : The functions will be divided by different meal times and some suggestions will be offered.

- Tap the meals icon to show the relevant lists.



Tapping  also enables you to view your history of most recently used functions.

- Scroll through the prompted list.
- Tap the recipe or function you require.


- Tap "START" to activate the cooking.

CHANGING THE SETTINGS



In the Favorites screen, you can add an image or name to each favorite to customise it to your preferences.

- Select the function you want to change.
- Tap "EDIT".
- Select the attribute you want to change.
- Tap "NEXT": The display will show the new attributes.
- Tap "SAVE" to confirm your changes.

In the Favorites screen, you can also delete functions you have saved:

- Tap the  on the relevant function.
- Tap "REMOVE IT".

You can also change the time when the various meals are shown:

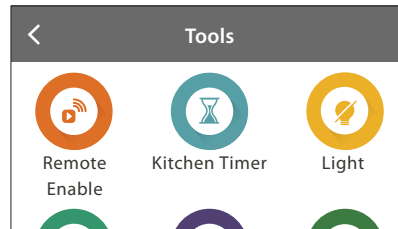
- Press .
- Select  "Preferences".
- Select "Times and Dates".
- Tap "Your Meal Times".
- Scroll through the list and tap the relevant time.
- Tap the relevant meal to change it.

Each time slot can be combined with one meal only.

10. TOOLS

Press  to open the "Tools" menu at any time.

This menu enables you to choose from several options and also change the settings or preferences for your product or the display.



REMOTE ENABLE

To enable use of the 6th Sense Live Whirlpool app.

KITCHEN TIMER

This function can be activated either when using a cooking function or alone for keeping time.

Once started, the timer will count down independently without interfering with the function itself.

The timer will continue counting down at the top-right corner of the screen.

The timer will continue counting down, shown on top-right corner of the screen.

To retrieve or change the kitchen timer:

- Press .
- Tap .

An audible signal will sound and the display will

indicate once the timer has finished counting down the selected time.

- Tap "DISMISS" to cancel the timer or set a new timer duration.
- Tap "SET NEW TIMER" to set the timer again.

LIGHT

To switch on or off the oven lamp.

SELF-CLEAN

Activate the "Self-Clean" function for optimum cleaning of the internal surfaces.

It is recommended to do not open the oven door during the cleaning cycle to avoid a loss of water vapor that could get an adverse effect on the final cleaning result.


- Remove all accessories from the oven before activating the function.
- When the oven is cold, pour 200 ml of drinking water on the bottom of the oven.
- Tap on "START" to activate the cleaning function.

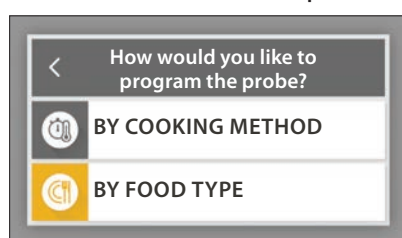
Once the cycle has been selected, it is possible to delay the start of the automatic cleaning. Tap on "DELAY" to set the end time as indicated in the relative paragraph.

PROBE

Using the probe enables you to measure the core temperature of the meat during cooking to ensure that it reaches the optimum temperature. The temperature of the oven varies according to the function that you have selected, but cooking is always programmed to finish once the specified temperature has been reached.

Place food in the oven and connect the food probe to the socket. Keep the probe as far away from the heat source as possible. Close the oven door.

Tap . You can choose between the manual (by cooking method) and 6th Sense (by food type) functions if use of the probe is allowed or required.



Once a cooking function has been started, it will be cancelled if the probe is removed.

Always unplug and remove the probe from the oven when taking out the food.

MUTE

Tap icon to mute or unmute all the sounds and alarms.

CONTROL LOCK

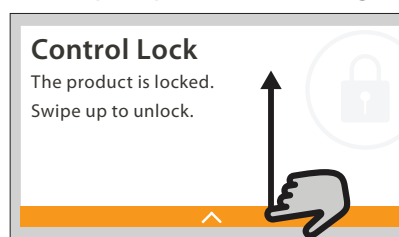
The "Control Lock" enables you to lock the buttons on the touch pad so they cannot be pressed accidentally.

To activate the lock:

- Tap the  icon.

To deactivate the lock:



- Tap the display.
- Swipe up on the message shown.



MORE MODES

For selecting Sabbath mode and accessing Power Management.

Sabbath mode keeps the oven on in baking mode until disabled. Sabbath mode uses the conventional function. All other cooking and cleaning cycles are disabled. No tones will sound, and the displays will not indicate temperature changes. When the oven door is opened or closed, the oven light will not turn on or off, and the heating elements will not turn on or off immediately.

To disable and exit Sabbath mode, press  or , then press and hold the display screen for 3 seconds.

PREFERENCES

For changing several oven settings.

WIFI

For changing settings or configuring a new home network.

INFO

For switching off "Store Demo Mode", resetting the product and obtaining further information about the product.

COOKING TIPS

HOW TO READ THE COOKING TABLES

The tables list: recipes, if preheating is needed, temperature (°C), grill level, cooking time (minutes), accessories and level suggested for cooking.

Cooking times start from the moment food is placed in the oven, excluding preheating (where required).

Cooking temperatures and times are approximate and depend on the amount of food and the type of accessory used. Use the lowest recommended values to begin with and, if the food is not cooked enough, move on to higher values.


Use the accessories supplied and preferably dark-coloured metal cake tins and oven trays. You can also use pans and accessories in pyrex or stoneware, but bear in mind that cooking times will be slightly longer. To obtain the best results, carefully follow the advice given in the cooking table for the choice of accessories (supplied) to be placed on the various shelves.

The tables list the following icons for indicating accessories:

 Wire Shelf

 Cake tin on wire shelf

 Drip tray / baking tray

 Drip tray / baking tray or oven tray on wire shelf

CONVENTIONAL

The heating elements at the top and bottom of the oven cavity heat the inside of the oven evenly.

Use the 3rd shelf. To cook pizza, savoury pies and sweets with liquid fillings, use the 1st or 2nd shelf.

Preheat the oven before placing food inside.

This function is the best cooking mode for cooking delicate desserts on one shelf only.

Use dark-coloured metal cake tins and always position them on the wire shelf supplied. When using the supplied trays, remove any other accessories you are not using from the oven cavity to achieve optimal results and save energy.

To check whether a cake is cooked, insert a wooden toothpick into the centre of the cake. If the toothpick comes out clean, the cake is ready.

If using non-stick cake tins, do not butter the edges as the cake may not rise evenly around the edges.

If the cake "sinks" during cooking, set a lower temperature the next time, perhaps reducing the amount of liquid in the mixture and mixing more gently.

The fish is cooked when the dorsal fin comes off easily. Begin by selecting the lowest indicated temperature, even when preparing larger fish. In general, the larger the fish, the lower the temperature must be and therefore the longer the cooking time.

Recipe	Preheat	Temperature (°C)	Cook Time (Min.)	Level and Accessories
Leavened cakes / Sponge cakes	Yes	170	30 - 50	 
Cookies / Shortbread	Yes	150	20 - 40	 
Small cakes / Muffin	Yes	170	20 - 40	 
Choux buns	Yes	180 - 200	30 - 40	 
Meringues	Yes	90	110 - 150	 
Pizza / Bread / Focaccia	Yes	190 - 250	15 - 50	 
Frozen pizza	Yes	250	10 - 15	 
Vols-au-vent / Puff pastry crackers	Yes	190 - 200	20 - 30	 
Lasagne / Flans / Baked pasta / Cannelloni	Yes	190 - 200	45 - 65	 
Lamb / Veal / Beef / Pork 1 kg	Yes	190 - 200	80 - 110	 
Chicken / Rabbit / Duck 1 kg	Yes	200 - 230	50 - 100	 
Turkey / Goose 3 kg	Yes	190 - 200	80 - 130	 
Baked fish / en papillote (fillets, whole)	Yes	180 - 200	40 - 60	 






GRILL

The top heating element enables optimum results to be achieved when grilling. Place food on the 4th or 5th shelf. When grilling meat, use the drip tray to collect the cooking juices. Position it on the 3rd/4th shelf, adding approx 500 ml of drinking water. The oven does not have to be preheated. During cooking, the oven door must remain closed.

If you want to grill meat, choose cuts with an even thickness all over in order to achieve uniform cooking results. Very thick pieces of meat require longer cooking times.

To prevent the meat from burning on the outside, lower the position of the wire shelf, keeping the food further away from the grill. Turn food halfway through cooking.

To collect the cooking juices it is advisable to place a drip-tray with half a litre of drinking water directly under the grill on which the meat is placed. Top-up when necessary.

Recipe	Preheat	Grill Level	Cook Time (Min.)	Level and Accessories
Toast	—	3 (High)	3 - 6	5 
Fish fillets / Steaks	—	2 (Mid)	20 - 30	4  
Sausages / Kebabs / Spare ribs / Hamburgers	—	2 - 3 (Mid - High)	15 - 30	5  

TURBO GRILL






In this function, the top heating element and the fan are activated at the same time.

Use the drip tray to collect the cooking juices. Position it on the 1st/2nd shelf, adding 500 ml of drinking water. The oven does not have to be preheated. During cooking the oven door must remain closed.

Turn food two thirds of the way through cooking (if

necessary).

Use any kind of oven tray or pyrex dish suited to the size of the piece of meat being cooked. For roast joints, it is best to add some stock to the bottom of the pan, basting the meat during cooking for added flavour. When the roast is ready, let it rest in the oven for another 10-15 minutes, or wrap it in aluminium foil.

Recipe	Preheat	Grill Level	Cook Time (Min.)	Level and Accessories
Roast chicken 1-1.3 kg	—	2 (Mid)	55 - 70	2  
Leg of lamb / Shanks	—	2 (Mid)	60 - 90	3 
Roast potatoes	—	2 (Mid)	35 - 55	3 
Vegetable gratin	—	3 (High)	10 - 25	3 

FORCED AIR






















































The round heating element and the fan are activated at the same time. The fan on the rear wall distributes the hot air evenly around the oven.

Using the "Forced Air" function, you can cook different foods which require the same cooking temperature at the same time (for example fish or vegetables), using different shelves. Remove the food which requires less cooking time and leave food which requires longer cooking time in the oven.

Use the 4th shelf to cook on one shelf only, the 1st and 4th to cook on two shelves, and the 1st, 3rd and 5th to cook on three shelves. Always place cake tins on the wire shelf. Preheat the oven before cooking.

















To achieve uniform browning, make sure that all portions of dough are the same thickness.

When cooking pizza, lightly grease the trays to ensure the pizza has a crispy base. Scatter the mozzarella over the pizza two thirds of the way through cooking.

Recipe	Preheat	Temperature (°C)	Cook Time (Min.)	Level and Accessories
Leavened cakes / Sponge cakes	Yes	160	30 - 50	
	Yes	160	30 - 50	 
Filled cakes (cheesecake, strudel, apple pie)	Yes	160 - 200	35 - 90	 
Cookies / Shortbread	Yes	140	30 - 50	
	Yes	140	30 - 50	 
	Yes	135	40 - 60	  
Small cakes / Muffin	Yes	150	30 - 50	
	Yes	150	30 - 50	 
	Yes	150	40 - 60	  
Choux buns	Yes	180 - 190	35 - 45	 
	Yes	180 - 190	35 - 45 *	  
Meringues	Yes	90	130 - 150	 
	Yes	90	140 - 160 *	  
Pizza / Bread / Focaccia	Yes	190 - 230	20 - 50	 
Pizza (Thin, thick, focaccia)	Yes	220 - 240	25 - 50 *	  
Frozen pizza	Yes	250	10 - 20	 
	Yes	220 - 240	15 - 30	  
Savoury pies (vegetable pie, quiche)	Yes	180 - 190	45 - 60	 
	Yes	180 - 190	45 - 70 *	  
Vols-au-vent / Puff pastry crackers	Yes	180 - 190	20 - 40	 
	Yes	180 - 190	20 - 40 *	  
Lasagna & Meat	Yes	200	50 - 100 *	 
Meat & Potatoes	Yes	200	45 - 100 *	 
Fish & Vegetables	Yes	180	30 - 50 *	 

* Estimated length of time: dishes can be removed from the oven at different times depending on personal preference.

COOK 4

Recipe	Dish	Preheat	Temperature (°C)	Cook Time (Min.)	Level and Accessories
Cookies	Cookies	Yes	135	50 - 70	   
Tarts	Tarts	Yes	170	50 - 70	   
Round pizzas	Round Pizza	Yes	210	40 - 60	   
Complete meal: Fruit tart (level 5) roasted vegetables (level 4) lasagna (level 2) cuts of meat (level 1)	Cook 4 menu	Yes	190	40 - 120	   




CONVECTION BAKE

Use this function for quiches and vegetable tarts or desserts with moist fillings, such as or cheesecake and fruit pie.

It is also ideal for cooking foods with a high water content. The fan distributes heat evenly throughout the oven. This helps to maintain a constant temperature and cook food more evenly, crisping up the top while sealing in moisture and creating crustier breads.

Use the 3rd or the 2nd shelf. Wait for the end of preheating before placing food inside.

If the pastry base is soggy, lower the shelf and sprinkle the bottom of the cake with biscuit crumbs before adding the filling.

Recipe	Preheat	Temperature (°C)	Cook Time (Min.)	Level and Accessories
Filled cakes (cheesecake, strudel, apple pie)	Yes	160 - 200	30 - 85	
Savoury pies (vegetable pie, quiche)	Yes	180 - 190	45 - 55	
Stuffed vegetables (tomatoes, courgettes, aubergines)	Yes	180 - 200	50 - 60	

MAXI COOKING

This function is very useful for cooking large joints of meat (over 2.5 kg). It is advisable to turn the meat over during cooking for more even browning. It is best to baste the meat every now and again to prevent it from drying out.

Use the 1st or 2nd shelves, depending on the size of the joint. The oven does not have to be preheated before cooking.

For roast joints, it is best to add some stock to the bottom of the pan, basting the meat during cooking for added flavour. When the roast is ready, let it rest in the oven for another 10-15 minutes, or wrap it in aluminium foil.



If the meat is too lean, add a little liquid, drizzle the joint with fat, or cover it with strips of bacon, for example.

In terms of turning the roast, make sure you place it rind-side down first.

Recipe	Preheat	Temperature (°C)	Cook Time (Min.)	Level and Accessories
Roast pork with crackling 2 kg	—	170	110 - 150	

ECO FORCED AIR

It is advisable to use the 3rd level. The oven does not have to be preheated.

Recipe	Preheat	Temperature (°C)	Cook Time (Min.)	Level and Accessories
Stuffed roasting joints	—	200	80 - 120 *	
Cuts of meat (rabbit, chicken, lamb)	—	200	50 - 100 *	

* Estimated length of time: dishes can be removed from the oven at different times depending on personal preference.

USING THE FOOD PROBE

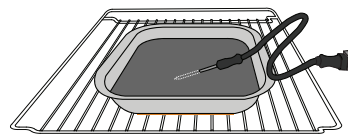
Place the food in the oven and connect the plug by inserting it into the connection provided on the righthand side of the oven's cooking compartment. The cable is semi-rigid and can be shaped as needed to insert the probe into the food in the most effective way. Make sure that the cable does not touch the top heating element during cooking.

MEAT: Insert the probe deep into the meat, avoiding bones or fatty areas. For poultry, insert the probe lengthways into the centre of the breast, avoiding hollow areas.

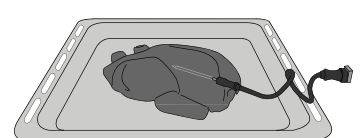
FISH (whole): Position the tip in the thickest part, avoiding the thorns.

OVEN BAKING: Insert the tip deep into the dough by shaping the cable to achieve the optimum probe angle.

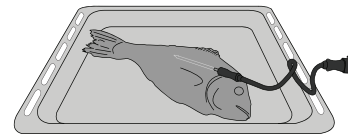
If you use the probe when cooking with the 6th Sense functions, cooking will be stopped automatically when the selected recipe reaches the ideal core temperature, without the need to set the oven temperature.



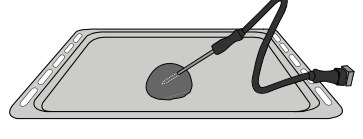
Lasagna



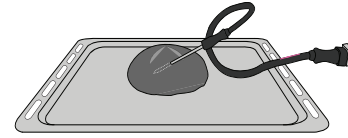
Whole Chicken



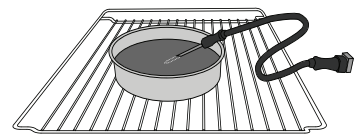
Fish



Rolls



Big Bread



Cake

RISING

It is always best to cover the dough with a damp cloth before placing it in the oven. Dough proving time with this function is reduced by approximately one third compared to proving at room temperature (20-25°C).

Proving time for a 1 kg batch of pizza dough is around one hour.

WARM KEEPING

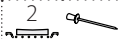
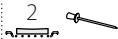

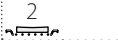
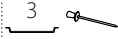
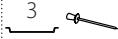





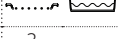
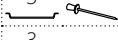




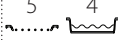

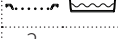
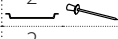
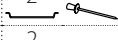
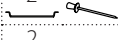


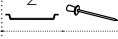
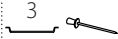



The keep warm function enables you to keep ready-made meals warm. This prevents condensation from forming and eliminates the need to clean the cooking compartment.

It is not advisable to keep ready-made meals warm for over two hours.


Remember that some foods continue cooking while they are kept warm: Cover them, if necessary, to prevent them drying out.


DEFROSTING

Boiled foods, stews and meat-based sauces will defrost better if stirred occasionally while defrosting. Separate the food items once they begin to defrost: the separated portions will defrost more quickly.

	Food categories	Level and Accessories	Quantity	Cooking Info	
CASSEROLE & BAKED PASTA	Fresh	Lasagna	2 	500 - 3000 g *	Prepare according to your favorite recipe. Pour bechamel sauce on top and sprinkle with cheese to get perfect browning
		Cannelloni	2 	500 - 3000 g *	
Frozen	Lasagna	2 	500 - 3000 g		
	Cannelloni	2 	500 - 3000 g		
MEAT	Beef	Roast beef	3 	600 - 2000 g *	Brush with oil and rub with salt and pepper. Season with garlic and herbs as you prefer. At the end of cooking let rest for at least 15 minutes before carving
		Roast veal	3 	600 - 2500 g *	
		Steak	5  4 	2 - 4 cm	Brush with oil and rosemary. Rub with salt and black pepper. Distribute evenly on the wire rack. Turn at 2/3 of cooking time
		Hamburger	5  4 	1.5 - 3 cm	Brush with oil and sprinkle with salt before cooking. Turn at 3/5 of cooking time.
	Pork	Slow cooking	3 	600 - 2000 g *	Brush with oil and rub with salt and pepper. Season with garlic and herbs as you prefer. At the end of cooking let rest for at least 15 minutes before carving
		Roast Pork	3 	600 - 2500 g *	
		Pork Shank	3 	500 - 2000 g *	
		Pork Ribs	5  4 	500 - 2000 g	Brush with oil and sprinkle with salt before cooking. Turn at 2/3 of cooking time
	Lamb	Bacon	5  4 	250 g	Distribute evenly on the wire shelf. Turn at 3/4 of cooking time
		Roast Lamb	2 	600 - 2500 g *	Brush with oil and rub with salt and pepper. Season with garlic and herbs as you prefer. At the end of cooking let rest for at least 15 minutes before carving
		Lamb Rack	2 	500 - 2000 g *	
	Lamb Leg	2 	500 - 2000 g *		
Chicken	Roast Chicken	2 	600 - 3000 g *	Brush with oil and season as you prefer. Rub with salt and pepper. Insert into the oven with the breast side up	
	Stuffed Roast Chicken	2 	600 - 3000 g *		
	Chicken Pieces	3 	600 - 3000 g *	Brush with oil and season as you prefer. Distribute evenly in the drip tray with the skin side down	
	Chicken fillet / Breast	5  4 	1 - 5 cm	Brush with oil and sprinkle with salt before cooking. Turn at 2/3 of cooking time	
Roasted Duck	Roast Duck	2 	600 - 3000 g *	Brush with oil and rub with salt and pepper. Season with garlic and herbs as you prefer	
	Stuffed Roast Duck	2 	600 - 3000 g *		
	Duck Pieces	3 	600 - 3000 g *		
	Duck Fillet / Breast	5  4 	1 - 5 cm	Brush with oil and rub with salt and pepper. Season with garlic and herbs as you prefer. Turn at 2/3 of cooking time	

ACCESSORIES

 Wire shelf

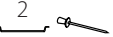
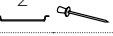



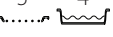

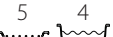




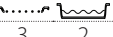


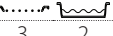


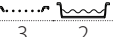











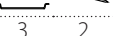


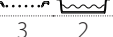





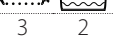





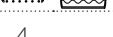

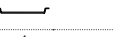





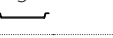


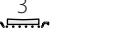


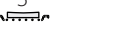
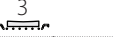
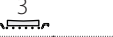
 Oven tray or cake tin on wire shelf

 Drip tray / Baking tray or oven tray on wire shelf

 Drip tray / Baking tray

 Drip tray with 500 ml of water


 * Food probe

	Food categories	Level and Accessories	Quantity	Cooking Info	
MEAT	Roasted Turkey & Goose	Roast Goose	2 	600 - 3000 g *	Brush with oil and rub with salt and pepper. Season with garlic and herbs as you prefer
		Stuffed Roast Goose	2 	600 - 3000 g *	
		Turkey Pieces	3 	600 - 3000 g *	
		Fillets / Breast	5  4 	1 - 5 cm	Brush with oil and season as you prefer. Rub with salt and pepper. Insert into the oven with the breast side up. Turn at 2/3 of cooking time
	Meat dishes	Kebabs	5  4 	1 grid	Brush with oil and sprinkle with salt before cooking. Turn at 1/2 of cooking time
		Sausages & Wurstel	5  4 	1.5 - 4 cm	Distribute evenly on the wire shelf. Pierce the sausages with a fork to avoid cracking. Turn at 2/3 of cooking time
FISH	Roasted whole fish	Salmon	3  2  	0.2 - 1.5 kg *	Brush with oil and rub with salt and pepper. Season with garlic and herbs as you prefer
		Hake	3  2  	0.2 - 1.5 kg *	
		Cod	3  2  	0.2 - 1.5 kg *	
		Seabass	3  2  	0.2 - 1.5 kg *	
		Seabream	3  2  	0.2 - 1.5 kg *	
		Mullet	3  2  	0.2 - 1.5 kg *	
		Whole Fish	3  2  	0.2 - 1.5 kg *	
		Fish In Salt Crust	3 	0.2 - 1.5 kg *	
Roasted fillets & steaks	Tuna Steak	3  2 	1 - 3 cm	Brush with oil and rub with salt and pepper. Season with garlic and herbs as you prefer	
	Salmon Steak	3  2 	1 - 3 cm		
	Swordfish Steak	3  2 	0.5 - 3 cm		
	Cod Steak	3  2 	100 - 300 g		
	Seabass Fillet	3  2 	50 - 150 g		
	Seabream Fillet	3  2 	50 - 150 g		
	Other Fillets	3  2 	0.5 - 3 cm		
	Fish Fillets	3  2 	0.5 - 3 cm		
Grilled seafood	Scallops	4 	one tray	Cover with breadcrumbs and season with oil, garlic, pepper and parsley	
	Gratin Mussels	4 	one tray		
	Shrimps	4  3 	one tray	Brush with oil and rub with salt and pepper. Season with garlic and herbs as you prefer	
	Prawns	4  3 	one tray		
VEGETABLES	Roasted Vegetables	Potatoes	3 	500 - 1500 g	Cut in pieces, season with oil, salt and flavor with herbs before insert into the oven
		Stuffed Vegetables	3 	100 - 500 g each	Brush with oil and rub with salt and pepper. Season with garlic and herbs as you prefer
		Other Vegetables	3 	500 - 1500 g	
	Gratin Vegetables	Potatoes	3 	1 tray	Cut in pieces, season with oil, salt and flavor with herbs before insert into the oven
		Tomatoes	3 	1 tray	Cover with breadcrumbs and season with oil, garlic, pepper and parsley
		Peppers	3 	1 tray	Prepare according to your favorite recipe. Sprinkle with cheese to get perfect browning
		Broccoli	3 	1 tray	Prepare according to your favorite recipe. Pour bechamel sauce on top and sprinkle with cheese to get perfect browning
		Cauliflowers	3 	1 tray	
		Others	3 	1 tray	

	Food categories	Level and Accessories	Quantity	Cooking Info
CAKES & PASTRIES	Rising cakes	Sponge Cake In Tin  2 	500 - 1200 g *	Prepare a fatless sponge cake batter of 500-900g. Pour into lined and greased baking pan
		Fruit Rising Cake In Tin  2 	500 - 1200 g *	Prepare a cake batter according to your favorite recipe by using shredded or chopped-sliced fresh fruit. Pour into lined and greased baking pan
		Chocolate Rising Cake In Tin  2 	500 - 1200 g *	Prepare a fatless sponge cake batter of 500-900g. Pour into lined and greased baking pan
		Sponge Cake in Baking Tray  2 	500 - 1200 g *	Prepare a fatless sponge cake batter of 500-900g. Pour into lined and greased baking tray
	Pastries & filled pies	Cookies  3	200 - 600 g	Make a batch of 500g flour, 200g salted butter, 200g sugar, 2 egg. Flavor with fruit essence. Let cool down. Stretch evenly the dough and shape as you prefer. Lay the cookies on a baking tray
		Croissants (fresh)  3	one tray	Distribute evenly in the baking tray. Let cool down before serving
		Croissants (frozen)  3	one tray	
		Choux Pastry  3	one tray	
		Meringues  3	10 - 30 g each	
		Tart In Tin  3	400 - 1600 g	Make a batch of 500g flour, 200g salted butter, 200g sugar, 2 egg. Flavor with fruit essence. Let cool down. Stretch evenly the dough and fold in a tin. Fill with marmalade and cook
		Strudel  3	400 - 1600 g	Prepare a mix of diced apple, pine nuts, cinnamon and nutmeg. Put some butter in a pan, sprinkle with sugar and cook for 10-15 minutes. Roll it into a pastry and fold the external part
		Fruit filled pie  3	500 - 2000 g	Line a pie dish with the pastry and sprinkle the bottom with bread crumbs to absorb the juice from the fruit. Fill with chopped fresh fruit mixed with sugar and cinnamon
	SALTY CAKES	Salty cake  2	800 - 1200 g	Line a pie dish for 8-10 portions with a pastry and pierce it with a fork, Fill the pastry according to your favorite recipe
		Vegetable Strudel  2	500 - 1500 g	Prepare a mix of chopped vegetable. Sprinkle with oil and cook into a pan for 15-20 minutes. Let cool down. Add fresh cheese and season with salt, balsamic vinegar and spices. Roll it into a pastry and fold the external part

ACCESSORIES

 Wire shelf




















 Oven tray or cake tin on wire shelf

 Drip tray / Baking tray or oven tray on wire shelf

 Drip tray / Baking tray


 Drip tray with 500 ml of water

 * Food probe

	Food categories	Level and Accessories	Quantity	Cooking Info	
BREAD	Rolls	3 	60 - 150 g each *	Prepare dough according to your favorite recipe for a light bread. Form to rolls before rise. Use the oven dedicated function to rise	
	Medium Size Bread	3 	200 - 500 g each *	Prepare dough according to your favorite recipe and place it on baking tray	
	Sandwich Loaf in Tin	2 	400 - 600g each *	Prepare dough according to your favorite recipe for a light bread. Form into a loaf container before rise. Use the oven dedicated function to rise	
	Big Bread	2 	700 - 2000 g *	Prepare dough according to your favorite recipe and place it on baking tray	
	Wholegrain	2 	500 - 2000 g *		
	Baguettes	3 	200 - 300g each *	Prepare dough according to your favorite recipe for a light bread. Form to baguette rolls before rise. Use the oven dedicated function to rise	
	Special Bread	2 	-	Prepare dough according to your favorite recipe and place it on baking tray	
PIZZA	Pizza Thin	2 	round - tray	Prepare a pizza dough based on 150ml water, 15g yeast, 200-225g flour, oil and salt. Rise it using the dedicated oven function. Roll out the dough into a lightly greased baking tray. Add topping like tomatoes, mozzarella and ham	
	Pizza Thick	2 	round - tray		
	Pizza Frozen	2 	1 - 4 layers		Take out from packaging. Distribute evenly on the wire shelf
		4  1 			
	5  3  1 				
	5  4  2  1 				

ACCESSORIES

 Wire shelf

 Oven tray or cake tin on wire shelf

 Drip tray / Baking tray or oven tray on wire shelf

 Drip tray / Baking tray

 Drip tray with 500 ml of water

 *Food probe

CLEANING AND MAINTENANCE

Make sure that the oven has cooled down before carrying out any maintenance or cleaning.
Do not use steam cleaners.

Do not use wire wool, abrasive scourers or abrasive/corrosive cleaning agents, as these could damage the surfaces of the appliance.

Wear protective gloves.
The oven must be disconnected from the mains before carrying out any kind of maintenance work.

EXTERIOR SURFACES

- Clean the surfaces with a damp microfibre cloth. If they are very dirty, add a few drops of pH-neutral detergent. Finish off with a dry cloth.
- Do not use corrosive or abrasive detergents. If any of these products inadvertently comes into contact with the surfaces of the appliance, clean immediately with a damp microfibre cloth.

INTERIOR SURFACES

- After every use, leave the oven to cool and then clean it, preferably while it is still warm, to remove any deposits or stains caused by food residues. To dry any condensation that has formed as a result

of cooking foods with a high water content, let the oven to cool completely and then wipe it with a cloth or sponge.

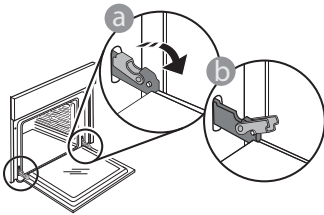
- Clean the glass in the door with a suitable liquid detergent.
- The oven door can be removed to facilitate cleaning.

ACCESSORIES

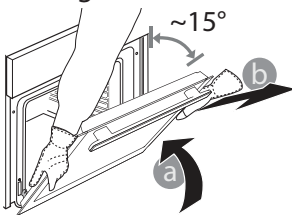
Soak the accessories in a washing-up liquid solution after use, handling them with oven gloves if they are still hot. Food residues can be removed using a washing-up brush or a sponge.

REMOVING AND REFITTING THE DOOR

1. To remove the door, open it fully and lower the catches until they are in the unlock position.

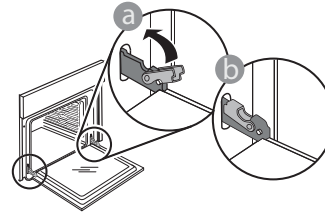


2. Close the door as much as you can. Take a firm hold of the door with both hands – do not hold it by the handle. Simply remove the door by continuing to close it while pulling it upwards at the same time until it is released from its seating. Put the door to one side, resting it on a soft surface.

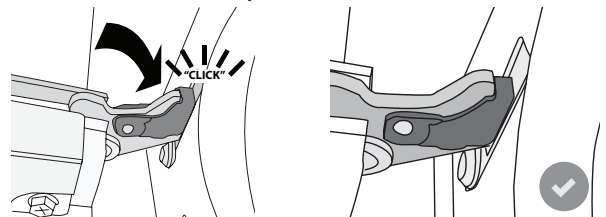


Refit the door by moving it towards the oven, aligning the hooks of the hinges with their seating and securing the upper part onto its seating.

3. Lower the door and then open it fully. Lower the catches into their original position: Make sure that you lower them down completely.



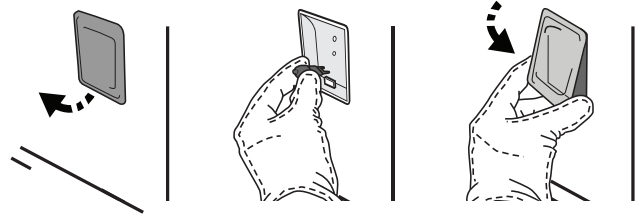
Apply gentle pressure to check that the catches are in the correct position.



4. Try closing the door and check to make sure that it lines up with the control panel. If it does not, repeat the steps above: The door could become damaged if it does not work properly.

REPLACING THE LAMP

- Disconnect the oven from the power supply.
- Remove the shelf guides.
- Remove the lamp cover.
- Replace the lamp.
- Reposition the lamp cover, pushing it on firmly until it snaps into place.
- Refit the shelf guides.
- Reconnect the oven to the power supply.



Please note: Only use 20-40 W/230 ~ V type G9, T300°C halogen bulbs. The bulb used in the product is specifically designed for domestic appliances and is not suitable for general room lighting within the home (EC Regulation 244/2009). Light bulbs are available from our After-sales Service.

Do not handle bulbs with your bare hands as your fingerprints could damage them. Do not use the oven until the light cover has been refitted.

WIFI FAQs

WiFi is not available in Russia

Which WiFi protocols are supported?

The WiFi adapter installed supports WiFi b/g/n for European countries.

Which settings need to be configured in the router software?

The following router settings are required: 2.4 GHz enabled, WiFi b/g/n, DHCP and NAT activated.

Which Version of WPS is supported?

WPS 2.0 or higher. Check the router documentation.

Are there any differences between using a smartphone (or tablet) with Android or iOS?

You can use whichever operating system you prefer, it makes no difference.

Can I use mobile 3G tethering instead of a router?

Yes, but cloud services are designed for permanently connected devices.

How can I check whether my home Internet connection is working and wireless functionality is enabled?

You can search for your network on your smart device. Disable any other data connections before trying.

How can I check whether the appliance is connected to my home wireless network?

Access your router configuration (see router manual) and check whether the appliance's MAC address is listed on wireless connected devices page.

Where can I find the appliance's MAC address?

Press then tap WiFi or look on your appliance: There is a label showing the SAID and MAC addresses. The MAC address consists of a combination of numbers and letters starting with "88:e7".

How can I check whether the appliance's wireless functionality is enabled?

Use your smart device and the 6th Sense Live app to check whether the appliance network is visible and connected to the cloud.

Is there anything that can prevent the signal reaching the appliance?

Check that the devices you have connected are not using up all the available bandwidth. Make sure that your WiFi-enabled devices do not exceed the maximum number permitted by the router.

How far should the router be from the oven?

Normally the WiFi signal is strong enough to cover a couple of rooms, but this very much depends on the material the walls are made of. You can check the signal strength by placing your smart device next to the appliance.

What can I do if my wireless connection does not reach the appliance?

You can use specific devices to extend your home WiFi coverage, such as access points, WiFi repeaters and power line bridges (not provided with appliance).

How can I find out the name of and password for my wireless network?

See the router documentation. There is usually a sticker on the router showing the information you need to reach the device setup page using a connected device.

What can I do if my router is using the neighbourhood WiFi channel?

Force the router to use your home WiFi channel.

What can I do if  appears on the display or the oven is unable to establish a stable connection to my home router?

The appliance might have successfully connected to the router, but it is not able to access the Internet. To connect the appliance to the Internet, you will need to check the router and/or carrier settings.

Router settings: NAT must be on, Firewall and DHCP must be properly configured. Password encryption supported: WEP, WPA, WPA2. To try a different encryption type, please refer to the router manual.

Carrier settings: If your Internet service provider has fixed the number of MAC addresses able to connect to the Internet, you may not be able to connect your appliance to the cloud. The MAC address of a device is its unique identifier. Please ask your Internet service provider how to connect devices other than computers to the Internet.

How can I check whether data is being transmitted?

After setting up the network, switch the power off, wait 20 seconds and then switch on the oven: Check that the app is showing the UI status of the appliance. Select a cycle or another option and check its status on the app.

Some settings take several seconds to appear in the app.











How can I change my Whirlpool account but keep my appliances connected?

You can make a new account but remember to unclaim your appliance from the old account before to move them to new one.

I changed my router – what do I need to do?

You can either keep the same settings (network name and password) or delete the previous settings from the appliance and configure the settings again.

TROUBLESHOOTING

Problem	Possible cause	Solution
The oven is not working.	Power cut. Disconnection from the mains.	Check for the presence of mains electrical power and whether the oven is connected to the electricity supply. Turn off the oven and restart it to see if the fault persists.
The display shows the letter "F" followed by a number or letter.	Oven failure.	Contact your nearest Client After-sales Service Centre and state the number following the letter "F". Press  , tap  "Info" and then select "Factory Reset". All settings saved will be deleted.
The home power goes off.	Power setting wrong.	Verify if your domestic network has at least a rating of more than 3 kW. If no, decrease the power to 13 Ampere. To change it, press  , select  "More Modes" and then select "Power Management".
The function does not start. The function is not available in demo mode.	Demo mode is running.	Press  , tap  "Info" and then select "Store Demo Mode" to exit.
The  icon is shown on display.	The WiFi router is off. The router settings have changed. The wireless connections does not reach the appliance. The oven is unable to establish a stable connection to home network. The connectivity is not supported.	Check that the WiFi router is connected to the Internet. Check that the WiFi signal close to the appliance is strong. Try to restart the router. See the "WiFi FAQs" section. If your home wireless network settings have changed, connect to the network: Press  , tap  "WiFi" and then select "Connect to network".
Connectivity is not supported.	Remote operation is not permitted in your country.	Check whether your country allows remote operation of electronic appliances before purchasing.
The touch screen display is not working properly.	Prolonged use. Overload system.	Press and hold  for at least 15 seconds. Switch the oven on and see if the fault persists.

AFTER-SALES SERVICE

BEFORE CONTACTING OUR AFTER-SALES SERVICE

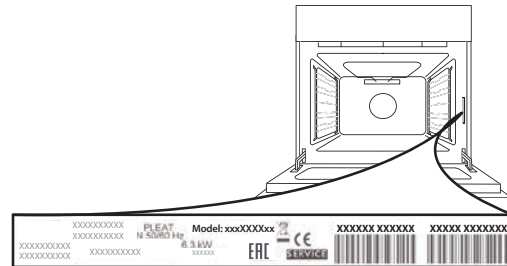
- Check whether you can resolve the problem yourself using any of the measures described in the Troubleshooting section.
- Turn the oven off and on again to see if the problem persists.

IF THE PROBLEM PERSISTS

AFTER HAVING PERFORMED ALL OF THE NECESSARY CHECKS, CONTACT YOUR NEAREST AFTER-SALES SERVICE CENTRE.

To receive assistance, call the number given on the warranty leaflet enclosed with the product or follow the instructions on our website. Be prepared to provide:

- a brief description of the problem;
- the exact model type of your product;
- the assistance code (the number following the word SERVICE on the identification plate attached to the product, which can be seen on the inside edge when the oven door is open);



- your full address;
- a contact telephone number.

TECHNICAL DATA

The product fiche with energy data of this appliance can be downloaded from Whirlpool website docs.whirlpool.eu



400011210390