

DAILY REFERENCE GUIDE



THANK YOU FOR PURCHASING A WHIRLPOOL PRODUCT

To receive more comprehensive help and support, please register your product at www.whirlpool.eu/register



You can download the Safety Instructions and the Use and Care Guide by visiting our website docs.whirlpool.eu and following the instructions on the back of this booklet.



Before using the appliance carefully read the Health and Safety guide.

PRODUCT DESCRIPTION

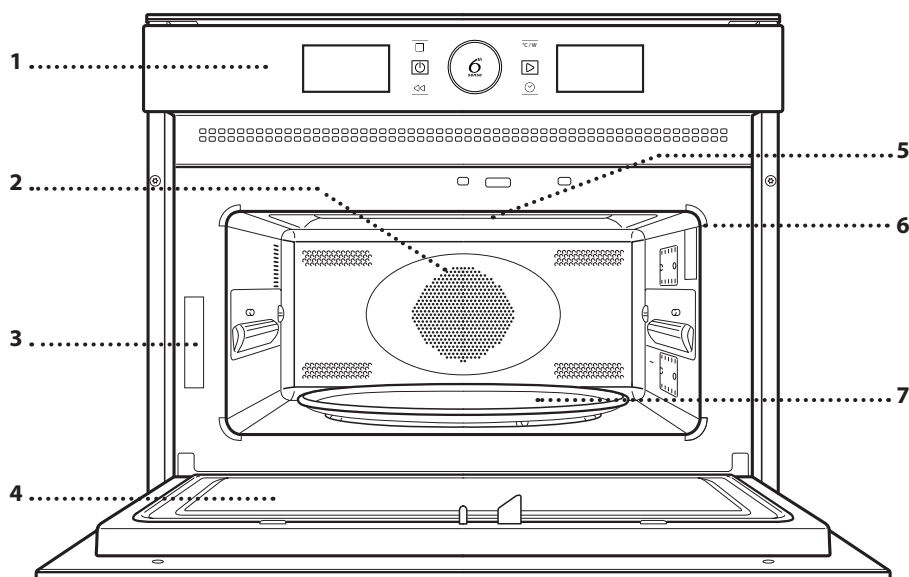

1. Control panel
2. Circular heating element (non-visible)
3. Identification plate (do not remove)
4. Door
5. Upper heating element/grill
6. Light
7. Turntable

CONTROL PANEL

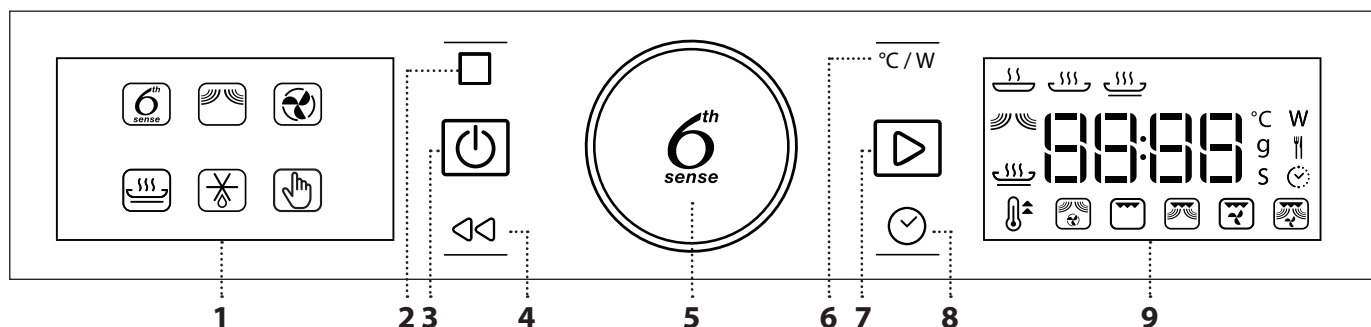

1. LEFT-HAND DISPLAY

2. PAUSE

To pause a cooking cycle

3. ON/OFF

For switching the oven on and off and for stopping an active function at any time.

4. BACK

For returning to the previous screen.

5. ROTARY KNOB / 6th SENSE BUTTON

Turn this to navigate through the functions and adjust all of the cooking parameters. Press  to select, set, access or confirm functions or parameters and eventually start the cooking program.

6. POWER

To adjust the temperature, grill level or microwave power.

7. START

For starting functions and confirming settings

8. TIME

For setting the time as well as setting or adjusting the cooking time.

9. RIGHT-HAND DISPLAY

ACCESSORIES

TURNTABLE

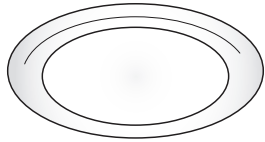

Placed on its support, the glass turntable can be used with all cooking methods. The turntable must always be used as a base for other containers or accessories, with the exception of the rectangular baking tray.

TURNTABLE SUPPORT

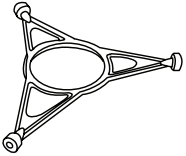

Only use the support for the glass turntable. Do not rest other accessories on the support.

CRISP PLATE

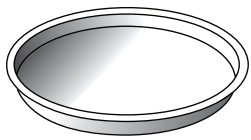

Only for use with the designated function. The Crisp plate must always be placed in the centre of the glass turntable and can be pre-heated when empty, using the special function for this purpose only. Place the food directly on the Crisp plate.

HANDLE FOR CRISP PLATE

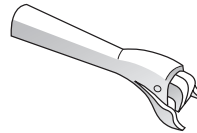

Useful for removing the hot Crisp plate from the oven.

WIRE RACK

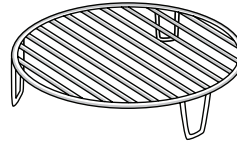

surfaces.

This allows you to place food closer to the grill, for perfectly browning your dish. Place the wire rack on the turntable, making sure that it does not come into contact with other

RECTANGULAR BAKING TRAY

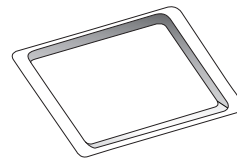

in the cooking compartment.

Only use the baking plate with functions that allow for convection cooking; it must never be used in combination with microwaves. Insert the plate horizontally, resting it on the rack

Please note: You do not need to remove the turntable and its support when using the rectangular baking plate.

The number and type of accessories may vary depending on which model is purchased. Other accessories that are not supplied can be purchased separately from the After-sales Service.

There are a number of accessories available on the market. Before you buy, ensure they are suitable for microwave use and resistant to oven temperatures.

Metallic containers for food or drink should never be used during microwave cooking.

Always ensure that foods and accessories do not come into contact with the inside walls of the oven.

Always ensure that the turntable is able to turn freely before starting the oven. Take care not to unseat the turntable whilst inserting or removing other accessories.

FUNCTIONS







6th SENSE FUNCTIONS

With the 6th Sense functions, simply select the type and weight or the quantity of the food items to obtain the best results. The oven will automatically calculate the optimum settings and continue to change them as cooking progresses.

The total time does not include preheating phases.





6th SENSE REHEAT

For reheating ready-made food that is either frozen or at room temperature. The oven automatically calculates the settings required to achieve the best results in the shortest amount of time. Place food on a microwave-safe and heatproof dinner plate or dish.

CATEGORY	FOOD	WEIGHT
	DINNER PLATE	250 - 500 g
	FROZEN PORTION	250 - 500 g
	FROZEN LASAGNA	250 - 500 g
	SOUPS	200 - 800 g
	BEVERAGES	1 - 5 dl

6th SENSE COOK

For cooking foods quickly and achieving optimal results. Use a heatproof container suitable for microwave use.

CATEGORY	FOOD	WEIGHT
	BAKED POTATOES (Turn when prompted)	200 g - 1 kg
	FRESH VEGETABLES (Cut into pieces of equal size and add 2 to 4 tablespoons of water. Cover)	200 - 800 g
	FROZEN VEGETABLES (Turn when prompted. Cover)	200 - 800 g
	CANNED VEGETABLES	200 - 600 g
	POPCORN	100 g

6th SENSE CRISP

For quickly reheating and cooking frozen foods and giving them a golden, crunchy top. Only use this function with the crisp plate provided. Turn the food when prompted.

CATEGORY	FOOD	WEIGHT
	FRENCH FRIES (Spread out in a single layer and sprinkle with salt before cooking)	200 - 600 g
	PIZZA, THIN CRUST	200 - 500 g
	PIZZA, THICK CRUST	300 - 800 g
	CHICKEN WINGS, CHICKEN PIECES (Lightly oil the plate)	200 - 600 g
	FISH FINGERS (Crisp plate must be preheated)	200 - 600 g

Required accessories: Crisp plate, handle for crisp plate

MICROWAVE

For quickly cooking and reheating food or drinks.

POWER	RECOMMENDED FOR
900 W	Quickly reheating drinks or other foods with a high water content
750 W	Cooking vegetables
650 W	Cooking meat and fish
500 W	Cooking meaty sauces, or sauces containing cheese or egg. Finishing off meat pies or pasta bakes
350 W	Slow, gently cooking. Perfect for melting butter or chocolate
160 W	Defrosting frozen foods or softening butter and cheese
90 W	Softening ice cream

FORCED AIR

For cooking dishes in a way that achieves similar results to using a conventional oven. The baking plate or other cookware that is suitable for oven use can be used to cook certain foods.

Recommended accessories: Rectangular baking plate, wire rack



CRISP

For perfectly browning a dish, both on the top and bottom of the food. This function must only be used with the special Crisp plate.

Required accessories: Crisp plate, handle for the Crisp plate



JET DEFROST

For quickly defrosting various different types of food simply by specifying their weight. Food should be placed directly on the glass turntable. Turn the food when prompted.

CATEGORY	FOOD	WEIGHT
	MEAT (mince, cutlets, steaks, roasting joints)	100 g - 2 kg
	POULTRY (whole chicken, pieces, fillets)	100 g - 2.5 kg
	FISH (whole, steaks, fillets)	100 g - 2 kg
	VEGETABLES (mixed vegetables, peas, broccoli etc.)	100 g - 2 kg
	BREAD (loaves, buns, rolls)	100 g - 1 kg



MANUAL FUNCTIONS



QUICK HEAT

For quickly reheating the oven before a cooking cycle. Wait for the function to finish before placing food inside the oven.



FORCED AIR + MICROWAVE

To prepare oven dishes in a short time.

Required accessories: wire rack



GRILL

For browning, grilling and gratins. We recommend turning the food during cooking. For best results, preheat the grill for 3-5 minutes.

Required accessories: wire rack



GRILL + MW

For quickly cooking and gratinating dishes, combining the microwave and grill functions.

Required accessories: wire rack



TURBO GRILL

For perfect results, combining the grill and convection oven functions. We recommend turning the food during cooking.

Required accessories: wire rack



TURBO GRILL + MW

For quickly cooking and browning your food, combining the microwave, grill and convection oven functions.

Required accessories: wire rack

FIRST TIME USE

. SETTING THE TIME

You will need to set the time when you switch on the oven for the first time.



The two digits for the hour will start flashing: Turn the knob to set the hour and then press to confirm.





The two digits for the minutes will start flashing. Turn the knob to set the minutes and press to confirm.

Please note: To change the time at a later point, press and hold for at least one second while the oven is off and repeat the steps above.

You may need to set the time again following lengthy power outages.

DAILY USE

1. SELECT A FUNCTION

When the oven is off, only the time is shown on the display. Press and hold  to switch the oven on. Turn the *knob* to view the main functions available on the left-hand display. Select one and press .



To select a sub-function (where available), select the main function and then press  to confirm and go to the function menu.

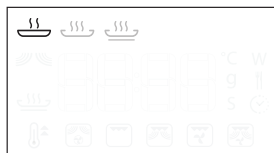

Turn the *knob* to select from amongst the subfunctions available on the right-hand display and then press .



2. SET A FUNCTION

. AUTOMATIC FUNCTIONS / JET DEFROST

FOOD CLASS

Once you have chosen one of the automatic functions, you will need to select a category for the food you are cooking.





When the  icon flashes, turn the *knob* to select the category you require and then press .

WEIGHT

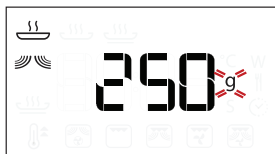
To achieve the best results, the automatic functions (and Jet Defrost) require you to enter the weight of the food, selecting from amongst the default settings: the oven will calculate the ideal length of time for the function to run for each category of food.



When the default setting appears on the display and the  icon flashes, turn the *knob* to set the weight and then press .

. MANUAL FUNCTIONS

After having selected the function you require, you can change its settings. The display will show the settings that can be changed in sequence.

MICROWAVE POWER / TEMPERATURE



When the **W** icon flashes on the display, turn the *knob* to adjust the power setting and then press  to confirm and continue to alter the settings that follow (if possible).

Please note: Once the function has been activated, the power can be changed by pressing  to access the settings menu, then turning the *knob* to change the setting.

GRILL POWER

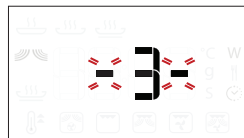

There are three defined power levels for grilling: 1 (low), 2 (mid), 3 (high). The default value is displayed between two flashing "-" symbols.



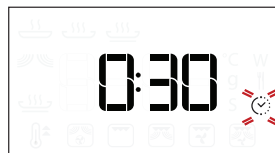

Turn the knob to set the desired grill level, then press  to confirm.

DURATION



When the  icon flashes on the display, use the *knob* to set the cooking time you require and then press  to confirm.

You do not have to set the cooking time if you want to manage cooking manually: Press  to confirm and start the function.

Note: During cooking, you can adjust the cooking time by turning the *knob*; each time you press , the cooking time increases by 30 seconds.

QUICK HEAT

Select the function, then use the *knob* to set the target temperature you require and press  to confirm and start the function.





When the oven reaches the target temperature a buzzer sound.

Please note: It is advisable to do not put the food into the oven before the end of this function.

3. ACTIVATE THE FUNCTION

Once you have applied the settings you require, press  to activate the function.

Every time the  button is pressed again, the cooking time will be increased by a further 30 seconds.

Please note: You can press  at any time to stop the function that is currently active.

. JET START

When the oven is switched off, it is possible to press  to activate cooking with the microwave function set at full power (900 W) for 30 seconds.

. SAFETY LOCK

This function is automatically activated to prevent the oven from being switched on accidentally.



Open and close the door, then press  to start the function.

4. PAUSE

To pause an active function, for example to stir or turn the food, simply open the door.

To start it up again, close the door and press .

AUTOMATIC PAUSE
(STIR OR TURN THE FOOD)

Certain functions will pause to allow you to turn or stir the food.



Once the oven has paused cooking, open the door and carry out the action you are prompted to perform before closing the door again and pressing  to continue with cooking.

5. COOKING END TIME

An audible signal will sound and the display will indicate that cooking is complete.



To extend the cooking time without changing the settings, turn the *knob* to set a new cooking time and press .

. COOLING DOWN

When a function with hot air is finished, the appliance may carry out a cooling procedure.

The display shows "Cool On".

After this procedure, the oven automatically switches off.

Please note: the cooling procedure can be interrupted by opening the door and will be eventually reactivated, if needs, by closing it again.

. KEY LOCK

To lock the keypad, press and hold  for at least 5 seconds.











































































Do this again to unlock the keypad.

Please note: The key lock can also be activated while cooking is in progress.









For safety reasons, the oven can be switched off at any time by pressing and holding .

COOKING TABLE

FOOD	FUNCTION	PREHEAT	TEMP. (°C)	POWER (W)	DURATION	ACCESSORIES
Leavened cakes		-	160 - 180	-	30 - 60	 
		-	160 - 180	90	25 - 50	 
Filled pies (cheesecake, strudel, apple tart)		Yes	160-190	-	35 - 70	 
Cookies		Yes	170-180	-	10 - 20	
Meringues		Yes	100-120	-	40 - 50	
Rolls		Yes	210-220	-	10 - 12	
Bread Loaf		Yes	180-200	-	30 - 35	
Pizza / Pie		Yes	190-220	-	20 - 40	
Pizza (0.4-0.5 Kg)		-	-	-	14 - 16	
Savoury pies (vegetable pie, quiche Lorraine)		Yes	180-190	-	40 - 55	 
Quiche lorraine (1-1.2 Kg)		-	-	-	18 - 20	
Lasagna / Baked pasta		-	-	350 - 500	15 - 40	 
Roast lamb / Veal / Roastbeef (1.3-1.5 Kg)		-	170-180	-	70 - 80*	 
		-	160-180	160	50 - 70*	 
Roastbeef - medium (1.3-1.5 Kg)		-	170-180	-	40 - 60*	 
Roast Chicken / Rabbit / Duck (whole 1-1.2 Kg)		-	210-220	-	50 - 70*	 
		-	210-220	350	45 - 60*	 
Chicken / Rabbit / Duck (fillets/pieces 0.4-1 Kg)		-	-	350 - 500	20 - 40*	 
		-	-	-	12 - 18	
Baked fish (whole)		-	-	160 - 350	20 - 40	 
Fish fillets / slices		Yes	-	-	15 - 30*	 
Stuffed vegetables (tomatoes, courgette, aubergines...)		-	-	500 - 650	25 - 50	 
Toast		-	-	-	3 - 6	
Sausages / Kebabs / Spare ribs / Hamburgers		-	-	-	20 - 40*	
Sausages / Hamburger (0.2-1 Kg)		Yes**	-	-	6 - 16	
Baked potatoes		-	-	350 - 500	20 - 40*	
Potatoes wedges (0.3-0.8 Kg)		-	-	-	10 - 20	
Baked fruit		-	-	160 - 350	15 - 25	 
Vegetable gratin		-	-	-	15 - 25	 
Fried vegetables (0.3-0.8 Kg)		Yes**	-	-	8 - 18	

* Turn the food halfway through cooking.

** Preheat the Crisp plate for 3-5 minutes.

FUNCTIONS	Crisp 	Forced air 	Forced air + MW 	Grill 	Grill + MW 
ACCESSORIES	Heatproof plate/container suitable for use in microwaves 	Wire rack 	Rectangular baking tray 	Crisp plate 	

CLEANING

Make sure that the appliance has cooled down before carrying out any maintenance or cleaning.
Do not use steam cleaners.

Do not use wire wool, abrasive scourers or abrasive/corrosive cleaning agents, as these could damage the surfaces of the appliance.

INTERIOR AND EXTERIOR SURFACES

- Clean the surfaces with a damp microfibre cloth. If they are very dirty, add a few drops of pH-neutral detergent. Finish off with a dry cloth.
- Clean the glass in the door with a suitable liquid detergent.
- At regular intervals, or in case of spills, remove the turntable and its support to clean the bottom of the oven, removing all food residue.
- The grill does not need to be cleaned as the intense heat burns away any dirt. Use this function on a regular basis.

ACCESSORIES

All accessories are dishwasher safe with the exception of the Crisp plate. The Crisp plate should be cleaned using water and a mild detergent. For stubborn dirt, rub gently with a cloth. Always leave the Crisp plate to cool down before cleaning.

TROUBLESHOOTING

Problem	Possible cause	Solution
The oven is not working.	Power cut. Disconnection from the mains.	Check for the presence of mains electrical power and whether the oven is connected to the electricity supply. Turn off the oven and restart it to see if the fault persists.
The oven makes noises, even when it is switched off.	Cooling fan active.	Open the door or hold  .
The display shows the letter "F" followed by a letter or number.	Software fault.	Contact your nearest After-sales Service Centre and state the letter or number that follows the letter "F".

PRODUCT FICHE

 [www](http://www.docs.whirlpool.eu) The product fiche with energy data of this appliance can be downloaded from the website docs.whirlpool.eu

HOW TO OBTAIN THE USE AND CARE GUIDE

>  [www](http://www.docs.whirlpool.eu) Download the Use and Care Guide from our website docs.whirlpool.eu (you can use this QR Code), specifying the product's commercial code.



> Alternatively, contact our Client After-sales Service

CONTACTING OUR AFTER-SALES SERVICE

You can find our contact details in the warranty manual. When contacting our Client After-sales Service, please state the codes provided on your product's identification plate.

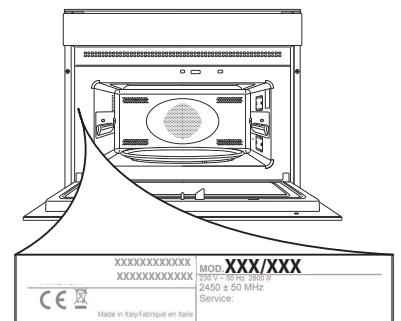

400011091756/B

Printed in Italy

يمكنك تنزيل تعليمات السلامة ودليل الاستخدام
والعناية من خلال زيارة موقعنا على الإنترنت
www.whirlpool.eu/docs واتباع التعليمات بظهور
الكتاب.

نشكرك على شرائك أحد منتجات شركة
WHIRLPOOL
للحصول على مزيد من المساعدة والدعم الشامل،
يرجى تسجيل منتجك على الموقع
www.whirlpool.eu/register



قبل استخدام الجهاز، احرص على قراءة دليل الصحة والأمان بعناية.



شرح المنتج

1. لوحة التحكم
2. عنصر التسخين الدائري
(غير مرئي)
3. لوحة التمييز
(لا تخلعها)
4. الباب
5. عنصر التسخين العلوي / الشواية
6. المصباح
7. القرص الدوار

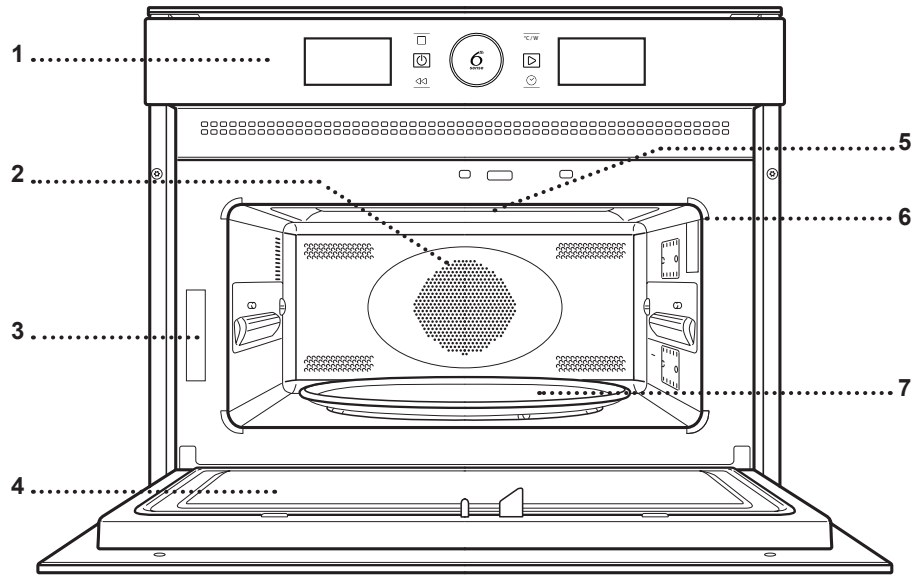

لوحة التحكم

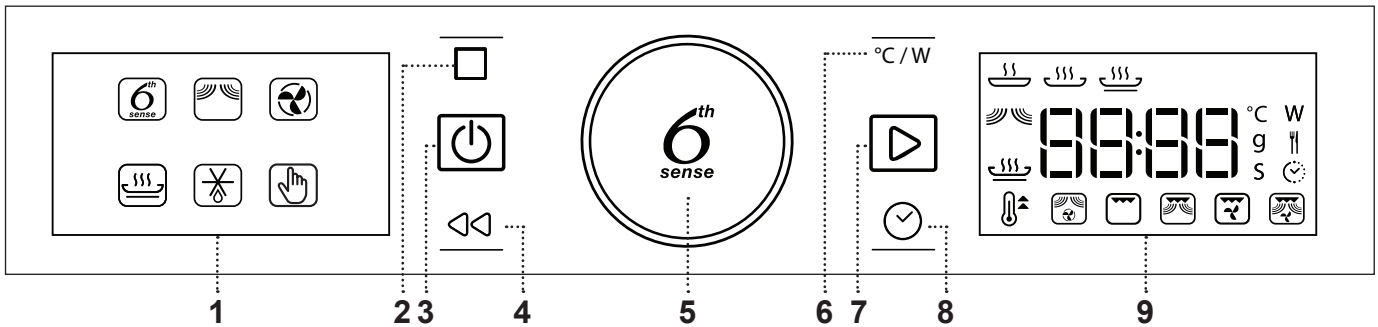

7. تشغيل
لتشغيل الوظائف وتأكيد الإعدادات
8. الوقت
لضبط الوقت وتغيير أو تعديل مدة الطهي.
9. الشاشة اليمنى

5. المفتاح الدوار / الزر 6th SENSE
أدره للتنقل عبر الوظائف وضبط جميع
بارامترات الطهي الأخرى. اضغط 
لاختيار وضبط والوصول إلى وتأكيد
الوظائف أو البارامترات وتشغيل برنامج
الطهي عند اللزوم.
6. القدرة
لضبط درجة الحرارة، مستوى الشواية أو
قدرة فرن الميكروويف.

1. الشاشة اليسرى
2. الإيقاف المؤقت
لإيقاف دورة الطهي مؤقتاً
3. تشغيل/إيقاف
لتشغيل أو إيقاف الفرن ولإيقاف إحدى
الوظائف الفعالة في أي وقت.
4. رجوع
للعودة إلى الشاشة السابقة.

مقبض صينية إعداد المقرمشات CRISP

يستخدم لإخراج صينية إعداد المقرمشات Crisp الساخنة من الفرن.

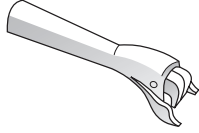

الشبكة السلكية

تتيح وضع الطعام قريباً من الشواية، لضمان التحمير المثالي للطعام. ضع الشبكة السلكية على القرص الدوار، مع التأكد من عدم ملامسته لأي أسطح أخرى.

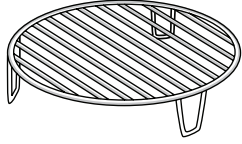

صينية الخبز المستطيلة

يستخدم لوح الخبز مع الوظائف التي تتيح الطهي بالتوزيع الحراري فقط، ولايستخدم بالاشتراك مع أجهزة الميكروويف أبداً. أدخل اللوح بشكل أفقي وضعه على الشبكة في حيز الطهي.

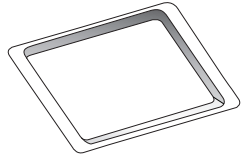

يرجى ملاحظة: لا يلزم خلع القرص الدوار ودعامته عند استخدام لوح الخبز المستطيل.

القرص الدوار

موضوع على دعامته، ويمكن استخدام القرص الدوار الزجاجي في جميع طرق الطهي.

كما يجب استخدام القرص الدوار دائماً كقاعدة للأواني والكماليات الأخرى، باستثناء صينية الخبز المستطيلة.

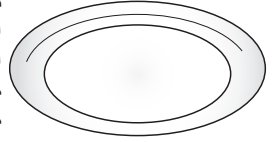

دعامة القرص الدوار

تستخدم الدعامة للقرص الدوار الزجاجي فقط. لا تضع أية كماليات أخرى على الدعامة.

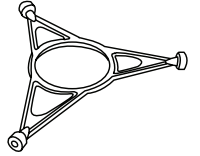

صينية إعداد المقرمشات CRISP

للاستخدام فقط مع الوظيفة المحددة. يجب وضع صينية إعداد المقرمشات Crisp دائماً في منتصف القرص الدوار الزجاجي، ويمكن إيمانها وهي فارغة، باستخدام الوظيفة المخصصة لهذا الغرض فقط. ضع الطعام مباشرة على صينية إعداد المقرمشات Crisp.

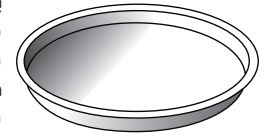

قد يختلف عدد ونوع الكماليات تبعاً للطراز الذي اشتريته. يمكن شراء الكماليات الأخرى غير الموردة بشكل منفصل من خدمة ما بعد البيع.

تأكد دائماً من عدم تلامس الأطعمة والكماليات مع جدران الفرن الداخلية.

تأكد دائماً من إمكانية تدوير القرص الدوار بحرية قبل تشغيل الفرن. يرجى مراعاة عدم خلع القرص الدوار أثناء إدخال أو إخراج الكماليات الأخرى.

يتوفر عدد من الكماليات في الأسواق. قبل الشراء، تأكد من أنها مناسبة للاستخدام مع الميكروويف ومقاومة لدرجات حرارة الفرن.

تجنب استخدام أواني الطعام أو الشراب المعدنية أثناء الطهي في الميكروويف.

وظيفة إعداد المقرمشات CRISP 6th SENSE

لإعادة تسخين وطهي الأطعمة المجمدة بسرعة ومنحها طبقة علوية ذهبية ومقرمشة. استخدم هذه الوظيفة مع صينية إعداد المقرمشات الموردة فقط. قم بتقليب الطعام عند طلب ذلك.

الوزن	الطعام	الفئة
200 - 600 جم	بطاطس محمرة (توزع في طبقة واحدة وتُرش بالملح قبل الطهي)	1*
200 - 500 جم	بيتزا، قشرة رقيقة	2*
300 - 800 جم	بيتزا، قشرة سميكة	3*
200 - 600 جم	أجنحة دجاج، قطع دجاج (ادهن اللوح بقليل من الزيت)	4*
200 - 600 جم	أصابع السمك (يجب تسخين صينية إعداد المقرمشات CRISP مسبقاً)	5*

الكماليات المطلوبة: صينية إعداد المقرمشات CRISP، مقبض صينية إعداد المقرمشات CRISP

ميكروويف

لطهي الأطعمة والمشروبات وإعادة تسخينها بسرعة.

القدرة	ملانم لـ
900 واط	إعادة التسخين السريع للمشروبات والأطعمة المحتوية على نسبة ماء عالية
750 واط	طبخ الخضروات
650 واط	طهي اللحوم والأسماك
500 واط	طهي صوص اللحوم، أو الصوص المحتوي على جبن أو بيض. إنهاء فطائر اللحوم والمعكرونة الفرن
350 واط	الطهي ببطء ورفق. مثالي لصهر الزبد أو الشيكولاتة
160 واط	إذابة تجمد الأطعمة المجمدة، تليين الزبد والجبن
90 واط	تليين الأيس كريم

وظيفة دفع الهواء

لتحضير الأطباق بطريقة تعطي نفس نتائج استخدام الفرن التقليدي. يمكن استخدام صينية الخبيز أو أواني الطهي الأخرى الملائمة للاستخدام داخل الفرن لطهي أنواع معينة من الأطعمة.

الكماليات الموصى بها: لوح الخبيز المستطيل، الشبكة السلكية

وظائف 6th SENSE



من خلال الوظائف 6th Sense ما عليك سوى اختبار نوع ووزن أو كمية الطعام لتحقيق أفضل النتائج. سيقوم الفرن أوتوماتيكياً بحساب الإعدادات المثلى مع الاستمرار في تغييرها أثناء عملية الطهي. مراحل الإحماء لا تدخل ضمن المدة الإجمالية.

وظيفة إعادة التسخين 6th SENSE

لإعادة تسخين الوجبات الجاهزة المجمدة أو الباردة أو في درجة حرارة الغرفة. حيث يقوم الفرن أوتوماتيكياً بضبط الإعدادات اللازمة لتحقيق أفضل نتائج ممكنة في أقصر مدة زمنية. ضع الطعام على صينية أو طبق آمن للاستخدام في الميكروويف ومقاوم للحرارة.

الوزن	الطعام	الفئة
250 - 500 جم	صينية عشاء	1
250 - 500 جم	كمية مجمدة	2*
250 - 500 جم	لازانيا مجمدة	3*
200 - 800 جم	حساء	4
1 - دسيليتر	المشروبات	5

وظيفة الطهي 6th SENSE

لطهي الأطعمة بسرعة والحصول على نتائج ممتازة. استخدم إناء مقاوم للحرارة ومناسب للاستخدام في الميكروويف.

الوزن	الطعام	الفئة
200 جم - 1 كجم	بطاطس فرن (تقليب عند الطلب)	1
200 - 800 جم	خضروات طازجة (يتم التقطيع إلى قطع متساوية في الحجم وإضافة ملعقتين أو أربع ملاعق ماء. الغطاء)	2
200 - 800 جم	الخضروات المجمدة (تقليب عند الطلب. الغطاء)	3*
200 - 600 جم	خضروات معلبة	4
100 جم	فشار	5

الوظائف اليدوية



التسخين السريع



لإعادة تسخين الفرن بسرعة قبل دورة الطهي. انتظر حتى انتهاء الوظيفة قبل وضع الطعام داخل الفرن.

دفع الهواء + الميكروويف



لتحضير وجبات الفرن في فترة قصيرة.

الكماليات المطلوبة: الشبكة السلكية

وظيفة الشواية



للتحمير، الشواء وعمل الغراتان. نوصي بتقليب الطعام أثناء الطهي. لتحقيق أفضل النتائج، قم بإحماء الشواية لمدة 5-3 دقائق.

الكماليات المطلوبة: الشبكة السلكية

شواية + ميكروويف



لطهي الأطعمة وتحميرها بسرعة من خلال الدمج بين وظائف الميكروويف والشواية.

الكماليات المطلوبة: الشبكة السلكية

الشواية التريبو



لتحقيق نتائج مثالية من خلال الدمج بين وظائف الشواية وفرن التوزيع الحراري. نوصي بتقليب الطعام أثناء الطهي.

الكماليات المطلوبة: الشبكة السلكية

الشواية التريبو + الميكروويف



لطهي الأطعمة وتحميرها بسرعة من خلال الدمج بين وظائف الميكروويف والشواية والتوزيع الحراري.

الكماليات المطلوبة: الشبكة السلكية

CRISP



لتحمير الطعام بشكل مثالي سواء من الأعلى أو الأسفل. يجب استخدام هذه الوظيفة مع صينية إعداد المقرمشات Crisp فقط.

الكماليات المطلوبة: صينية إعداد المقرمشات CRISP، مقبض صينية إعداد المقرمشات CRISP

الإذابة السريعة للتجمد JET DEFROST



لإذابة التجمد عن الأنواع المختلفة من الأطعمة بسهولة من خلال تحديد وزنها. ينبغي وضع الطعام مباشرة على القرص الدوار الزجاجي. قم بتقليب الطعام عند طلب ذلك.

الوزن	الطعام	الفئة
100 جم - 2 كجم	اللحوم (لحم مفروم، لحم الضلع، شرائح، قطع لحم الروست)	1*
100 جم - 5.2 كجم	الطيور (دجاجة كاملة، قطع أو شرائح فيليه)	2*
100 جم - 2 كجم	الأسماك (سمكة كاملة أو شرائح أو فيليه)	3*
100 جم - 2 كجم	الخضروات (خضروات مشكلة ويقولييات وبروكلي، وخلافه)	4*
100 جم - 1 كجم	الخبز (أرغفة، كيزر، لفائف)	5*

الاستخدام لأول مرة

ضبط الوقت

يلزم ضبط الوقت عند تشغيل الفرن لأول مرة.



ثم يبدأ رقما الساعة في الوميض: أدر المفتاح لضبط الساعات واضغط على للتأكيد.



ثم يبدأ رقما الدقائق في الوميض. أدر المفتاح لضبط الدقائق واضغط على للتأكيد.

يرجى ملاحظة: لتغيير الوقت في وقت لاحق، اضغط واستمر في الضغط على لأقل من ثانية واحدة بينما الفرن متوقف وكرر الخطوات السابقة.

قد يلزم ضبط الوقت مرة أخرى في حالة انقطاع الكهرباء لفترة طويلة.

الوظائف اليدوية

بعد اختيار الوظيفة المطلوبة، يمكنك تغيير إعداداتها. سوف يظهر بوحدة العرض الإعدادات التي يمكن تغييرها بالترتيب. قدرة فرن الميكرويفيف / درجة الحرارة



عندما تومض الأيقونة W على شاشة العرض، أدر المفتاح لتعديل الضبط ثم اضغط على للتأكيد واستمر في تغيير الإعدادات التالية (إن أمكن).

يرجى ملاحظة: عند تفعيل الوظيفة، يمكن تغيير الطاقة بالضغط على للوصول إلى قائمة الإعدادات، ثم إدارة المفتاح لتغيير الإعداد.

طاقة الشواية

هناك ثلاثة مستويات قدرة محددة للشواء: 1 (منخفض)، 2 (متوسط)، 3 (عالي). تظهر بالشاشة القيمة الافتراضية بين الرمزين الوماضين "-".



أدر المفتاح لضبط مستوى الشواء المرغوب، ثم اضغط على للتأكيد.

المدة



عندما تومض الأيقونة على وحدة العرض، استخدم المفتاح لضبط مدة الطهي المرغوبة، ثم اضغط على للتأكيد.

لا يلزمك إعداد مدة الطهي إذا كنت ترغب في إدارة الطهي يدوياً: اضغط على للتأكيد وأبدأ تشغيل الوظيفة.

ملاحظة: أثناء الطهي يمكنك تعديل زمن الطهي بإدارة المفتاح، تؤدي كل ضغطة على إلى زيادة مدة الطهي بمقدار 30 ثانية.

وظيفة إعادة التسخين السريع

اختر الوظيفة، ثم استخدم المفتاح لضبط درجة الحرارة التي تريدها واضغط على للتأكيد وقم بتشغيل الوظيفة.



عندما يصل الفرن إلى درجة الحرارة المستهدفة، يصدر صوت صافرة.

يرجى ملاحظة: ينصح بعدم وضع الطعام في الفرن قبل انتهاء هذه الوظيفة.

1. اختيار وظيفة

عندما يكون الفرن متوقفاً، يظهر الوقت فقط على وحدة العرض. اضغط واستمر في الضغط على لتشغيل الفرن. أدر المفتاح لعرض الوظائف الرئيسية المتاحة على الشاشة اليسرى. اختر واحدة منها ثم اضغط على .



لاختيار وظيفة فرعية (إذا توفر)، اختر الوظيفة الرئيسية ثم اضغط على للتأكيد ثم انتقل إلى قائمة الوظيفة.



أدر المفتاح للاختيار من بين الوظائف الفرعية المتاحة على الشاشة اليمنى ثم اضغط على للتأكيد.

2. إعداد وظيفة

الوظائف الأوتوماتيكية / JET DEFROST

فئة الطعام

عند اختيار إحدى الوظائف الأوتوماتيكية، ستحتاج إلى اختيار فئة الطعام المرغوب طهيها.



عندما تومض الأيقونة أدر المفتاح لاختيار الفئة المرغوبة ثم اضغط على للتأكيد.

الوزن

وللحصول على نتائج طهي مثالية، فإن الوظائف الأوتوماتيكية (وإذابة التجمد السريع) تتطلب منك إدخال وزن الطعام، بالاختيار من بين الإعدادات الافتراضية: وسيقوم الفرن بحساب المدة المثالية للوظيفة للعمل مع كل فئة طعام.



عندما يظهر الإعداد الافتراضي على وحدة العرض وتومض الأيقونة ، أدر المفتاح لضبط الوزن ثم اضغط على للتأكيد.

3. تفعيل الوظيفة

وبمجرد تطبيق كافة الإعدادات المرغوبة، اضغط على [] لتفعيل الوظيفة.

في كل مرة يتم فيها إعادة الضغط على الزر [] تزداد مدة الطهي 30 ثانية أخرى.

يرجى ملاحظة: يمكنك الضغط على [] في أي وقت لإيقاف الوظيفة المفعلة حالياً.

JET START .

عندما يتوقف الفرن، يمكن الضغط على [] لتفعيل الطهي بوظيفة الميكروويف المضبوطة على القدرة الكاملة (900 واط) لمدة 30 ثانية.

. قفل الأمان

يتم تفعيل هذه الوظيفة أوتوماتيكياً لمنع تشغيل الفرن بدون قصد.

door

افتح الباب وأغلقه ثم اضغط على [] لبدء تشغيل الوظيفة.

4. إيقاف المؤقت

لإيقاف الوظيفة الفعالة مؤقتاً، على سبيل المثال لقلب أو لتقليب الطعام، ما عليك سوى فتح الباب.

ولإعادة التشغيل، أغلق الباب واضغط على [].

الإيقاف المؤقت الأوتوماتيكي (قم بتقليب أو قلب الطعام)

تتوقف بعض الوظائف مؤقتاً ليتسنى لك فرصة تقليب أو قلب الطعام.

turn

فور توقف الفرن مؤقتاً عن الطهي، افتح الباب واتخذ الإجراء المطلوب منك قبل غلق الباب مرة أخرى والضغط على [].
لمواصلة الطهي.

5. زمن انتهاء الطهي

وستصدر إشارة صوتية وتشير وحدة العرض إلى اكتمال الطهي.



لإطالة مدة الطهي دون تغيير الإعدادات، أدر المفتاح لضبط مدة طهي جديدة واضغط على [].

. قيد التبريد

بعد انتهاء عمل وظيفة الهواء الساخن قد يقوم الجهاز بعملية تبريد.

تظهر في وحدة العرض الرسالة "Cool On" (التبريد مشغل). وبعد إجراء هذه العملية يتوقف الفرن أوتوماتيكياً.

يرجى ملاحظة: من الممكن إيقاف عملية التبريد من خلال فتح الباب وقد يتم إعادة تفعيلها، عند اللزوم، بإغلاق الباب مرة أخرى.

. قفل المفاتيح

لقفل لوحة المفاتيح، اضغط واستمر في الضغط على [] لمدة 5 ثواني على الأقل.

0 - - n

قم بذلك مرة أخرى لإلغاء قفل لوحة المفاتيح.

يرجى ملاحظة: يمكن تفعيل وظيفة قفل المفاتيح أثناء الطهي. لدواعي السلامة، يمكن إيقاف الفرن في أي وقت باستمرار الضغط على الزر [].

الكماليات	المدّة	القدرة (واط)	درجة الحرارة (م°)	الإحماء	الوظيفة	الطعام
	60 - 30	-	180 - 160	-		كيك مخمر
	50 - 25	90	180 - 160	-		الفطائر المحشوة (تشيز كيك، فطيرة محشوة، فطيرة تفاح)
	70 - 35	-	190-160	نعم		كعك صغير
	20 - 10	-	180-170	نعم		الميرننجز
	50 - 40	-	120-100	نعم		رولز
	12 - 10	-	220-210	نعم		رغيف خبز
	35 - 30	-	200-180	نعم		بيتزا / فطير
	40 - 20	-	220-190	نعم		بيتزا (5.0-4.0 كجم)
	16 - 14	-	-	-		الفطائر المتبلّة (فطيرة الخضروات، فطيرة كيش لورين)
	55 - 40	-	190-180	نعم		فطيرة كيش لورين (2.1-1 كجم)
	20 - 18	-	-	-		لازانيا / معكرونة فرن
	40 - 15	500 - 350	-	-		لحم ضأن مشوي / لحم بتلو / لحم بقري (5.1-3.1 كجم)
	*80 - 70	-	180-170	-		لحم بقري - متوسط (5.1-3.1 كجم)
	*70 - 50	160	180-160	-		دجاج مشوي / لحم أرانب / بط (كاملة 2.1-1 كجم)
	*60 - 40	-	180-170	-		دجاج / أرانب / بط (فيليه / قطع 1-4.0 كجم)
	*70 - 50	-	220-210	-		سمكة مشوية (كاملة)
	*60 - 45	350	220-210	-		سمك فيليه/شرانج
	*40 - 20	500 - 350	-	-		خضروات محشوة (طماطم، كوسة، باذنجان...)
	18 - 12	-	-	-		التوست
	40 - 20	350 - 160	-	-		السجق/الكباب/قطع لحم الضلوع "الريش"/شطانر البيف برجر
	*30 - 15	-	-	نعم**		سجق / برجر (1-2.0 كجم)
	50 - 25	650 - 500	-	-		بطاطس محمصة
	6 - 3	-	-	-		بطاطس ودرج (8.0-3.0 كجم)
	*40 - 20	-	-	-		فاكهة مخبوزة
	16 - 6	-	-	-		جراتان الخضروات
	*40 - 20	500 - 350	-	-		خضروات مقلية (8.0-3.0 كجم)
	20 - 10	-	-	-		
	25 - 15	350 - 160	-	-		
	25 - 15	-	-	-		
	18 - 8	-	-	نعم**		

** قم بإحماء صينية إعداد المقرمشات لمدة 3-5 دقائق.

* اقلب الطعام في منتصف دورة الطهي.

الوظائف	Crisp	وظيفة دفع الهواء	وظيفة دفع الهواء + الميكروويف	الشواية	شواية + ميكروويف
الكماليات	إثناء/طبق مقاوم للحرارة مناسب للاستخدام في الفرن	شبكة سلكية	صينية الخبز المستطيلة	لوح إعداد المقرمشات Crisp	

تأكد أن الجهاز بارد تماما قبل القيام بأية أعمال متعلقة بالصيانة أو التنظيف.

لا تستخدم أبدا أجهزة تنظيف بالبخار.

لا تستخدم ألياف سلكية، مساحيق كاشطة أو منظفات مزيلة/أكالة، لأنها قد تعرض أسطح الجهاز للضرر.

الأسطح الداخلية والخارجية

- قم بتنظيف الأسطح بقطعة قماش دقيقة الألياف رطبة. إذا كانت الأسطح شديدة الاتساخ، فأضف بضع قطرات من منظف محايد إلى الماء. وجففها في النهاية باستخدام قطعة قماش جافة.
- قم بتنظيف زجاج الباب باستخدام منظف سائل ملائم.
- قم في مواعيد منتظمة، خاصة في حالة وجود آثار انسكاب، بإخراج القرص الدوار ودعامته لتنظيف قاعدة الفرن من بقايا الطعام.
- لا تحتاج الشواية إلى تنظيف نظراً لقيام الحرارة الشديدة بحرق أية اتساخات. استخدم هذه الوظيفة على فترات منتظمة.

الكماليات

جميع الكماليات آمنة للغسيل في غسالة الأطباق باستثناء صينية إعداد المقرمشات Crisp. ينبغي تنظيف صينية إعداد المقرمشات Crisp باستخدام ماء ومنظف متعادل. للتخلص من البقع العنيدة، فقم بحكها برفق باستخدام قطعة قماش. اترك دائماً صينية إعداد المقرمشات Crisp تبرد قبل التنظيف.

دليل تحري الأعطال

المشكلة	السبب المحتمل	الحل
الفرن لا يعمل.	انقطاع التيار الكهربائي. الفصل من الشبكة الكهربائية.	تحقق من وجود تيار كهربائي بالشبكة الكهربائية ومن توصيل الفرن بمصدر الكهرباء. أوقف الفرن، ثم أعد تشغيله للتحقق مما إذا كان العطل لا يزال قائماً.
الفرن يحدث ضجيجا رغم أنه متوقف.	مروحة التبريد فعالة.	افتح الباب أو ثب الزر  .
وحدة العرض تعرض الحرف "F" متبوعاً بحرف أو رقم.	خلل ببرمجيات الجهاز.	اتصل بأقرب مركز لخدمة ما بعد البيع واذكر الرقم التابع لحرف "F".

كتيب المنتج

[www](http://www.whirlpool.com) يمكنك تنزيل كتيب المنتج الخاص بهذا الجهاز شاملاً معدلات كفاءة استهلاك الطاقة عبر موقعنا على الإنترنت docs.whirlpool.eu

كيفية الحصول على دليل الاستخدام والعناية

< [www](http://www.whirlpool.com) قم بتنزيل دليل الاستخدام والعناية من موقعنا على الإنترنت docs.whirlpool.eu (يمكنك استخدام رمز الاستجابة السريع QR هذا)، مع تحديد الرمز التجاري للمنتج.

< وكحل بديل، اتصل بخدمة ما بعد البيع لدينا



الاتصال بخدمة ما بعد البيع لدينا

يمكنك الاطلاع على تفاصيل الاتصال بنا في كتيب الضمان. يرجى عند الاتصال بخدمة ما بعد البيع ذكر الأكواد المذكورة على لوحة تمييز المنتج.

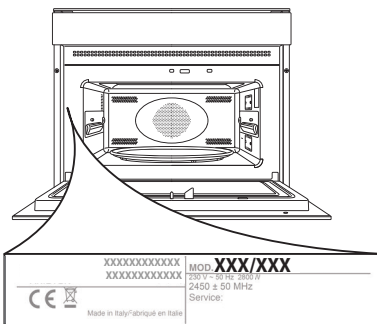

400011091756/B

Printed in Italy

DAGLIG BRUGERVEJLEDNING



TAK FORDI DU HAR KØBT ET WHIRLPOOL PRODUKT

Med henblik på at modtage en omfattende service og support, bedes du registrere dit produkt på www.whirlpool.eu/register



Du kan downloade Sikkerheds- og Brugs- og vedligeholdelsesvejledningen ved at gå ind på vores website docs.whirlpool.eu og følge anvisningerne på bagsiden af dette hæfte.



Læs Sundheds- og sikkerhedsvejledningen grundigt, før apparatet tages i brug.

PRODUKTBEKRIVELSE

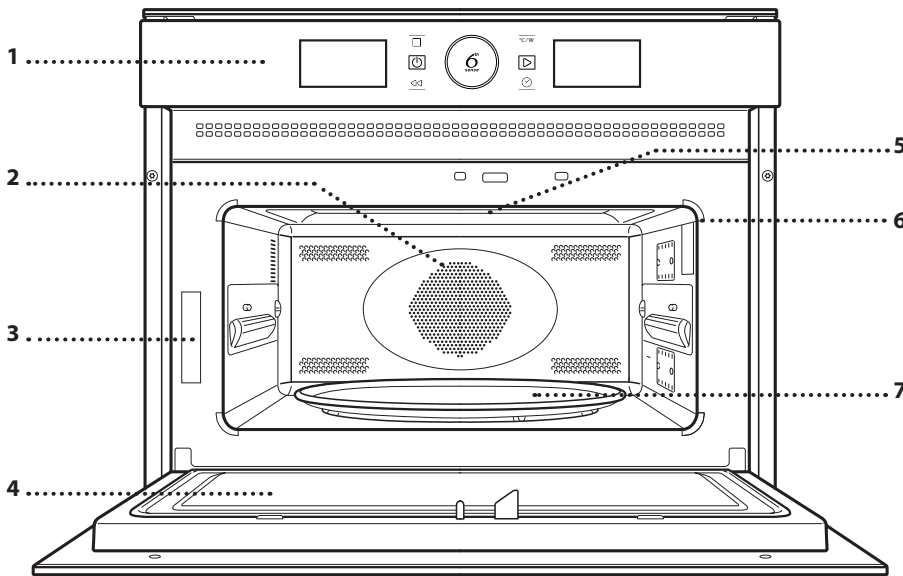

1. Betjeningspanel
2. Ringvarmelegeme (ikke synligt)
3. Identifikationsskilt (må ikke fjernes)
4. Ovnlåge
5. Øverste varmelegeme/grill
6. Lys
7. Drejetallerken

BETJENINGSPANEL

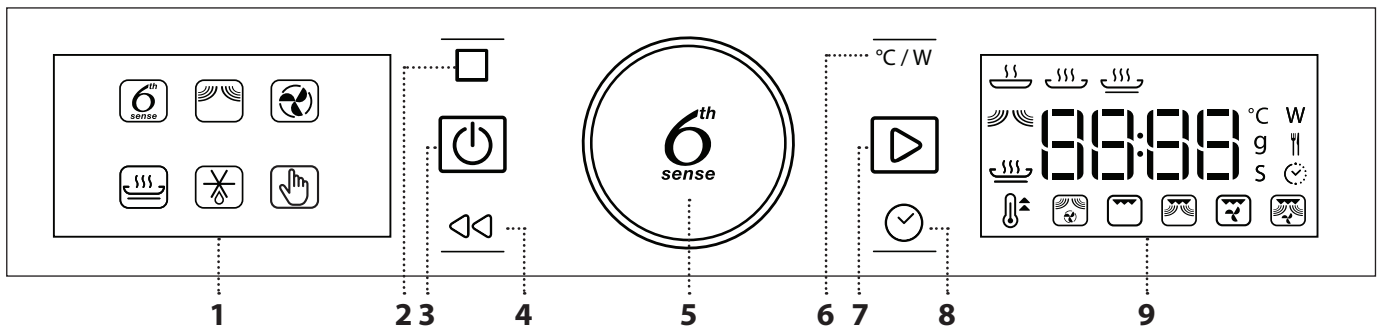

1. VENSTRE DISPLAY

2. PAUSE

Til midlertidig standsning af en tilberedningscyklus

3. ON/OFF

Bruges til at tænde og slukke for ovnen og når som helst stoppe en aktiv funktion.

4. TILBAGE

Bruges til at vende tilbage til det forrige skærbillede.

5. DREJEKNAP / KNAPPEN 6th SENSE

Drej herpå, for at browse gennem funktionerne og justere alle tilberedningsparametrene.

Tryk på  for at markere, indstille, tage adgang til eller bekræfte funktioner eller parametre, samt eventuelt starte tilberedningsprogrammet.

6. EFFEKT

Til justering af temperatur, grillstyrke eller mikrobølgeeffekt.

7. START

Bruges til at starte funktioner og bekræfte indstillinger

8. KLOKESLÆT

Bruges til at indstille klokkeslættet og til at ændre eller justere tilberedningstiden.

9. HØJRE DISPLAY

TILBEHØR

DREJETALLERKEN

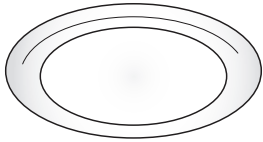

Drejetallerkenen kan bruges med alle tilberedningsmetoder, når den placeres på den tilhørende støtte.

Drejetallerkenen skal altid bruges som underdel for andre

beholdere eller tilbehør, med undtagelse af den rektangulære bageplade.

DREJEKRYDS

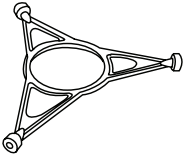

Brug kun drejekrydset til glasdrejetallerkenen. Andet tilbehør må ikke hvile på drejekrydset.

CRISPPANDE

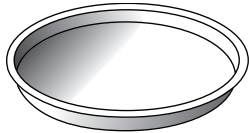

Må kun anvendes med den forudsete funktion.

Crisp-panden skal altid placeres på midten af glasdrejetallerkenen, og kan forvarmes, når den er tom ved

brug af den dertil beregnede specialfunktion. Anbring maden direkte på Crisp-panden.

HÅNDTAG TIL CRISP-PANDE

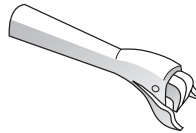

Nyttig til at tage den varme Crisp-pande ud af ovnen.

RIST

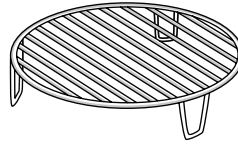

Man får herved mulighed for at anbringe maden tættere på grillen og brune retten perfekt. Anbring risten på drejetallerkenen, og sørg for, at den ikke berører andre

overflader.

REKTANGULÆR BAGEPLADE

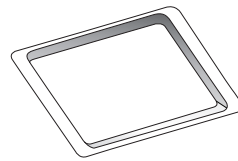

Bagepladen må kun bruges til funktioner, der giver mulighed for varmluftsbagning; den må aldrig anvendes i kombination med mikrobølger. Indsæt pladen i vandret stilling,

og lad den hvile på hylden i ovnrummet.

Bemærk: Du behøver ikke tage drejetallerkenen og dens støtter ud, når du bruger den rektangulære bageplade.

Antallet og typerne af tilbehør kan variere afhængigt af, hvilken model der er købt. Yderligere, ikke medfølgende, tilbehør kan købes separat hos Kundeservice.

Der er et stort udvalg af tilbehør på markedet. Før indkøb skal du sikre dig, at det er velegnet til brug i mikrobølgeovn og, at det er ildfast til brug i ovnen.

Der må aldrig bruges metalbeholdere til mad- eller drikkevarer under tilberedning i mikrobølgeovn.

Sørg altid for, at mad og tilbehør ikke kommer i kontakt med ovnens indersider.

Inden der tændes for ovnen, skal man altid sikre sig, at drejetallerkenen kan dreje frit. Vær opmærksom på ikke at vælte drejetallerkenen, når du indsætter eller fjerner andet tilbehør.

FUNKTIONER







6th SENSE FUNKTIONER

Med 6th Sense funktionerne skal man blot vælge fødevarens type og vægt eller mængde, for at opnå de bedste resultater. Ovnen vil automatisk beregne de optimale indstillinger og fortsat ændre dem mens tilberedningen skrider frem. Den samlede tid inkluderer ikke forvarmingsfaser.

6th SENSE OPVARMN.

Bruges til at genvarme en færdiglavet ret, som er frosset eller ved rumtemperatur. Ovnen beregner automatisk de indstillinger, der kræves for at opnå de bedst mulige resultater, på så kort tid som muligt. Anbring retten på en ovn- og mikrobølgefast tallerken eller fad.

GRUPPE	MADVARER	VÆGT
 	MIDDAGSTALLERKEN	250 - 500 g
 	FROSSEN PORTION	250 - 500 g
 	FROSSEN LASAGNE	250 - 500 g
 	SUPPER	200 - 800 g
 	DRIKKEVARER	1 - 5 dl

6th SENSE TILBEREDNING

Til hurtig tilberedning af ovnretter og opnå optimale resultater. Brug et ildfast fad/beholder, som egner sig til mikrobølgeovne.

GRUPPE	MADVARER	VÆGT
 	BAGTE KARTOFLER (Drej på opfordring)	200 g - 1 kg
 	FRISKE GRØNSAGER (Skær i ensartede stykker og tilsæt 2 til 4 spsk. vand. Dæk til)	200 - 800 g
 	FROSNE GRØNSAGER (Vend på opfordring. Dæk til)	200 - 800 g
 	GRØNTSAGER PÅ DÅSE	200 - 600 g
 	POPCORN	100 g

6th SENSE CRISP

Bruges til hurtig opvarmning og tilberedning af frosne madvarer og til at give dem gylden og sprød top. Brug kun denne funktion med den medfølgende Crisp-pande. Vend maden når dette forespørges.

GRUPPE	MADVARER	VÆGT
 	POMME FRITES (læg dem i ét lag og drys dem med salt før tilberedningen)	200 - 600 g
 	PIZZA, TYND BUND	200 - 500 g
 	PIZZA, TYK BUND	300 - 800 g
 	KYLLINGEVINGER, KYLINGESTYKKER (Smør med en smule olie)	200 - 600 g
 	FISKEPINDE (Crisp-panden skal forvarmes)	200 - 600 g

Krævede tilbehør: Crisp-pande, håndtag til Crisp-pande

MIKROBØLGE

Bruges til hurtig tilberedning og genopvarme mad- eller drikkevarer.

EFFEKT	ANBEFALET TIL
900 W	Hurtig genopvarmning af drikkevarer eller madvarer med højt vandindhold
750 W	Tilberedning af grøntsager
650 W	Tilberedning af kød og fisk
500 W	Tilberedning af kødsovs eller sovs med ost eller æg. Færdiggørelse af kødpostej eller indbagt pasta
350 W	Langtidsstegning. Perfekt til at smelte smør eller chokolade
160 W	Optøning af frosne madvarer eller blødgøring af smør og ost
90 W	Blødgøring af is

VARMLUFT

Bruges til at tilberede retter på en måde, der sikrer lignende resultater som ved brug af en konventionel ovn. Bagepladen eller andet køkkengrej, som egner sig til at bruges i ovnen, kan anvendes til at tilberede visse retter.

Anbefalet tilbehør: Rektangulær bageplade/rist



CRISP

Bruges til at brune en ret på perfekt måde, både rettens top og bund. Denne funktion må kun bruges med den specielle Crisp-pande.

Krævede tilbehør: Crisp-pande, håndtag til Crisp-pande



JET DEFROST

Til hurtig optøning af forskellige typer af mad ved blot at angive deres vægt. Maden skal anbringes direkte på glasdrejetallerkenen. Vend maden når dette forespørges.

GRUPPE	MADVARER	VÆGT
	KØD (hakkekød, koteletter, bøfkød, stege)	100 g - 2 kg
	FJERKRÆ (hel kylling, parteret eller fileter)	100 g - 2,5 kg
	FISK (hel, bøffer, fileter)	100 g - 2 kg
	GRØNSAGER (blandede grøntsager, ærter, broccoli, osv.)	100 g - 2 kg
	BRØD (franskbrød, rundstykker, boller)	100 g - 1 kg



MANUELLE FUNKTIONER



LYNOPVARMNING

Bruges til hurtigt at opvarme ovnen inden en tilberedningscyklus. Vent til funktionen er færdig, før der sættes mad i ovnen.



VARMLUFT + MIKRO.

Bruges til hurtigt at tilberede ovnretter.

Krævede tilbehør: Rist



GRILL

Bruges til at brune, grille og gratinere. Vi anbefaler at vende maden under tilberedningen. Forvarm grillen i 3-5 minutter for de bedste resultater.

Krævede tilbehør: Rist



GRILL + MIKROBØLGER

Bruges til hurtigt at tilberede og gratinere retter ved at kombinere mikrobølge- og grillfunktionerne.

Krævede tilbehør: Rist



TURBO GRILL

Kombinering af grill- og varmlufts-bagningsfunktioner for de bedste resultater. Vi anbefaler at vende maden under tilberedningen.

Krævede tilbehør: Rist



TURBO GRILL + MIKRO

Til hurtig tilberedning og brunning af din mad ved at kombinere mikrobølge-, grill- og varmlufts-funktioner.

Krævede tilbehør: Rist

FØRSTEGANGSBRUG

. INDSTILLING AF KLOKKESLÆT

Det er nødvendigt, at indstille klokkeslættet første gang, man tænder for apparatet.



Timernes to cifre begynder at blinke: Drej på *knappen*, for at indstille timetallet, og tryk herefter på , for at bekræfte.

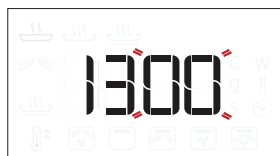



Minutternes to cifre begynder at blinke. Drej på *knappen*, for at indstille minuttallet, og tryk på , for at bekræfte.

Bemærk: Tryk og hold  trykket i mindst et sekund, mens ovnen er slukket, og gentag de ovenstående handlinger, hvis du vil ændre klokkeslættet på et senere tidspunkt.

Du skal muligvis indstille klokkeslættet igen efter længerevarende strømafbrydelser.

DAGLIG BRUG

1. VÆLG EN FUNKTION

Når ovnen er slukket vises kun klokkeslættet på displayet. Tryk og hold  trykket, for at tænde for ovnen. Drej på *knappen*, for at se de disponible funktioner på displayet til venstre. Markér en og tryk på .

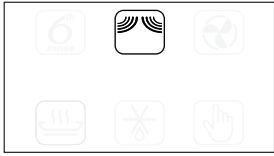

Man kan vælge en underfunktion (om forudsat), ved at vælge hovedfunktionen og herefter trykke på , for at bekræfte og fortsætte til funktionsmenuen.





Drej på *knappen*, for at vælge underfunktionerne blandt de disponible på displayet til højre, og tryk herefter på , for at bekræfte.

2. INDSTILLING AF EN FUNKTION

. AUTOMATISKE FUNKTIONER / JET DEFROST MADKATEGORI

Når du har valgt en af de automatiske funktioner, skal du vælge en kategori til madvaren, der skal tilberedes.





Når ikonet  blinker skal man dreje på *knappen*, for at vælge den ønskede kategori, og herefter trykke på , for at bekræfte.

VÆGT

Med henblik på at opnå de bedste resultater, kræver de automatiske funktioner (og Jet Defrost), at man indtaster vægten på fødevaren, der skal vælges blandt standardindstillingerne: Ovnen vil beregne den ideelle varighed for funktionen for de forskellige fødevarer kategorier.



Når standardindstillingen visualiseres på displayet og ikonet  blinker, skal man dreje på *knappen*, for at indstille vægten, og herefter trykke på , for at bekræfte.

. MANUELLE FUNKTIONER

Man kan ændre funktionens indstillinger efter at have markeret den. Displayet vil vise de indstillinger, som kan ændres, i rækkefølge.

MIKROBØLGEEFFEKT / TEMPERATUR



Drej, når ikonet the **W** blinker på displayet, på *knappen* for at justere effektindstillingen og tryk herefter på , for at bekræfte og fortsætte til den næste indstilling, der skal ændres (om muligt).

Bemærk: Efter aktivering af funktionen kan effekten ændres ved at trykke på , for at tage adgang til indstillingsmenuen, og herefter dreje på *knappen*, for at ændre indstillingen.

GRILLEFFEKT

er der tre definerede effekt niveauer til grillstegning: 1 (lav), 2 (mid), 3 (høj). Defaultværdien visualiseres mellem to "-" symboler.



Drej på *knappen*, for at indstille den ønskede grillstyrke, tryk herefter på , for at bekræfte.

VARIGHED

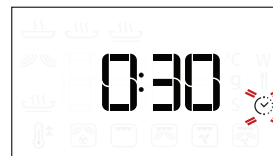

Når ikonet  blinker på displayet, anvendes *knappen* til at indstille den ønskede tilberedningsvarighed, og tryk så på , for at bekræfte.

Det er ikke nødvendigt, at indstille tilberedningens varighed, hvis du vil administrere tilberedningen manuelt: Tryk på , for at bekræfte og starte funktionen.

Bemærk: Under tilberedningen kan man justere tilberedningsvarigheden ved at dreje på *knappen*; hver gang man trykker på , forøges varigheden med 30 sekunder.

LYNOPVARMNING

Vælg funktionen, anvend herefter *knappen* til at indstille den ønskede temperatur og tryk på , for at bekræfte og starte funktionen.





Der høres en summetone, når ovnen når op på den indstillede temperatur.

Bemærk: Det frarådes at stille maden i ovnen før denne funktion er afsluttet.

3. AKTIVÉR FUNKTIONEN

Når du har anvendt de indstillinger, du har brug for, trykker du på  for at aktivere funktionen.

Hver gang der trykkes på knappen  igen, øges tilberedningstiden med yderligere 30 sekunder.

Bemærk: Du kan til enhver tid trykke på , for at stoppe den aktive funktion.

. JET START

Når ovnen er slukket, kan man trykke på , for at aktivere tilberedning med mikrobølgefunktionen, indstillet på højeste niveau (900 W) i 30 sekunder.

. SIKKERHEDSLÅS

Denne funktion aktiveres automatisk for at forhindre, at ovnen slukkes ved et uheld.



Åbn og luk lågen, og tryk så på , for at starte funktionen.

4. PAUSE

Du skal blot åbne lågen for at stoppe en funktion midlertidigt, for eksempel for at røre i eller vende maden.

For at starte den igen, skal du lukke lågen og trykke på .

AUTOMATISK PAUSE (RØR I ELLER VEND MADEN)

Visse funktioner forudser en pause, hvor man kan vende eller røre i maden.



Åbn lågen, når ovnen stiller tilberedningen i bero, og udfør den forespurgte handling, inden du lukker lågen igen og trykker på , for at fortsætte tilberedningen.

5. TILBEREDNINGENS SLUTTID

Der lyder et hørbart signal og displayet vil angive, at tilberedningen er fuldført.



Tilberedningstiden kan forlænges uden at ændre indstillingerne, ved at dreje på *knappen*, for at indstille en ny tilberedningstid, og trykke på .

. AFKØLER

Når en varmluftfunktion er færdig, starter apparatet muligvis en afkølingsprocedure. "Cool On" vises på displayet. Herefter slukker ovnen automatisk.

Bemærk: Afkølingsproceduren kan afbrydes ved at åbne ovndøren og genoptages, om nødvendigt, eventuelt igen ved at lukke ovndøren igen.

. NØGLELÅS

Tryk og hold  trykket i mindst 5 sekunder, for at blokere tastaturet.































































Gentag proceduren for at oplås tastaturet.

Bemærk: Tastblokeringen kan også aktiveres under tilberedningen.









Af sikkerhedsmæssige årsager kan ovnen til enhver tid slås fra ved at trykke og holde knappen  trykket.

TILBEREDNINGSTABEL

MAD	FUNKTION	FORVARMNING	TEMP. (°C)	EFFEKT (W)	VARIGHED	TILBEHØR
Kager med hævemiddel		-	160 - 180	-	30 - 60	
		-	160 - 180	90	25 - 50	
Fyldte tærter (oste- og æbletærter, strudel)		Ja	160-190	-	35 - 70	
Småkager		Ja	170-180	-	10 - 20	
Marengs		Ja	100-120	-	40 - 50	
Rundstykker		Ja	210-220	-	10 - 12	
Brød		Ja	180-200	-	30 - 35	
Pizza/tærte		Ja	190-220	-	20 - 40	
Pizza (0,4-0,5 Kg)		-	-	-	14 - 16	
Småretter (grønsagstærter, quiche Lorraine)		Ja	180-190	-	40 - 55	
Quiche Lorraine (1-1,2 Kg)		-	-	-	18 - 20	
Lasagne/pasta i ovn		-	-	350 - 500	15 - 40	
Lam eller kalvesteg/oksesteg (1,3-1,5 kg)		-	170-180	-	70 - 80*	
		-	160-180	160	50 - 70*	
Oksesteg - medium (1,3-1,5 kg)		-	170-180	-	40 - 60*	
Stegt kylling / kanin / and (hel 1-1,2 kg)		-	210-220	-	50 - 70*	
		-	210-220	350	45 - 60*	
Kylling / kanin / and (0,4-1 fileter / stykker)		-	-	350 - 500	20 - 40*	
		-	-	-	12 - 18	
Ovnstegt fisk (hel)		-	-	160 - 350	20 - 40	
Fiskefiletter/skiver		Ja	-	-	15 - 30*	
Fyldte grøntsager (tomater, courgetter, auberginer...)		-	-	500 - 650	25 - 50	
Toast		-	-	-	3 - 6	
Medisterpølse/grillspyd/spareribs/ hakkebøf		-	-	-	20 - 40*	
Pølser / Burgere (0,2-1 kg)		Ja**	-	-	6 - 16	
Ovnstegte kartofler		-	-	350 - 500	20 - 40*	
Kartoffelbåde (0,3-0,8 kg)		-	-	-	10 - 20	
Bagt frugt		-	-	160 - 350	15 - 25	
Grønsagsgratin		-	-	-	15 - 25	
Stegte grøntsager (0,3-0,8 kg)		Ja**	-	-	8 - 18	

* Vend maden, når halvdelen af tilberedningstiden er gået.

** Forvarm Crisp-panden i 3-5 minutter.

FUNKTIONER	Crisp 	Varmluft 	Varmluft + mikro 	Grill 	Grill + MB 
TILBEHØR	Ildfast plade/beholder, der egner sig til brug i mikrobølgeovne 	Risten 	Rektangulær bageplade 	Crisp-pande 	

RENGØRING

Sørg for, at apparatet er koldt, inden du foretager vedligeholdelse eller rengøring.

Anvend ikke damprensere.

Brug ikke metalsvampe, skuremidler eller slibende/ætsende rengøringsmidler, da disse kan beskadige apparatets overflader.

INDVENDIGE OG UDVENDIGE OVERFLADER

- Rengør overfladerne med en fugtig klud af mikrofibre. Tilføj et par dråber neutralt rengøringsmiddel, hvis de er meget snavsede. Tør efter med en tør klud.
- Anvend et velegnet flydende rengøringsmiddel til rengøring af ruden i ovnens låge.
- Fjern drejetallerkenen og dens støtte jævnlige eller i tilfælde af spild for at fjerne alle madrester.
- Det er ikke nødvendigt at rengøre grillen, da intens varme brænder eventuelt snavs væk. Brug denne funktion jævnlige.

TILBEHØR

Alle tilbehør kan vases i opvaskemaskine med undtagelse af Crisp-panden. Crisp-panden skal rengøres ved brug af vand med et mildt opvaskemiddel. Gnid blidt med en klud for fastbrændt snavs. Lad altid Crisp-panden afkøle, inden den rengøres.

FEJLFINDING

Problem	Mulig årsag	Løsning
Ovnen fungerer ikke.	Ingen strøm. Afbrydelse fra lysnettet.	Kontrollér, om der er strømafbrydelse, og om stikket sidder i stikkontakten. Sluk og tænd igen for ovnen, for at kontrollere, om fejlen er afhjulpet.
Ovnen udsender støj, selv når den er slukket.	Aktiv køleblæser.	Åbn ovnens låge eller hold  trykket.
Displayet viser bogstavet "F", efterfulgt af et bogstav eller tal.	Softwarefejlf.	Kontakt det nærmeste servicecenter og angiv det bogstav eller nummer, der står efter bogstavet "F".

OPLYSNINGSSKEMA

 [www](http://www.docs.whirlpool.eu) Produktets oplysningsskema med energidata kan downloades fra websiden docs.whirlpool.eu

SÅDAN FÅR DU FAT PÅ BRUGS- OG VEDLIGEHOLDELSERVEJLEDNINGEN PÅ

>  www Download Brugs- og vedligeholdelsesvejledningen fra vores website docs.whirlpool.eu (du kan bruge denne QR-kode), ved at angive produktets kommercielle kode.

> Som alternativ kan du ringe til vores kundeserviceafdeling



SÅDAN KONTAKTER DU VORES SERVICEAFDELING

Du kan finde vores kontaktoplysninger i garantihæftet. Når du kontakter vores kundeserviceafdeling, bedes du angive koderne på dit produkts identifikationsskilt.

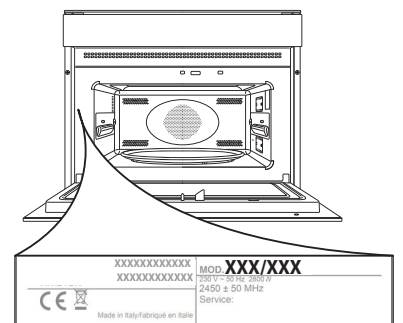

400011091756/B

Printed in Italy

SNELLE REFERENTIE GIDS



WIJ DANKEN U VOOR UW AANKOOP VAN EEN WHIRLPOOL PRODUCT

Voor meer gedetailleerde hulp en assistentie, registreer uw product op www.whirlpool.eu/register



U kunt de Veiligheidsinstructies en de Gids voor Gebruik en Onderhoud downloaden van onze website docs.whirlpool.eu en de instructies aan de achterzijde van dit boekje opvolgen.



**Lees voordat u het apparaat gaat gebruiken zorgvuldig de gids voor
Gezondheid en Veiligheid.**

PRODUCTBESCHRIJVING

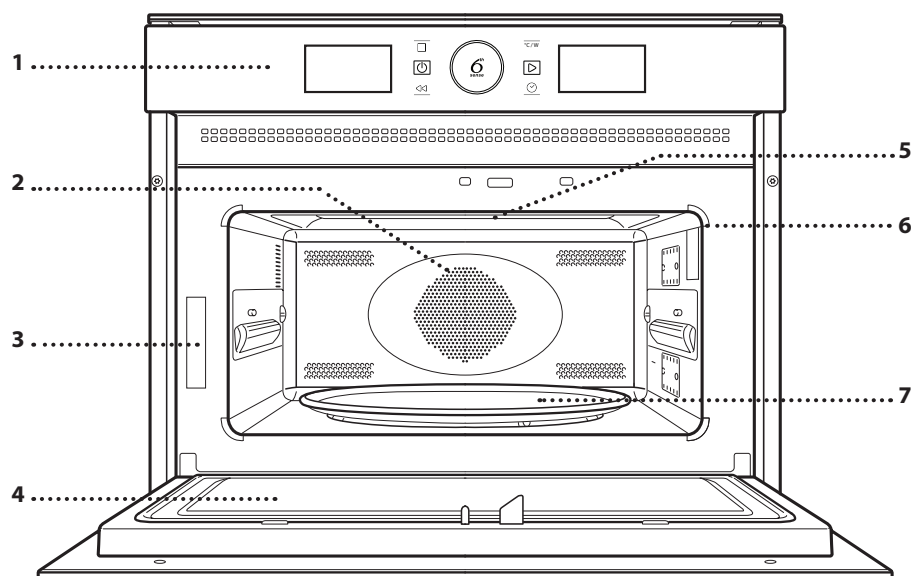

1. Bedieningspaneel
2. Circulair verwarmingselement (niet zichtbaar)
3. Identificatieplaatje (niet verwijderen)
4. Deur
5. Bovenste verwarmingselement/grill
6. Licht
7. Draaiplateau

BEDIENINGSPANEEL

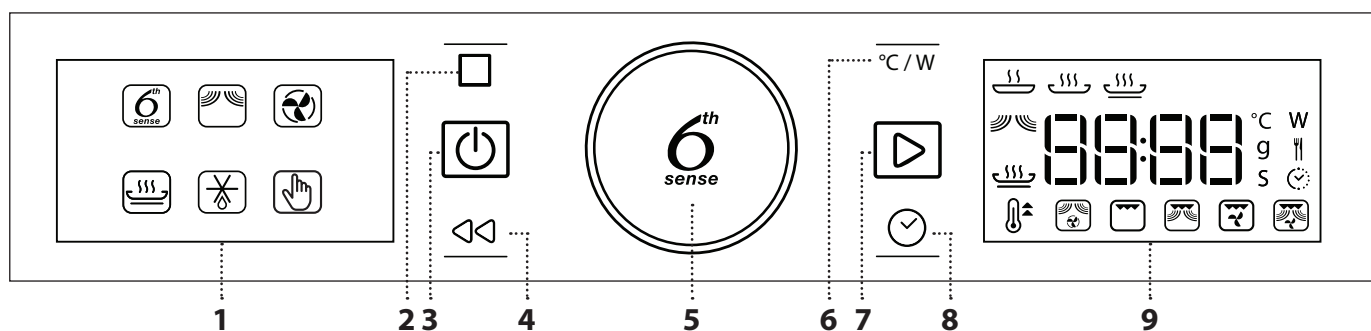

1. LINKER DISPLAY

2. PAUZE

Om een bereidingsprogramma te onderbreken

3. ON/OFF

Om de oven aan en uit te zetten en om een actieve functie op elk gewenst moment te stoppen.

4. TERUG

Om terug te gaan naar het vorige menu.

5. DRAAIKNOP / 6th SENSE-KNOP

Draai de draaiknop rond om de functies te doorlopen en alle bereidingsparameters in te stellen. Druk op de toets  om functies of parameters te selecteren, in te stellen, toegang ertoe te krijgen en te bevestigen en ook om vervolgens het bereidingsprogramma te starten.

6. VERMOGEN

Om de temperatuur, het grillniveau of het magnetronvermogen in te stellen.

7. START

Voor het starten van de functies en de bevestiging van de instellingen

8. TIJD

Voor het instellen van de tijd ofwel het instellen of aanpassen van de bereidingstijd.

9. RECHTER DISPLAY

ACCESSOIRES

DRAAIPLATEAU

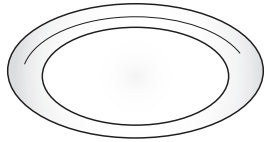

Wanneer het glazen draaiplateau op de plateaudrager wordt gezet kan het voor alle bereidingsmethoden worden gebruikt.

Het draaiplateau moet altijd

als basis voor andere schalen of accessoires worden gebruikt, behalve de rechthoekige bakplaat.

PLATEAU DRAGER

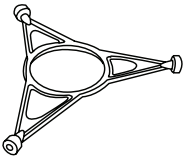

Gebruik de plateaudrager alleen als steun voor het glazen draaiplateau. Laat er geen andere accessoires tegen rusten.

CRISPERPLAAT

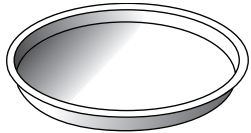

Alleen voor gebruik met de daarvoor bestemde functie. De crisperplaat dient altijd in het midden van het glazen draaiplateau te worden geplaatst en kan worden voorverwarmd

wanneer deze leeg is, de speciale functie wordt uitsluitend voor dit doel gebruikt. Zet het voedsel rechtstreeks op de crisplaat.

HANDGREEP VOOR DE CRISPERPLAAT

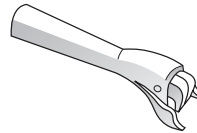

Handig om de hete crisperplaat uit de oven te halen.

ROOSTER

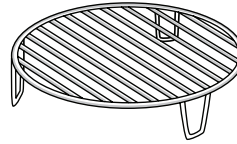

Hiermee kan het voedsel dichterbij de grill worden geplaatst, om het gerecht een perfect bruin korstje te geven. Plaats het rooster op het draaiplateau, zodat het niet in contact met

andere oppervlakken komt.

RECHTHOEKIGE BAKPLAAT

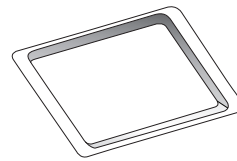

Gebruik de bakplaat uitsluitend met functies die voor convectiebakken zijn toegestaan; Nooit gebruiken met magnetronovens.

Plaats de plaat horizontaal en

laat het rusten op het rooster in de ovenruimte.

Let op: Wanneer de rechthoekige bakplaat wordt gebruikt hoeven het draaiplateau en de steun niet verwijderd te worden.

Het aantal en type.

Bij de Whirlpool Consumentenservice kunt u apart andere, niet bijgeleverde, accessoires aanschaffen.

Er zijn verschillende accessoires verkrijgbaar. Overtuig u er vóór de aankoop van dat deze geschikt zijn voor gebruik in de magnetron en bestand tegen oventemperaturen.

Er mogen nooit metalen schalen voor voedsel of drank voor bereiding in de magnetron worden gebruikt.

Altijd zorgen dat de voedingsmiddelen en accessoires niet in contact met de binnenwanden van de oven komen.

Controleer altijd of het draaiplateau vrij kan draaien voordat u de oven start. Let op dat het draaiplateau niet losraakt bij het plaatsen of verwijderen van andere accessoires.

FUNCTIES



6th SENSE- FUNCTIES

Met de 6th Sense-functies kunt u simpelweg het type en gewicht of de hoeveelheid voedsel selecteren voor het verkrijgen van de beste resultaten. De oven berekent automatisch de optimale instellingen en ze blijven veranderen wanneer de bereiding vordert. De totale bereidingstijd is exclusief de tijd voor het voorverwarmen.

6th SENSE OPWARMEN

Voor het opwarmen van kant-en-klaar voedsel, ingevroren of op kamertemperatuur. De oven berekent automatisch de gewenste instellingen voor de beste resultaten, zo kort mogelijk. Plaats het voedsel op een bord of schaal die magnetronbestendig en ovenvast zijn.

CATEGORIE	VOEDSEL	GEWICHT
	KANT-EN-KLAAR MAALTIJD	250 - 500 g
	DIEPVRIESMAALTIJD	250 - 500 g
	DIEPVRIESLASAGNE	250 - 500 g
	SOEPEN	200 - 800 g
	DRANKEN	1 - 5

6th SENSE BEREIDEN

Om snel voedsel te bereiden en optimale resultaten te bereiken. Gebruik een hittebestendige plaat/schaal die is geschikt voor gebruik in magnetrons.

CATEGORIE	VOEDSEL	GEWICHT
	GEBAKKEN AARDAPPELEN (Omdraaien als dit wordt gevraagd)	200 g - 1 kg
	VERSE GROENTEN (In stukken van gelijke grootte snijden en 2 tot 4 theelepels water toevoegen) Afdekken)	200 - 800 g
	DIEPVRIESGROENTEN (Omdraaien wanneer dit wordt gevraagd. Afdekken)	200 - 800 g
	GROENTEN UIT BLIK	200 - 600 g
	POPCORN	100 g

6th SENSE CRISP

Voor het snel opwarmen en bereiden van ingevroren voedsel, en het een goudbruin, knapperig laagje te geven. Gebruik alleen de bijgeleverde crisperplaat bij deze functie. Draai het voedsel om als dit wordt aangegeven.

CATEGORIE	VOEDSEL	GEWICHT
	FRIETEN (in een enkele laag uitspreiden en vóór de bereiding met zout bestrooien)	200 - 600 g
	PIZZA, DUNNE BODEM	200 - 500 g
	PIZZA, DIKKE BODEM	300 - 800 g
	KIPVLEUGELS, KIPSTUKKEN (Vet de plaat in met een beetje olie)	200 - 600 g
	VISSTICKS (Crisperplaat moet voorverwarmd zijn)	200 - 600 g

Benodigde accessoires: **Crisperplaat, handgreep voor de crisperplaat**



MAGNETRON

Om voedsel en dranken snel te bereiden en op te warmen.

VERMOGEN	AANBEVOLEN VOOR
900 W	Snel opwarmen van dranken of andere voedingsmiddelen met een hoog watergehalte
750 W	Bereiden van groenten
650 W	Bereiden van vlees en vis
500 W	Bereiden van vleessauzen of sauzen met kaas of ei. Afwerken van vleespasteien of pasta uit de oven
350 W	Langzame, voorzichtige bereiding. Perfect voor het laten smelten van boter of chocolade
160 W	Ontdooien van ingevroren voedsel of zacht laten worden van boter en kaas
90 W	Ijs zacht laten worden



HETE LUCHT

Om gerechten te bereiden op een manier die heel dicht aanleunt bij het gebruik van een traditionele oven.

De bakplaat of ander gerei dat geschikt is voor gebruik in de oven kan aangewend worden om bepaalde etenswaren te bereiden.

Aanbevolen accessoires: **Rechthoekige bakplaat, rooster**



CRISP

Om een gerecht een perfect bruin korstje, zowel bovenop als onderaan het voedsel, te geven.. Deze functie mag alleen met de speciale Crisperplaat gebruikt worden.

Benodigde accessoires: Crisperplaat, handgreep voor de crisperplaat



JET DEFROST

Voor het snel ontdooien van verschillende soorten voedsel, door gewoon het gewicht door te geven. Het voedsel moet rechtstreeks op het glazen draaiplateau worden geplaatst. Draai het voedsel om als dit wordt aangegeven.

CATEGORIE	VOEDSEL	GEWICHT
	VLEES (gehakt, moten, steaks, braadstukken)	100 g - 2 kg
	GEVOGELTE (hele kip, stukken, filets)	100 g - 2,5 kg
	VIS (heel, moten, filets)	100 g - 2 kg
	GROENTEN (gemengde groenten, doperwten, broccoli enz.)	100 g - 2 kg
	BROOD (heel brood, broodjes, kadetjes)	100 g - 1 kg



HANDMATIGE FUNCTIES



SNEL VERWARMEN

Om de oven voor een bereidingscyclus voor te verwarmen. Wacht tot het einde van de functie alvorens het voedsel in de oven te plaatsen.



HETELUCHT + MG

Om in korte tijd ovenschotels te bereiden.

Benodigde accessoires: rooster



GRILL

Om het voedsel een bruin korstje te geven, om te grillen of te gratineren. Het is raadzaam om het voedsel tijdens de bereiding te draaien. Voor de beste resultaten de grill 3 à 5 minuten voorverwarmen.

Benodigde accessoires: rooster



GRILL + MAGNETRON

Om gerechten snel te bereiden en te gratineren, een combinatie van de magnetron en grillfuncties.

Benodigde accessoires: rooster



TURBO GRILL

Voor perfecte resultaten, een combinatie van de grill en convectiefuncties. Het is raadzaam om het voedsel tijdens de bereiding te draaien.

Benodigde accessoires: rooster



TURBOGRILL + MG

Om het voedsel snel te bereiden en een bruin korstje te geven, een combinatie van de magnetron, grill en convectieovenfuncties.

Benodigde accessoires: rooster

EERSTE GEBRUIK

. INSTELLING VAN HET HUIDIGE TIJDSTIP

Stel de tijd in wanneer u de oven voor de eerste keer aan zet.



Op het display gaan de twee cijfers die het uur aangeven knippen: Draai aan *de knop* om de uren in te stellen en druk op om te bevestigen.





Op het display gaan de twee cijfers die de minuten aangeven knippen. Draai aan *de knop* om de minuten in te stellen en druk op om te bevestigen.

Let op: Om het uur later te veranderen wanneer de oven uit staat houdt u tenminste één seconde lang ingedrukt en herhaalt u de bovenstaande stappen.

Wanneer de stroom voor langere tijd uitvalt moet u de tijd mogelijk opnieuw instellen.

DAGELIJKS GEBRUIK

1. SELECTEREN VAN EEN FUNCTIE

Als de oven uitgeschakeld is wordt alleen de tijd op het display weergegeven. Houd  ingedrukt om de oven in te schakelen. Draai aan de *knop* om de hoofdfuncties op de linkerdisplay te bekijken. Selecteer een functie en druk op .

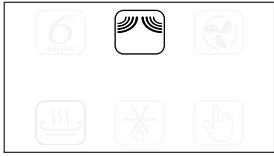

Kies voor het selecteren van een subfunctie (indien aanwezig) de hoofdfunctie en druk daarna op  om te bevestigen en ga naar het functiemenu.



Draai aan de *knop* om een keuze te maken uit de subfuncties op de rechter display en druk op  om te bevestigen.



2. EEN FUNCTIE INSTELLEN

. AUTOMATISCHE FUNCTIES / JET DEFROST

VOEDINGSGROEP

Als u een van de automatische functies heeft gekozen, moet u een categorie selecteren voor het te bereiden voedsel.



Draai aan de *knop* als het symbool  knippert om de gewenste categorie te kiezen. Druk vervolgens op  om te bevestigen.

GEWICHT

Om de beste resultaten te kunnen verkrijgen moet u voor de automatische functies en (en Jet Defrost) het gewicht van het voedsel invoeren, door een keuze uit de standaardinstellingen te maken: de oven zal de ideale tijdsduur voor de functie voor elke voedselcategorie berekenen.



Draai aan de *knop* om het gewicht in te stellen en druk op  om te bevestigen wanneer de standaardinstelling op het display wordt weergegeven en het symbool  knippert.

. HANDMATIGE FUNCTIES

Nadat u de gewenste functie hebt geselecteerd kunt u de instellingen wijzigen. Op het display verschijnen de instellingen die in de juiste volgorde kunnen worden gewijzigd.

MAGNETRONVERMOGEN / TEMPERATUUR



Wanneer het pictogram **W** knippert op de display, aan de *knop* draaien om de instelling te veranderen, daarna op  drukken om te bevestigen en verder gaan met het wijzigen van de instellingen die volgen (indien mogelijk).

Let op: Als de functie geactiveerd is kan het vermogen worden aangepast door het menu instellingen met een druk op  te openen. Draai vervolgens aan de *knop* om de instelling te wijzigen.

GRILLVERMOGEN

Er zijn drie vermogensniveaus voor grillen vastgelegd: 1 (laag), 2 (midden), 3 (hoog). De defaultwaarde wordt weergegeven tussen twee knipperende symbolen "-".



Draai de *knop* om het gewenste grillniveau in te stellen en druk op  om te bevestigen.

DUUR



Wanneer het  symbool knippert op de display, gebruik de *knop* om de gewenste bereidingstijd in te stellen en druk dan op  om te bevestigen.

Wanneer u de bereiding handmatig wilt beheren hoeft u geen bereidingstijd in te stellen: Druk op  om te bevestigen en de functie te starten.

Opmerking: Tijdens de bereiding kunt u de bereidingsduur aanpassen door aan de *knop* te draaien; bij elke druk op  wordt de bereidingsduur met 30 seconden verlengd.

SNEL VERWARMEN

Selecteer de functie. Stel vervolgens met de *knop* de gewenste doeltemperatuur in met de *knop*. Druk ter bevestiging op  om de functie te starten.



Wanneer de oven de doeltemperatuur bereikt, gaat een zoemer af.

Let op: Het wordt aanbevolen om het einde van deze functie af te wachten, alvorens voedsel in de oven te plaatsen.

3. DE FUNCTIE INSCHAKELEN

Wanneer u alle gewenste instellingen toegepast hebt, druk op  om de functie te activeren.

Telkens wanneer de  toets opnieuw wordt ingedrukt wordt de bereidingstijd met nog eens 30 seconden verhoogd.

Let op: U kunt op elk gewenst moment op  drukken om de functie die momenteel actief is te onderbreken.

. JET START

Wanneer de oven is uitgeschakeld, kunt u op  drukken om het bereiden met de magnetronfunctie in te schakelen, op volle kracht (900 W) voor 30 seconden.

. VEILIGHEIDSSLOT

Deze functie wordt automatisch ingeschakeld, om te voorkomen dat de oven per ongeluk wordt ingeschakeld.



Open en sluit de deur, druk vervolgens op  om de functie te starten.

4. PAUZE

Als u een actieve functie wilt onderbreken, bijvoorbeeld om het voedsel te roeren of te draaien, kunt u gewoon de deur openen.

Om opnieuw op te starten sluit u de deur en drukt u nogmaals op .

AUTOMATISCHE PAUZE

(HET VOEDSEL DOORROEREN OF OMDRAAIEN)

Bepaalde functies hebben pauzes, zodat de gebruiker het voedsel kan draaien of roeren.



Zodra de oven de bereiding heeft onderbroken opent u de deur en voert u de gevraagde actie uit voordat de deur weer wordt gesloten en u drukt op  om door te gaan met de bereiding.

5. EINDE BEREIDINGSDUUR

Er klinkt een geluidssignaal en op het display wordt aangegeven dat de bereiding klaar is.



Voor het verlengen van de bereidingstijd zonder de instellingen te veranderen draait u aan de *knop* om een nieuwe bereidingstijd in te stellen en drukt u op .

. AFKOELEN

Als een warmeluchtfunctie klaar is, kan het apparaat een afkoelingsprocedure uitvoeren.

Het display toont "Cool On".

Na deze procedure wordt de oven automatisch uitgeschakeld.

Let op: de afkoelingsprocedure kan onderbroken worden door de deur te openen en wordt zo nodig opnieuw geactiveerd door de deur terug te sluiten.

. VERGRENDING

Om de toetsen te vergrendelen houdt u  tenminste 5 seconden lang ingedrukt.































































Doe dit opnieuw om de toetsen vrij te geven.

Let op: Het toetsenbord kan ook tijdens de bereiding worden vergrendeld.









Om veiligheidsredenen kan de oven om het even wanneer uitgeschakeld worden door de toets  ingedrukt te houden.

BEREIDINGSTABEL

VOEDSEL	FUNCTIE	VOORVER- WARMEN	TEMP. (°C)	VERMOGEN (W)	DUUR	ACCESSOIRES
Luchtig gebak		-	160 - 180	-	30 - 60	
		-	160 - 180	90	25 - 50	
Gevulde taarten (cheesecake, strudel, appeltaart)		Ja	160-190	-	35 - 70	
Koekjes		Ja	170-180	-	10 - 20	
Meringues		Ja	100-120	-	40 - 50	
Broodjes		Ja	210-220	-	10 - 12	
Heel brood		Ja	180-200	-	30 - 35	
Pizza/Pastei		Ja	190-220	-	20 - 40	
Pizza (0,4-0,5 kg)		-	-	-	14 - 16	
Hartige taarten (groentetaart, quiche Lorraine)		Ja	180-190	-	40 - 55	
Quiche Lorraine (1-1,2 kg)		-	-	-	18 - 20	
Lasagne / Gebakken pasta		-	-	350 - 500	15 - 40	
Gebraden lams-/kalfsvlees/rosbief (1,3-1,5 kg)		-	170-180	-	70 - 80*	
		-	160-180	160	50 - 70*	
Rosbief - medium (1,3 -1,5 kg)		-	170-180	-	40 - 60*	
Gebraden kip/konijn/eend (heel 1-1,2 kg)		-	210-220	-	50 - 70*	
		-	210-220	350	45 - 60*	
Kip / Konijn / Eend (filets / stukken 0,4-1 kg)		-	-	350 - 500	20 - 40*	
		-	-	-	12 - 18	
Gebakken vis (heel)		-	-	160 - 350	20 - 40	
Visfilets/moten		Ja	-	-	15 - 30*	
Gevulde groenten (tomaten, courgettes, aubergines...)		-	-	500 - 650	25 - 50	
Toast		-	-	-	3 - 6	
Worstjes/spiesen/ spareribs/ hamburgers		-	-	-	20 - 40*	
Worstjes/Hamburgers (0,2-1 kg)		Ja **	-	-	6 - 16	
Gebakken aardappels		-	-	350 - 500	20 - 40*	
Aardappelpartjes (0,3-0,8 kg)		-	-	-	10 - 20	
Gebakken fruit		-	-	160 - 350	15 - 25	
Gegratin. groenten		-	-	-	15 - 25	
Gefrituurde groenten (0,3-0,8 kg)		Ja **	-	-	8 - 18	

* Draai het vlees halverwege de bereidingstijd om.

** De Crisp-plaat 3 à 5 minuten voorverwarmen.

FUNCTIES	Crisp 	Hetelucht 	Hetelucht + MG 	Grill 	Grill + Magnetron 
ACCESSOIRES	Hittebestendige plaat/schaal, geschikt voor gebruik in magnetrons 		Rooster 	Rechthoekige bakplaat 	Crisp-plaat 

REINIGEN

Zorg ervoor dat het apparaat afgekoeld is vooraleer te onderhouden of te reinigen.

Gebruik geen stoomreinigers.

Gebruik geen staalwol, schuursponsjes of schurende/bijtende reinigingsproducten, omdat deze het oppervlak van het apparaat kunnen beschadigen.

OPPERVLAKKEN BINNENKANT EN BUITENKANT

- Reinig de oppervlakken met een vochtig microvezeldoekje. Als ze zeer vuil zijn, voeg dan een paar druppels neutraal afwasmiddel toe aan het water. Droog af met een droge doek.
- Maak het glas van de deur schoon met een geschikt vloeibaar reinigingsmiddel.
- Verwijder het draaiplateau en de steun op gezette tijden, of wanneer er vloeistoffen gemorst zijn, om de onderkant van de oven schoon te maken en verwijder alle voedselresten.
- De grill hoeft niet te worden gereinigd, want de intense hitte brandt al het vuil weg. Gebruik deze functie regelmatig.

ACCESSOIRES

Alle accessoires zijn vaatwasmachinebestendig, met uitzondering van de crisperplaat. De crisperplaat moet worden afgewassen met water en een mild afwasmiddel. Bij hardnekkig vuil zachtjes met een doek wrijven. Laat de crisplaat altijd afkoelen voordat u deze schoonmaakt.

PROBLEEMOPLOSSING

Probleem	Mogelijke oorzaak	Oplossing
De oven werkt niet.	Stroomonderbreking. Koppel het los van het elektriciteitsnet.	Controleer of het elektriciteitsnet spanning heeft en of de oven is aangesloten. Zet de oven uit en weer aan, om te controleren of het probleem opgelost is.
De oven maakt geluid zelfs wanneer deze is uitgeschakeld.	Koelventilator ingeschakeld.	Open de deur of druk op  .
Op de display verschijnt de letter "F" gevolgd door een letter of nummer.	Softwarefout.	Neem contact op met de dichtstbijzijnde Consumentenservice en vermeld de letter of het nummer dat volgt op de letter "F".

PRODUCT

 [www](http://www.docs.whirlpool.eu) De productfiche met energiegegevens van dit apparaat kan gedownload worden van onze website docs.whirlpool.eu

HOE DE GIDS VOOR GEBRUIK EN ONDERHOUD TE VERKRIJGEN

>  [www](http://www.docs.whirlpool.eu) Download de Gids voor Gebruik en Onderhoud op onze website docs.whirlpool.eu (u kunt deze QR code gebruiken), onder vermelding van de handelscode van het product.

> U kunt ook contact opnemen met onze Consumentenservice



CONTACT OPNEMEN MET CONSUMENTENSERVICE

Onze contactgegevens staan in de garantiehandleiding. Wanneer u contact opneemt met de Consumentenservice gelieve de codes te vermelden die op het identificatieplaatje van het apparaat staan.

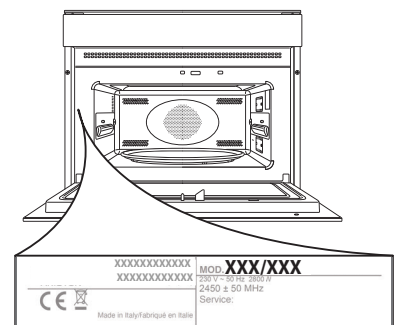

400011091756/B

Printed in Italy

PÄIVITTÄISKÄYTÖN VIITE

- OPAS



KIITOS SIITÄ, ETTÄ OSTIT WHIRLPOOL-TUOTTEEN

Täydemmän avun ja tuen saamiseksi rekisteröi tuotteesi sivustolla www.whirlpool.eu/register



Voit ladata Turvaohjeet sekä Käyttö- ja huolto-oppaan verkkosivuiltamme docs.whirlpool.eu ja noudattamalla tämän vihkosen takakannen ohjeita.

! Lue terveyttä ja turvallisuutta koskevat ohjeet huolellisesti ennen laitteen käyttöä.

TUOTTEEN KUVAUS

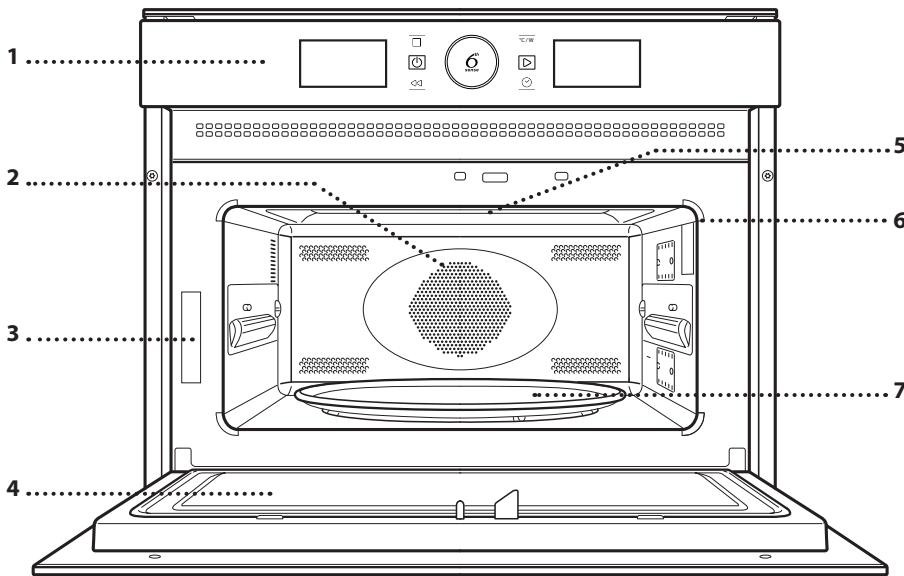

1. Käyttöpaneeli
2. Pyöreä lämmitysvastus (ei näkyvässä)
3. Tunnistekilpi (älä poista)
4. Luukku
5. Ylempi lämpövastus/grilli
6. Valo
7. Lasialusta

OHJAUSPANEELI

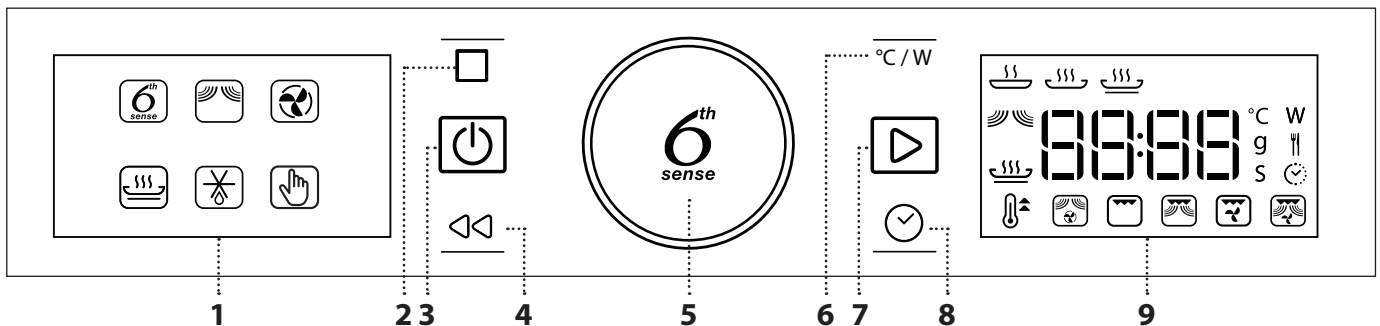

1. VASEN NÄYTTÖ

2. TAUKO

Keskeyttää kypsennysjakson tauon ajaksi

3. VIRTAPAINIKE

Kytkee uunin päälle ja pois päältä sekä keskeyttää aktiivisen toiminnon milloin tahansa.

4. TAKAISIN

Palaa edelliseen näkymään.

5. PYÖRÖNUPPI / 6th SENSE -PAINIKE

Valitsinta kääntämällä selaillaan toimintoja sekä säädetään kaikki kypsennysparametrit. Painamalla  valitaan, asetetaan, avataan ja vahvistetaan toimintoja tai parametreja sekä käynnistetään kypsennysohjelma.

6. TEHO

Säätää lämpötilan, grillaustehon tai mikroaaltotehon.

7. KÄYNNISTÄ

Käytetään toimintojen käynnistämiseen sekä asetusten vahvistamiseen

8. AIKA

Käytetään kellonajan asettamiseen sekä kypsennysajan asettamiseen tai säätämiseen.

9. OIKEA NÄYTTÖ

VARUSTEET

PYÖRIVÄ LAUTANEN

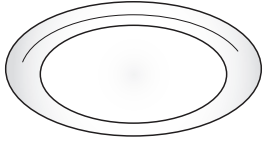

Tukeensa asetettua pyörivää lautasta voidaan käyttää kaikkien kypsennysmenetelmien kanssa. Pyörivää lautasta on käytettävä aina muiden astioiden tai välineiden alustana lukuun

ottamatta suorakulmaista leivinpeltiä.

PYÖRIVÄN LAUTASEN TUKI

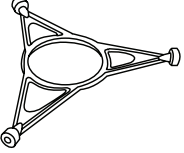

Käytä tukeaa ainoastaan lasilautaselle. Älä aseta tuen päälle muita varusteita.

CRISP-ALUSTA

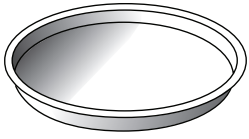

Saa käyttää ainoastaan sille tarkoitetun toiminnon kanssa. Crisp-alusta on laitettava aina pyörivän lautaseen keskelle ja se voidaan esilämmittää tyhjänä käyttämällä tähän tarkoitukseen

tarkoitettua erikoistoimintoa. Aseta ruoka suoraan Crisp-alustalle.

CRISP-ALUSTAN KAHVA

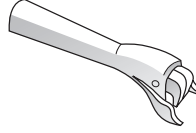

Sen avulla Crisp-alusta voidaan poistaa uunista kätevästi.

RITILÄ

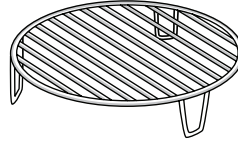

Tämän ansiosta voit asettaa ruoan lähemmäksi grilliä, jolloin se ruskistuu paremmin. Aseta ritilä pyörivälle lautaselle ja varmista, ettei se joudu kosketuksiin muiden pintojen

kanssa.

SUORAKULMAINEN LEIVINPELTI

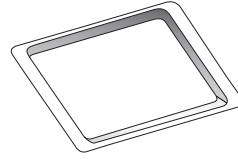

Käytä leivinpeltiä ainoastaan niiden toimintojen kanssa, jotka sallivat perinteisen kypsennyksen; sitä ei saa koskaan käyttää yhdessä mikroaaltolaitteiden kanssa.

Aseta pelti vaakasuoraan tukien se kypsennysosaston telineeseen.

Huomaa: Sinun ei tarvitse poistaa pyörivää lautasta ja sen tukea, kun käytät suorakulmaista leivinpeltiä.

Varusteiden määrä ja tyyppi vaihtelevat ostetun mallin mukaan. Muita lisävarusteita voidaan hankkia erikseen huoltopalvelusta.

Uuneja varten on saatavilla monenlaisia varusteita. Ennen ostoa varmista, että ne sopivat mikroaaltouunissa käytettäväksi ja kestävät uunin lämpötiloja.

Älä koskaan käytä metallisia astioita ruualle tai juomalle mikroaaltouunissa kypsennyksen aikana.

Varmista aina, ettei ruoka ja varusteet joudu kosketuksiin uunin sisäseinien kanssa.

Tarkista aina ennen uunin käyttöä, että alusta voi pyöriä vapaasti. Ole tarkkana, ettet poista pyörivää lautasta paikaltaan muita varusteita laitettaessa tai poistettaessa.

TOIMINNOT



6th SENSE -TOIMINNOT

6th Sense -toimintojen kanssa valitaan yksinkertaisesti elintarvikkeiden tyyppi ja paino tai määrä parhaiden tulosten saamiseksi. Uuni laskee automaattisesti parhaat asetukset ja vaihtaa niitä edelleen kypsymisen edistyessä. Kokonaisuus ei sisällä esikuumennusvaiheita.

6th SENSE KUUMENNUS

Lämmittää uudelleen valmisruokia, jotka ovat joko pakastettuja tai huoneen lämpötilassa. Uuni laskee automaattisesti tarvittavat asetukset, joilla saavutetaan parhaat tulokset lyhimmissä ajassa. Aseta ruoka mikroaaltoja ja kuumuutta kestäväälle lautaselle tai astiaan.

LUOKKA	RUOKA	PAINO
1	ATERIALAUTANEN	250 - 500 g
2*	PAKASTEANNOS	250 - 500 g
3*	PAKASTELASAGNE	250 - 500 g
4	KEITOT	200 - 800 g
5	JUOMAT	1 - 5 dl

6th SENSE KYSENNYS

Kypsentää ruoat nopeasti siten, että saavutetaan parhaat mahdolliset tulokset. Käytä kuumuutta kestävästä astiasta, joka soveltuu käytettäväksi mikroaaltojen kanssa.

LUOKKA	RUOKA	PAINO
1	UUNIPERUNAT (Käännä kehotettaessa)	200 g - 1 kg
2	TUOREET VIHANNEKSET (Leikkaa samankokoisiksi paloiksi ja lisää 2 - 4 ruokalusikallista vettä. Peitä)	200 - 800 g
3*	PAKASTEVIHANNEKSET (Käännä kehotettaessa. Peitä)	200 - 800 g
4	TÖLKKIVIHANNEKSET	200 - 600 g
5	POPCORN	100 g

6th SENSE CRISP

Lämmittää nopeasti ja kypsentää pakasteruoat ja antaa niille kullankeltaisen, rapean pinnan. Käytä tätä toimintoa ainoastaan toimitetun Crisp-alustan kanssa. Käännä ruokaa kehotettaessa.

LUOKKA	RUOKA	PAINO
1*	RANSKALAISET PERUNAT (levitä yhtenä ainoana kerroksena ja ripottele suolaa päälle ennen kypsennystä)	200 - 600 g
2*	PIZZA, OHUTPOHJAINEN	200 - 500 g
3*	PIZZA, PAKSUPOHJAINEN	300 - 800 g
4*	BROILERIN SIIVET, BROILERIN PALAT (Öljyä alustaa hieman)	200 - 600 g
5*	KALAPUIKOT (Crisp-alusta tulee esilämmittää)	200 - 600 g

Tarvittavat varusteet: **Crisp-alusta ja Crisp-alustan kahva**



MIKROAALTO

Lämmittää ja kypsentää ruoat tai juomat nopeasti.

TEHO	SUOSITUKSET
900 W	Juomien tai erittäin vesipitoisten ruokien nopea lämmittäminen uudelleen
750 W	Vihannesten kypsennys
650 W	Lihan ja kalan kypsennys
500 W	Lihaa, juustoa tai munaa sisältävien kastikkeiden kypsennys. Lihapiirakoiden tai uunipastan viimeistely
350 W	Hidas, varovainen kypsennys. Sopii hyvin voin tai suklaan sulatukseen
160 W	Pakasteiden sulatus tai voin ja juuston pehmenys
90 W	Jäätelön pehmenys



KIERTOILMA

Kypsentää ruokalajit tavalla, jolla saavutetaan samanlaisia tuloksia kuin perinteisellä uunilla. Tiettyjen ruokien kypsennykseen voidaan käyttää leivinpeltiä tai muuta astiaa, joka voidaan laittaa uuniin.

Suosittelvat varusteet: **Suorakulmainen leivinpelti, ritilä**



CRISP

Ruskista ruuat täydellisesti ylä- ja alapuolelta. Tätä toimintoa saa käyttää ainoastaan erityisen Crisp-alustan kanssa.

Tarvittavat varusteet: Crisp-alusta ja Crisp-alustan kahva



JET DEFROST

Monien erityyppisten ruokien pikaiseen sulattamiseen yksinkertaisesti ilmoittamalla niiden paino. Ruoka on laitettava suoraan pyörivälle lasialustalle. Käännä ruokaa kehotettaessa.

LUOKKA	RUOKA	PAINO
1*	LIHA (jauheliha, kotletit, pihvit, paistit)	100 g - 2 kg
2*	LINNUNLIHA (kokonainen broileri, palat, fileet)	100 g - 2,5 kg
3*	KALA (kokonainen, viipaleet, fileet)	100 g - 2 kg
4*	VIHANNEKSET (sekavihannekset, herneet, parsakaali, jne.)	100 g - 2 kg
5*	LEIPÄ (limput, sämpylät, pullat)	100 g - 1 kg



MANUAALISET TOIMINNOT



PIKAKUUMENNUS

Lämmitä uuni nopeasti uudelleen ennen kypsennysjaksoa. Odota, että toiminto päättyy ennen kuin laitat ruuan uuniin.



KIERTOILMA + MIKROAALLOT

Valmista ruuat nopeasti.

Tarvittavat varusteet: rutilä



GRILLI

Ruskistaa, grillaa ja gratinoi. Suosittelemme kääntämään ruokaa kypsennyksen aikana. Saat parhaat tulokset esilämmittämällä grilliä noin 3-5 minuuttia.

Tarvittavat varusteet: rutilä



GRILLI + MIKROAALLOT

Kypsennä ja gratinoi ruuat nopeasti yhdistämällä mikroaalto- ja grillitoiminnot.

Tarvittavat varusteet: rutilä



TURBOGRILLI

Täydelliset tulokset yhdistämällä grilli ja perinteisen uunin toiminnot. Suosittelemme kääntämään ruokaa kypsennyksen aikana.

Tarvittavat varusteet: rutilä



TURBOGRILLI + MA

Kypsennä ja ruskista ruoka nopeasti yhdistämällä mikroaalto-, grilli- ja perinteisen uunin toiminnot.

Tarvittavat varusteet: rutilä

ENSIMMÄINEN KÄYTTÖKERTA

. KELLONAJAN ASETTAMINEN

Kun kytket uunin päälle ensimmäisen kerran, on tehtävä kelloasetukset.



Kaksi tuntia tarkoittavaa merkkiä alkaa vilkkua: Aseta tunnit kääntämällä *nuppia* ja vahvista sitten painamalla





Kaksi minuutteja tarkoittavaa merkkiä alkaa vilkkua. Aseta minuutit *nuppia* kääntämällä ja vahvista painamalla

Huomaa: Jos haluat vaihtaa kellonajan myöhemmin, paina ja pidä sitä painettuna vähintään sekunnin ajan uunin ollessa sammutettuna ja toista yllä olevat vaiheet.

Sinun on ehkä asetettava aika uudelleen pitkän sähkökatkon jälkeen.

PÄIVITTÄINEN KÄYTTÖ

1. VALITSE TOIMINTO

Kun uuni on sammutettuna, ainoastaan aika näkyy näytöllä. Kytke uuni päälle painamalla  ja pitämällä sitä painettuna. Tärkeimmät käytettävissä olevat toiminnot saadaan näkyviin vasemmalle näytölle kääntämällä *nuppia*. Valitse niistä yksi ja paina .



Jos haluat valita alitoiminnon (silloin kun niitä on), valitse ensin päätoiminto, vahvista sitten painamalla  ja mene toimintovalikkoon.



Valitse oikealla olevasta näytöstä jokin alitoiminnoista *nuppia* kääntäen ja vahvista sitten painamalla .



2. ASETA TOIMINTO

. AUTOMAATTISET TOIMINNOT / JET DEFROST

RUOKALAJIRYHMÄ

Kun olet valinnut yhden automaattisista toiminnoista, on valittava ryhmä, johon kypsennettävä ruokalaji kuuluu.





Kun  -kuvake vilkkuu, valitse haluamasi ryhmä *nuppia* kääntämällä ja vahvista sitten painamalla .

PAINO

Parhaiden tulosten saamiseksi on automaattisia toimintoja (ja Jet Defrost -toimintoa) varten annettava ruoan paino valitsemalla se oletusasetuksista: uuni laskee kyseistä toimintoa ja ruokaryhmää varten ihanteellisen ajan.





Kun oletusasetus tulee näkyviin näytölle ja  -kuvake vilkkuu, aseta paino *nuppia* kääntäen ja vahvista sitten painamalla .

. MANUAALISET TOIMINNOT

Haluamasi toiminnon valitsemisen jälkeen voit muuttaa sen asetuksia. Näytöllä näkyvät järjestyksessä asetukset, joita voit muuttaa.

MIKROAALTOTEHO / LÄMPÖTILA



Kun  -kuvake vilkkuu näytöllä, säädä tehoasetus kääntämällä *nuppia* ja vahvista sitten painamalla  ja jatka sitten muokkaamalla seuraavia asetuksia (jos mahdollista).

Huomaa: Kun toiminto on aktivoitu, tehoa voidaan muuttaa painamalla , joka avaa asetusvalikon, ja kääntämällä sitten *nuppia*, mikä muuttaa asetuksen.

GRILLAUSTEHO

Grillaukselle on kolme ennalta määritettyä tehotasoa: 1 (alhainen), 2 (keski), 3 (korkea). Oletusarvo näkyy kahden vilkkuvan "--" symbolin välissä.



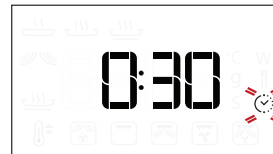

Aseta haluttu grillausteho kääntämällä *nuppia*, vahvista sitten painamalla .

KESTO



Kun kuvake  vilkkuu näytöllä, aseta haluamasi kypsennysaika *nupista* ja vahvista sitten painamalla .

Kypsennysaikaa ei ole pakollista asettaa, jos haluat seurata kypsennystä manuaalisesti: Vahvista painamalla  ja käynnistä toiminto.

Huomaa: Voit säätää kypsennysaikaa kypsennyksen aikana *nuppia* kääntämällä; aina kun painat , kypsennysaika pitenee 30 sekunnilla.

PIKAKUUMENNUS

Valitse toiminto, aseta sitten haluamasi lämpötila *nupista*, vahvista ja käynnistä toiminto painamalla .



Kun uuni on kuumentunut haluttuun lämpötilaan, kuuluu äänimerkki.

Huomaa: Ruokaa ei ole suositeltavaa laittaa uuniin ennen toiminnon päättymistä.

3. AKTIVOI TOIMINTO

Kun olet tehnyt haluamasi asetukset, aktivoi toiminto painamalla .

Joka kerta kun painiketta  painetaan uudelleen, kypsennysaikaa lisätään 30 sekunnilla edelleen.

Huomaa: Voit pysäyttää aktiivisena olevan toiminnon milloin tahansa painamalla .

. JET START

Kun uuni on sammutettuna, voit painaa , joka aktivoi kypsennyksen mikroaaltouunitoiminnolla täydellä teholla (900 W) 30 sekunniksi.

. TURVALUKITUS

Tämä toiminto aktivoidaan automaattisesti, jotta estetään uunin vahingossa tapahtuva päälle kytkeminen.

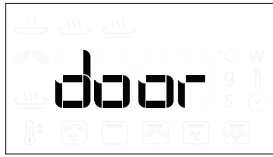

Avaa ja sulje luukku ja käynnistä toiminto sitten painamalla .

4. TAUKO

Aseta aktiivinen toiminto taukotilaan, jotta voit sekoittaa tai kääntää ruuan, yksinkertaisesti avaamalla luukun.

Käynnistä se uudelleen sulkemalla luukku ja painamalla .

AUTOMAATTINEN TAUKO
(SEKOITA TAI KÄÄNNÄ RUOKAA)

Eräisiin toimintoihin kuuluu tauko ruoan kääntämistä tai sekoittamista varten.



Kun uuni on keskeyttänyt kypsennyksen, avaa luukku ja suorita toimenpide, jonka uuni kehottaa suorittamaan, ennen kuin suljet luukun uudelleen ja jatkat kypsennyksen painamalla .

5. KYPSENNYKSEN PÄÄTTYMISAIKA

Kuuluu äänimerkki ja näyttö ilmoittaa, että kypsennys on päätynyt.



Voit pidentää kypsennysaikaa asetuksia muuttamatta valitsemalla uuden kypsennysajan *nuppia* kääntäen ja painamalla sitten .

. JÄÄHDYTYS

Kun kuumaa ilmaa käyttävä toiminto päättyy, laite saattaa suorittaa jäähdytysvaiheen.

Näytössä lukee "Cool On".

Vaiheen loputtua uuni kytkeytyy pois toiminnasta automaattisesti.

Huomaa: jäähdytysvaihe voidaan keskeyttää avaamalla luukku, ja tarpeen vaatiessa se voidaan käynnistää uudelleen sulkemalla luukku uudestaan.

. PAINIKELUKITUS

Painikkeet lukitaan painamalla  ja pitämällä sitä painettuna vähintään 5 sekunnin ajan.



Näppäimistöluukko avataan suorittamalla toimenpide uudelleen.

Huomaa: Painikelukitus voidaan käynnistää myös kypsennyksen ollessa käynnissä.

Turvallisuussyistä uuni voidaan kytkeä pois käytöstä milloin tahansa painamalla painiketta  ja pitämällä sitä painettuna.

KYPSENNYSTAULUKKO

RUOKA	TOIMINTO	ESI-LÄMMITYS	LÄMPÖ (°C)	TEHO (W)	KESTO	VARUSTEET
Kohoavat kakut		-	160 - 180	-	30 - 60	
		-	160 - 180	90	25 - 50	
Täytetyt piiraat (juustokakku, struudeli, omenatorrttu)		Kyllä	160-190	-	35 - 70	
Pikkuleivät		Kyllä	170-180	-	10 - 20	
Marengit		Kyllä	100-120	-	40 - 50	
Sämpylät		Kyllä	210-220	-	10 - 12	
Leipä, limppu		Kyllä	180-200	-	30 - 35	
Pizza / piiraat		Kyllä	190-220	-	20 - 40	
Pizza (0,4-0,5 kg)		-	-	-	14 - 16	
Suolaiset piirakat (kasvispiirakka, Quiche Lorraine)		Kyllä	180-190	-	40 - 55	
Quiche lorraine (1-1,2 kg)		-	-	-	18 - 20	
Lasagne / uunipasta		-	-	350 - 500	15 - 40	
Lampaan- / vasikanpaisti / paahtopaisti (1,3-1,5 kg)		-	170-180	-	70 - 80*	
		-	160-180	160	50 - 70*	
Paahtopaisti – keski (1,3-1,5 kg)		-	170-180	-	40 - 60*	
Paistettu broileri / jänis / ankka (kokonainen 1-1,2 kg)		-	210-220	-	50 - 70*	
		-	210-220	350	45 - 60*	
Broileri / Jänis / Ankka (fileet / palat 0,4-1 kg)		-	-	350 - 500	20 - 40*	
		-	-	-	12 - 18	
Paistettu kala (kokonainen)		-	-	160 - 350	20 - 40	
Kalafileet/palat		Kyllä	-	-	15 - 30*	
Täytetyt vihannekset (tomaatit, kesäkurpitsat, munakoisot, jne.)		-	-	500 - 650	25 - 50	
Paahtoleipä		-	-	-	3 - 6	
Makkarat/lihavartaat/grillikylki/ jauhelihapihvit		-	-	-	20 - 40*	
Makkarat / hampurilaiset (0,2-1 kg)		Kyllä**	-	-	6 - 16	
Uuniperunat		-	-	350 - 500	20 - 40*	
Lohkoperunat (0,3-0,8 kg)		-	-	-	10 - 20	
Paistetut hedelmät		-	-	160 - 350	15 - 25	
Vihannesgratiini		-	-	-	15 - 25	
Paistetut vihannekset (0,3-0,8 kg)		Kyllä**	-	-	8 - 18	

* Käännä ruoka kypsennyksen puolivälissä.

** Esilämmitä Crisp-alustaa 3–5 minuuttia.

TOIMINNOT	Crisp-toiminto 	Kierroilma 	Kierroilma + MA 	Grilli 	Grilli + MA
VARUSTEET	Kuuhuutta kestävä alusta/astia, joka soveltuu käytettäväksi mikroaaltouuneissa 	Ritilä 	Suorakulmainen leivinpelti 	Crisp-alusta 	

PUHDISTUS

Varmista, että laite on jäähtynyt, ennen kuin aloitat huolto- tai puhdistustoimenpiteet.

Älä käytä höyrypesuria.

Älä käytä teräsvillaa, hankaavia kaapimia tai hankaavia/syövyttäviä puhdistusaineita, koska ne voivat vahingoittaa laitteen pintaa.

SISÄ- JA ULKOPINNAT

- Puhdista pinnat kostealla mikrokuituliinalla. Jos pinnat ovat erittäin likaisia, voit käyttää vettä, johon on lisätty muutama pisara neutraalia puhdistusainetta. Kuivaa pinnat lopuksi kuivalla liinalla.
- Puhdista luukun lasi nestemäisellä erikoispesuaineella.
- Säännöllisin väliajoin tai jos ruokaa roiskuu, poista pyörivä lautanen ja sen tuki, jotta voit puhdistaa uunin pohjalta kaikki ruuan jäämät.
- Grilliä ei tarvitse puhdistaa, koska voimakas kuumuus polttaa kaiken lian. Käytä tätä toimintoa säännöllisin väliajoin.

VARUSTEET

Kaikki muut varusteet voidaan pestä astianpesukoneessa paitsi Crisp-alusta. Crisp-alusta on puhdistettava vedellä ja miedolla pesuaineella. Hanka pinttynyt lika pois pehmeällä liinalla. Anna Crisp-alustan jäähtyä ennen puhdistusta.

VIANETSINTÄ

Ongelma	Mahdollinen syy	Korjaus
Uuni ei toimi.	Sähkökatkos. Kytkeytynyt irti verkkovirrasta.	Tarkista, että verkossa on jännite ja että uuni on kytketty verkkoon. Kytke uuni pois päältä ja uudelleen päälle ja tarkista, onko vika poistunut.
Uuni on meluisa myös pois päältä kytkettynä.	Jäähdytyspuhallin on päällä.	Avaa luukku tai pidä painettuna  .
Näytölle tulee "F"-kirjain ja jokin kirjain tai numero.	Ohjelmistovika.	Ota yhteyttä lähimpään huoltopalveluliikkeeseen ja ilmoita "F"-kirjaimen jäljessä oleva kirjain tai numero.

TUOTESELOSTE

 [www](http://www.docs.whirlpool.eu) Laitteen tuoteseloste energiankulutusta koskevine tietoineen on ladattavissa sivustolta docs.whirlpool.eu

MITEN SAADA KÄYTTÖ- JA HUOLTO-OPAS

>  [www](http://www.docs.whirlpool.eu) Lataa käyttö- ja huolto-opas verkkosivuiltamme docs.whirlpool.eu (voit käyttää tätä QR-koodia), ilmoittamalla tuotteen kaupallisen koodin.

> Vaihtoehtoisesti voit ottaa yhteyttä huoltopalveluun



YHTEYDEN OTTAMINEN HUOLTOPALVELUUN

Löydät yhteystietomme takuupöytäkirjasta. Kun otat yhteyttä huoltopalveluun, ilmoita tuotteen tunnistekilvessä olevat koodit.

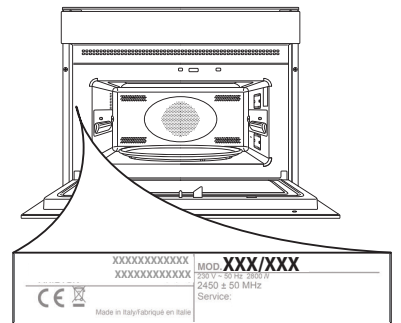

400011091756/B

Printed in Italy

GUIDE D'UTILISATION QUOTIDIENNE



MERCI D'AVOIR ACHETÉ UN PRODUIT WHIRLPOOL

Afin de recevoir un service et un support complet, merci d'enregistrer votre appareil sur www.whirlpool.eu/register



Vous pouvez télécharger les Consignes de sécurité et le Guide d'utilisation et d'entretien en visitant notre site Web docs.whirlpool.eu et en suivant les consignes au dos de ce livret.

! Lire attentivement les Consignes de santé et de sécurité avant d'utiliser l'appareil.

DESCRIPTION DU PRODUIT

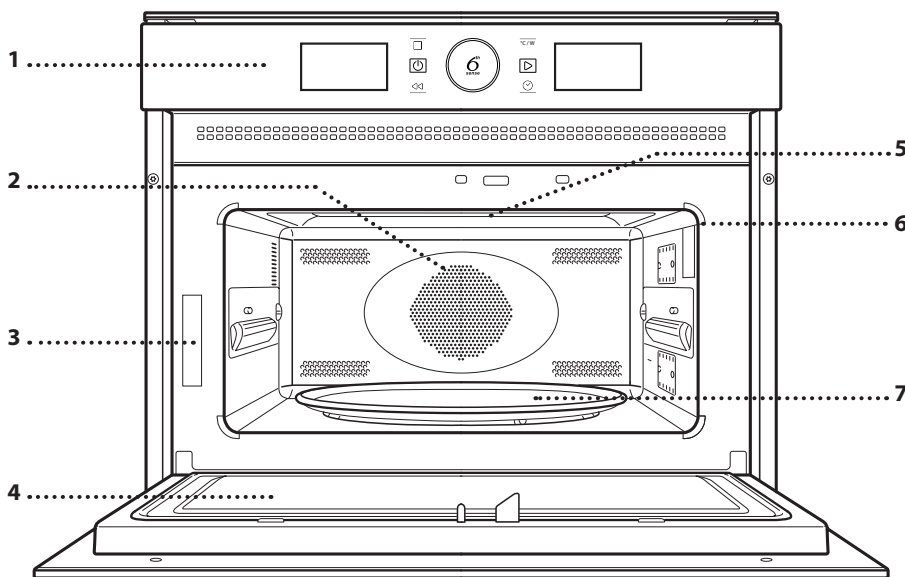

1. Panneau de commande
2. Élément chauffant rond (invisible)
3. Plaque signalétique (ne pas enlever)
4. Porte
5. Élément chauffant supérieur/gril
6. Ampoule
7. Plaque tournante

PANNEAU DE COMMANDE

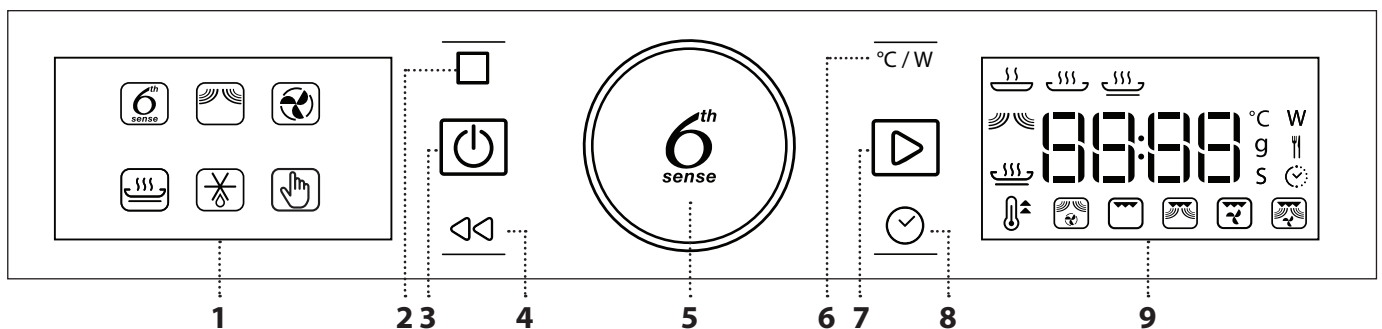

1. ÉCRAN AFFICHAGE GAUCHE

2. PAUSE

Pour interrompre un cycle de cuisson

3. MARCHE/ARRÊT

Pour allumer ou éteindre le four, et pour interrompre une fonction.

4. RETOUR

Pour retourner au menu précédent.

5. BOUTON ROTATIF / BOUTON 6th SENSE

Tournez pour sélectionner les fonctions et régler tous les paramètres de cuisson. Appuyez  pour sélectionner, régler, accéder et confirmer les fonctions ou les paramètres et lancer le programme de cuisson.

6. PUISSANCE

Pour régler la température, la puissance du gril ou du micro-ondes.

7. DÉMARRER

Pour lancer les fonctions et confirmer les réglages

8. HEURE

Pour régler le temps ainsi que pour régler ou ajuster le temps de cuisson.

9. ÉCRAN AFFICHAGE DROIT

ACCESSOIRES

PLAQUE TOURNANTE

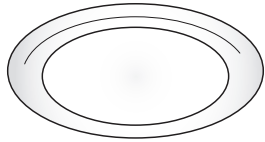

Installée sur son support, la plaque tournante en verre peut être utilisée avec toutes les méthodes de cuisson.

La plaque tournante doit toujours être utilisée comme

base pour les autres récipients ou accessoires, à l'exception de la plaque de cuisson rectangulaire.

SUPPORT DU PLATEAU TOURNANT

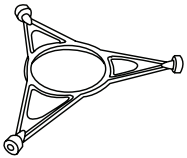

Utilisez le support uniquement pour la plaque tournante en verre. Ne placez pas d'autres accessoires sur le support.

PLAT CRISP

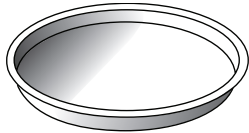

Utiliser seulement avec la fonction correspondante. Le plat Crisp doit être placé au centre de la plaque tournante en verre, et peut être préchauffé lorsqu'il est vide en utilisant

la fonction spéciale prévue à cet effet. Disposez les aliments directement sur le plat Crisp.

POIGNÉE POUR LE PLAT CRISP

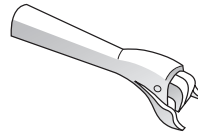

Utilisée pour retirer le plat Crisp chaud du four.

GRILLE MÉTALLIQUE

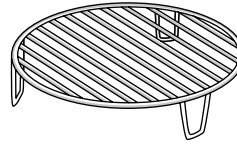

Elle vous permet de placer les aliments plus près de la grille pour un dorage parfait de votre plat. Placez la grille métallique sur la plaque tournante en vous assurant qu'elle ne touche pas

aux autres surfaces du compartiment.

PLAQUE DE CUISSON RECTANGULAIRE

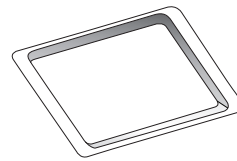

Utilisez la plaque à pâtisserie uniquement avec les fonctions pour la cuisson par convection ; elle ne doit jamais être utilisée avec la fonction four à micro-ondes.

Insérez la plaque à l'horizontale en la plaçant sur la grille du compartiment de cuisson.

Veillez noter: Vous n'avez pas besoin d'enlever la plaque tournante et son support lorsque vous utilisez la plaque à pâtisserie rectangulaire.

Le nombre et type d'accessoires peuvent varier selon le modèle acheté.

Pour les accessoires qui ne sont pas fournis, il est possible de les acheter séparément auprès du Service Après-Vente.

De nombreux accessoires sont disponibles sur le marché. Avant d'en acheter un, assurez-vous qu'il est adapté pour la cuisson au four à micro-ondes et qu'il est résistant à la chaleur du four.

Les récipients métalliques pour les aliments et les boissons ne devraient jamais être utilisés pour la cuisson au four à micro-ondes.

Toujours s'assurer que les aliments et les accessoires ne touchent pas aux parois internes du four.

Toujours vous assurer que la plaque tournante peut tourner librement avant de mettre l'appareil en marche. Assurez-vous de ne pas déplacer la plaque tournante lorsque vous insérez ou retirez des accessoires.

FONCTIONS



FONCTIONS 6th SENSE

Avec les fonctions 6th Sense, sélectionnez simplement le type et le poids, ou la quantité d'aliments, pour obtenir les meilleurs résultats. Le four détermine automatiquement les meilleurs réglages et les ajuste tout au long de la cuisson. La durée totale n'inclut pas les phases de préchauffage.

RECHAUFFAGE 6th SENSE

Pour réchauffer les repas préparés surgelés ou à la température de la pièce. Le four détermine automatiquement les réglages nécessaires pour les meilleurs résultats, le plus rapidement possible. Disposez les aliments sur un plat résistant à la chaleur et adapté au four à micro-ondes.

CATÉGORIE	ALIMENTS	POIDS
1	ASSIETTE À DÎNER	250 - 500 g
2*	PLAT SURGELÉ	250 - 500 g
3*	LASAGNES SURGELÉES	250 - 500 g
4	SOUPPES	200 - 800 g
5	BOISSONS	1 - 5 dl

CUISSON 6th SENSE

Pour cuire des aliments rapidement tout en obtenant d'excellents résultats. Utilisez un plat résistant à la chaleur allant au four à micro-ondes.

CATÉGORIE	ALIMENTS	POIDS
1	POMMES DE TERRES CUITES (Tournez lorsque vous y êtes invités)	200 g - 1 kg
2	LÉGUMES FRAIS (Coupez en morceaux de taille identique et ajoutez 2 à 4 cuillerées à soupe d'eau. Couvrir)	200 - 800 g
3*	LÉGUMES SURGELÉS (Tournez lorsque vous y êtes invité. Couvrir)	200 - 800 g
4	LÉGUMES EN CONSERVE	200 - 600 g
5	POPCORN	100 g

6th SENSE CRISP

Pour réchauffer et cuire rapidement les aliments surgelés, pour un dessus doré et croustillant. Seulement utiliser cette fonction avec le plat crisp fourni. Retournez les aliments lorsque qu'indiqué.

CATÉGORIE	ALIMENTS	POIDS
1*	Frites (étendre en une seule couche et saupoudrer de sel avant de les faire cuire)	200 - 600 g
2*	PIZZA, PÂTE FINE	200 - 500 g
3*	PIZZA, CROÛTE ÉPAISSE	300 - 800 g
4*	AILES DE POULET, MORCEAUX DE POULET (Huilez légèrement la plaque)	200 - 600 g
5*	BÂTONNETS DE POISSON (Le plat Crisp doit être préchauffé)	200 - 600 g

Accessoires nécessaires : Plat Crisp, poignée pour le plat Crisp



MICRO-ONDES

Pour rapidement cuire ou réchauffer des aliments ou des breuvages.

POWER	RECOMMANDÉE POUR
900 W	Rapidement réchauffez les boissons ou les aliments avec une forte teneur en eau
750 W	Cuisson de légumes
650 W	Cuisson de la viande et du poisson
500 W	Cuisson de sauces à la viande, ou les sauces contenant du fromage ou des œufs. Terminer la cuisson des pâtés à la viande et les pâtes cuites
350 W	Cuisson lente et délicate. Idéal pour faire fondre le beurre ou le chocolat
160 W	Décongélation des aliments surgelés ou ramollir le beurre et le fromage
90 W	Ramollissement de crèmes glacées



CHALEUR PULSEE

Pour cuire des plats de façon à obtenir des résultats comparables à la cuisson avec un four conventionnel. Vous pouvez utiliser la plaque à pâtisserie ou d'autre plat de cuisson résistant à la chaleur pour cuire certains aliments.

Accessoires recommandés : Plaque de cuisson rectangulaire, grille métallique



CRISP

Pour dorer un plat à la perfection, autant au-dessus qu'en dessous. Cette fonction doit être utilisée avec le plat Crisp spécial.

Accessoires nécessaires : Plat Crisp, poignée pour le plat Crisp



JET DEFROST

Pour rapidement décongeler différents types d'aliments en précisant leur poids. Placez les aliments directement sur la plaque tournante en verre. Retournez les aliments lorsque qu'indiqué.

CATÉGORIE	ALIMENTS	POIDS
1*	VIANDE (mince, côtelettes, biftecks, rôtis)	100 g - 2 kg
2*	VOLAILLE (poulet entier, morceaux, filets)	100 g - 2,5 kg
3*	POISSON (entier, darnes, filets)	100 g - 2 kg
4*	LÉGUMES (macédoine de légumes, petits pois, brocolis, etc.)	100 g - 2 kg
5*	PAIN (pains, petits pains, brioches)	100 g - 1 kg



FONCTIONS MANUELLES



PRÉCHAUFFAGE RAPIDE

Pour chauffer rapidement le four avant la cuisson. Attendez la fin de la fonction avant de placer les aliments dans le four.



CHALEUR PULSÉE + MO

Pour préparer des plats en peu de temps.

Accessoires nécessaires : grille métallique



GRIL

Pour dorer, griller, et gratiner. Nous vous conseillons de retourner les aliments durant la cuisson. Pour de meilleurs résultats, préchauffez le gril de 3 à 5 minutes.

Accessoires nécessaires : grille métallique



GRIL + MICRO-ONDES

Pour rapidement cuire et gratiner les plats en combinant les fonctions de four à micro-ondes et gril.

Accessoires nécessaires : grille métallique



TURBO GRIL

Pour des résultats parfaits en combinant les fonctions gril et convection. Nous vous conseillons de retourner les aliments durant la cuisson.

Accessoires nécessaires : grille métallique



TURBO GRIL + MO

Pour rapidement cuire et dorer vos aliments en combinant les fonctions de four à micro-ondes, gril, et convection.

Accessoires nécessaires : grille métallique

PREMIÈRE UTILISATION

. RÉGLAGE DE L'HEURE

Vous devez régler l'heure lorsque vous allumez l'appareil pour la première fois.



Les deux chiffres de l'heure clignotent : Tournez le bouton de réglage pour régler l'heure et ensuite appuyez sur pour confirmer.





Les deux chiffres des minutes clignotent. Tournez le bouton pour régler les minutes et appuyez sur pour confirmer.

Veillez noter: Pour changer l'heure plus tard, appuyez sur pour au moins une seconde alors que le four est éteint, et répétez les étapes décrites plus haut.

Vous pourriez avoir à régler l'heure à la suite d'une panne de courant prolongée.

UTILISATION QUOTIDIENNE

1. SÉLECTIONNER UNE FONCTION

Lorsque le four est éteint, seul l'heure est affichée à l'écran. Appuyez sur  pour allumer le four. Tournez le *bouton* pour afficher les principales fonctions disponibles sur l'écran de gauche. Sélectionnez une fonction et appuyez sur .

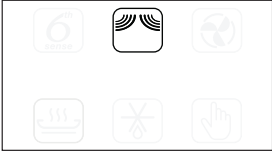

Pour sélectionner une sous-fonction (selon le modèle), sélectionnez la fonction principale et appuyez ensuite sur  pour confirmer et accéder au menu de la fonction.



Tournez le *bouton* pour sélectionner les sous-fonctions disponibles sur l'écran à droite puis appuyez sur  pour confirmer.



2. RÉGLAGE D'UNE FONCTION

. FONCTIONS AUTOMATIQUES/ JET DEFROST

CATÉGORIE D'ALIMENTS

Une fois que vous avez choisi une des fonctions automatiques, vous devrez sélectionner une catégorie pour les aliments que vous cuisez.





Quand l'  icône clignote, tournez le *bouton* pour sélectionner la catégorie que vous souhaitez, puis appuyez sur  pour confirmer.

POIDS

Pour atteindre les meilleurs résultats, les fonctions automatiques (et Jet Defrost) nécessitent que vous entriez le poids de l'aliment, en choisissant parmi les paramètres par défaut : le four calculera la durée idéale de fonctionnement de la fonction pour chaque catégorie d'aliment.





Quand le paramètre par défaut apparaît sur l'écran et que l'  icône clignote, tournez le *bouton* pour régler le poids, puis appuyez sur  pour confirmer.

. FONCTIONS MANUELLES

Après avoir sélectionné la fonction désirée, vous pouvez changer les réglages. L'écran affiche en séquence les réglages qui peuvent être changés.

PUISSANCE DU FOUR À MICRO-ONDES / TEMPÉRATURE



Lorsque le voyant  clignote sur l'écran, tournez le *bouton* pour ajuster la puissance et appuyez ensuite sur  pour confirmer et continuer de modifier les réglages qui suivent (si possible).

Veillez noter : Une fois que la fonction a été activée, la puissance peut être modifiée en appuyant sur  pour accéder au menu des réglages, puis en tournant le *bouton* pour modifier le réglage.

PUISSANCE DU GRIL



Il existe trois niveaux de puissance prédéfinis pour le gril : 1 (faible), 2 (moyenne), 3 (élevée). La valeur par défaut est affichée entre deux symboles "--" clignotants.



Tournez le *bouton* pour régler le niveau de gril souhaité, puis appuyez sur  pour confirmer.

DURÉE



Lorsque le voyant  clignote sur l'écran, utilisez le *bouton* pour régler le temps de cuisson désiré et ensuite appuyez sur  pour confirmer.

Vous n'avez pas à régler le temps de cuisson si vous avez l'intention de gérer la cuisson manuellement : Appuyez sur  pour confirmer et lancer la fonction.

Remarque : Pendant la cuisson, vous pouvez ajuster le temps de cuisson en tournant le *bouton* ; à chaque fois que vous appuyez sur , le temps de cuisson augmente de 30 secondes.

PRÉCHAUFFAGE RAPIDE

Sélectionnez la fonction, utilisez ensuite le *bouton* pour régler la température désirée et appuyez sur  pour confirmer et lancer la fonction.



Lorsque le four atteint la température cible, un signal sonore retentit.

Veillez noter: Nous vous conseillons de ne pas placer les aliments dans le four avant la fin de cette fonction.

3. ACTIVER LA FONCTION

Une fois que vous avez terminé les réglages, appuyez sur  pour lancer la fonction.

Chaque fois que vous appuyez sur la touche , la durée de cuisson augmente de 30 secondes supplémentaires.

Veillez noter: Vous pouvez appuyer sur  à tout moment pour interrompre la fonction en cours.

. JET START

Lorsque le four est éteint, vous pouvez appuyer sur  pour activer la cuisson avec la fonction four à micro-ondes à pleine puissance (900 W) pendant 30 secondes.

.VERROU DE SÉCURITÉ

Cette fonction est activée automatiquement pour empêcher d'allumer le four accidentellement.



Ouvrez et fermez la porte, appuyez ensuite sur  pour lancer la fonction.

4. PAUSE

Pour interrompre une fonction, pour brasser ou retourner les aliments par exemple, ouvrez simplement la porte.

Pour redémarrer la fonction, fermez la porte et appuyez sur .

INTERRUPTION AUTOMATIQUE (BRASSER OU TOURNER LES ALIMENTS)

Certaines fonctions vont s'interrompre pour vous permettre de tourner ou de brasser les aliments.



Une fois que la fonction est interrompue, ouvrez la porte et accomplissez l'action demandée avant de refermer la porte et appuyer sur  pour continuer la cuisson.

5. HEURE DE FIN DE CUISSON

Un signal sonore et l'écran indiquent la fin de la cuisson.



Pour prolonger le temps de cuisson sans changer les réglages, tournez le *bouton* pour choisir un nouveau temps de cuisson et appuyez sur .

. REFROIDISSEMENT

Lorsque la fonction avec air chaud est complétée, l'appareil exécute une procédure de refroidissement. L'écran affiche « Cool On (Refroidissement en cours) ». Après cette procédure, le four s'arrête automatiquement.

Veillez noter: la procédure de refroidissement peut être interrompue en ouvrant la porte et, le cas échéant, à nouveau activée en fermant la porte.

. VERROUILLAGE DES TOUCHES

Pour verrouiller les touches, appuyez sur  pour au moins 5 secondes.



Répétez pour déverrouiller le clavier.

Veillez noter: Le verrouillage peut aussi être activé pendant la cuisson.

Pour des raisons de sécurité, le four peut être arrêté à tout moment en appuyant sur la touche  et en la maintenant enfoncée.

TABLEAU DE CUISSON

ALIMENTS	FONCTION	PRÉCHAUFFER	TEMP. (°C)	PUISSANCE (W)	DURÉE	ACCESSOIRES
Gâteaux à pâte levée		-	160 - 180	-	30 - 60	
		-	160 - 180	90	25 - 50	
Tartes fourrées (gâteau au fromage, strudel, tarte aux pommes)		Oui	160-190	-	35 - 70	
Cookies		Oui	170-180	-	10 - 20	
Meringues		Oui	100-120	-	40 - 50	
Petits pains		Oui	210-220	-	10 - 12	
Pain		Oui	180-200	-	30 - 35	
Pizza / Tarte		Oui	190-220	-	20 - 40	
Pizza (0,4 - 0,5 kg)		-	-	-	14 - 16	
Tartes salées (tarte aux légumes, quiche lorraine)		Oui	180-190	-	40 - 55	
Quiche lorraine (1 - 1,2 kg)		-	-	-	18 - 20	
Lasagnes/pâtes au four		-	-	350 - 500	15 - 40	
Rôti d'agneau ou de veau / Rôti de bœuf (1,3 - 1,5 kg)		-	170-180	-	70 - 80*	
		-	160-180	160	50 - 70*	
Rôti de bœuf, à point (1,3 - 1,5 kg)		-	170-180	-	40 - 60*	
Poulet rôti/lapin/canard (entier 1-1,2 Kg)		-	210-220	-	50 - 70*	
		-	210-220	350	45 - 60*	
Poulet / lapin / canard (filets / morceaux 0,4 - 1 kg)		-	-	350 - 500	20 - 40*	
		-	-	-	12 - 18	
Poisson au four (entier)		-	-	160 - 350	20 - 40	
Filets/tranches de poisson		Oui	-	-	15 - 30*	
Légumes farcis (tomates, courgettes, aubergines...)		-	-	500 - 650	25 - 50	
Rôtie		-	-	-	3 - 6	
Saucisses / brochettes / côtes levées / hamburgers		-	-	-	20 - 40*	
Saucisses / hamburgers (0,2 - 1 kg)		Oui**	-	-	6 - 16	
Pommes de terre au four		-	-	350 - 500	20 - 40*	
Pommes de terre en quartier (0,3-0,8 Kg)		-	-	-	10 - 20	
Fruits cuits		-	-	160 - 350	15 - 25	
Légumes gratinés		-	-	-	15 - 25	
Légumes frits (0,3 - 0,8 kg)		Oui**	-	-	8 - 18	

* Retournez l'aliment à mi-cuisson.

** Préchauffez le plat Crisp de 3 à 5 minutes.

FONCTIONS	Crisp 	Chaleur pulsée 	Chaleur pulsée + MO 	Gril 	Gril + Micro-ondes
ACCESSOIRES	Plat résistant à la chaleur/récipient allant au four à micro-ondes 	Grille métallique 	Plaque de cuisson rectangulaire 	Plat Crisp 	

NETTOYAGE

Assurez-vous que l'appareil est froid avant de le nettoyer ou effectuer des travaux d'entretien.

N'utilisez pas de nettoyeur à vapeur.

N'utilisez pas de laine d'acier, de tampons à récurer abrasifs, ou des détergents abrasifs ou corrosifs, ils pourraient endommager les surfaces de l'appareil.

SURFACES INTÉRIEURES ET EXTÉRIEURES

- Nettoyez les surfaces à l'aide d'un chiffon en microfibre humide. Si elles sont très sales, ajoutez quelques gouttes de détergent à pH neutre. Essayez avec un chiffon sec.
- Nettoyez le verre dans la porte avec un détergent liquide approprié.
- À intervalles réguliers, ou en cas d'éclaboussures, enlevez la plaque tournante et son support pour nettoyer la base du four pour enlever tous les résidus d'aliment.
- Le gril n'a pas besoin d'être nettoyé, la chaleur intense brûle la saleté. Utilisez cette fonction de façon régulière.

ACCESSOIRES

Tous les accessoires conviennent au lave-vaisselle, sauf pour le plat Crisp. Nettoyez le plat Crisp avec de l'eau et un détergent doux. Pour les taches tenaces, frottez délicatement avec un chiffon. Laissez toujours refroidir le plat Crisp avant de le nettoyer.

GUIDE DE DÉPANNAGE

Problème	Cause possible	Solution
Le four ne fonctionne pas.	Coupure de courant. Débranchez de l'alimentation principale.	Assurez-vous qu'il n'y a pas de panne de courant et que le four est bien branché. Éteignez puis rallumez le four pour voir si le problème persiste.
Le four fait du bruit, même lorsqu'il est éteint.	Le ventilateur fonctionne.	Ouvrir la porte ou maintenir  .
L'écran affiche la lettre « F » suivie d'une lettre ou d'un chiffre.	Erreur de logiciel.	Contactez le Service après-vente le plus proche et mentionnez la lettre ou le numéro suivant la lettre « F ».

FICHE TECHNIQUE

 [www](http://www.docs.whirlpool.eu) La fiche technique, incluant les taux d'efficacité énergétique du four, peut être téléchargée sur notre site Web docs.whirlpool.eu

COMMENT OBTENIR LE GUIDE D'UTILISATION ET ENTRETIEN

>  [www](http://www.docs.whirlpool.eu) Téléchargez le Guide d'utilisation et d'entretien sur notre site Web docs.whirlpool.eu (vous pouvez utiliser ce code QR), en précisant le code commercial du produit.



> Une autre façon est de contacter notre Service Après-vente

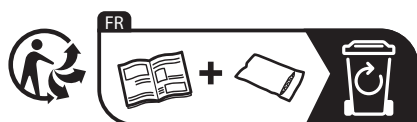

CONTACTER LE SERVICE APRÈS-VENTE

Vous pouvez trouver les informations pour nous contacter dans le livret de garantie. Lorsque vous contactez notre Service Après-vente, veuillez indiquer les codes disponibles sur la plaque signalétique de l'appareil.

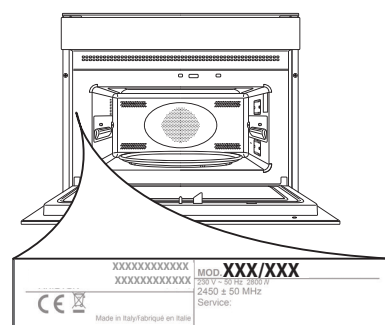

400011091756/B

Printed in Italy

KURZ ANLEITUNG



DANKE, DASS SIE SICH FÜR EIN WHIRLPOOL-PRODUKT ENTSCHEIDEN HABEN

Für eine umfassende Hilfe und Unterstützung, registrieren Sie Ihr Gerät bitte unter www.whirlpool.eu/register



Die Sicherheitshinweise und Gebrauchsanleitung können auf unserer Internetseite docs.whirlpool.eu heruntergeladen werden, bitte die Anweisungen auf der Rückseite des Heftes befolgen.



Lesen Sie vor Inbetriebnahme des Geräts sorgfältig die Sicherheitshinweise.

PRODUKTBESCHREIBUNG

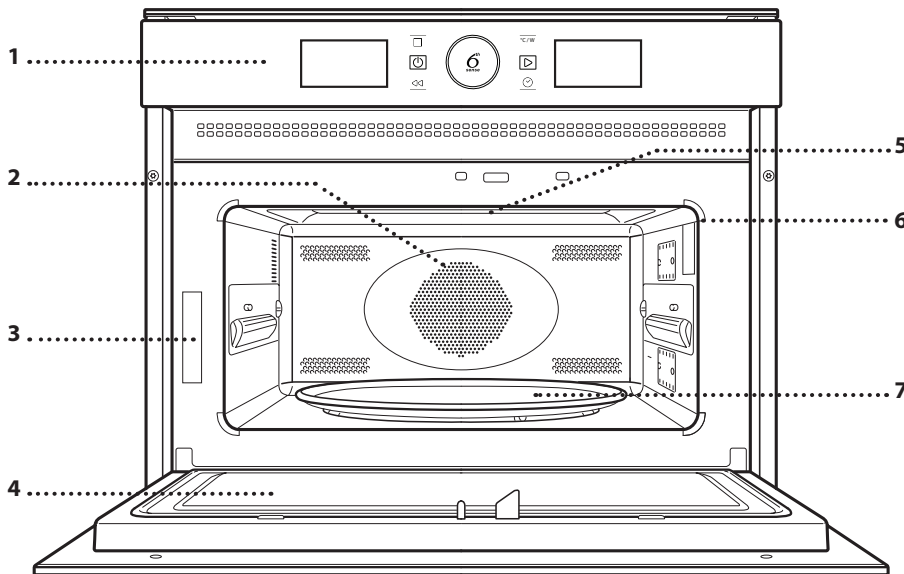

1. Bedienfeld
2. Ringheizelement (nicht sichtbar)
3. Typenschild (nicht entfernen)
4. Tür
5. Oberes Heizelement/Grill
6. Beleuchtung
7. Drehteller

BEDIENFELD

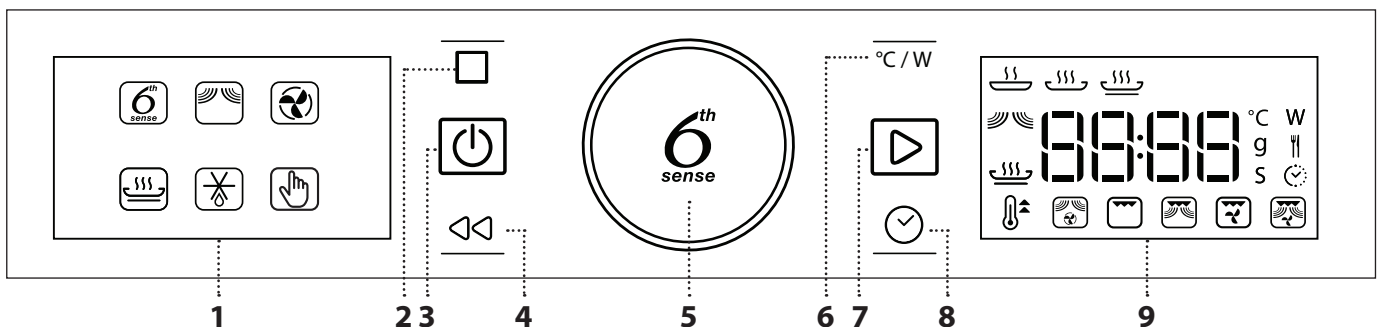

1. LINKES DISPLAY

2. PAUSE

Zum Unterbrechen eines Garzyklus

3. EIN/AUS

Zum Ein- und Ausschalten des Ofens und zum Stoppen einer aktiven Funktion zu einem beliebigen Zeitpunkt.

4. ZURÜCK

Für die Rückkehr zur vorherigen Ansicht.

5. DREHKNOPF / 6th SENSE-KNOPF

Drehen Sie diesen Knopf zum Durchlaufen der Funktionen und für die Einstellung aller Garparameter. Drücken Sie  für Auswahl, Einstellung, Zugriff auf oder Bestätigung von Funktionen oder Parametern und dann zum Starten des Garprogramms.

6. LEISTUNGSTUFE

Zum Einstellen von Temperatur, Grillstufe oder Mikrowellenleistung.

7. START

Für den Start von Funktionen und die Bestätigung von Einstellungen

8. ZEIT

Für die Einstellung sowie Änderung der Zeit und Anpassen der Garzeit.

9. RECHTES DISPLAY

ZUBEHÖRTEILE

DREHTELLER

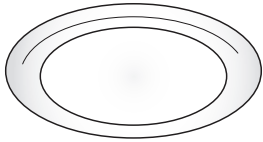

Auf seiner Auflage platziert, kann der Drehteller bei allen Garmethoden verwendet werden. Mit Ausnahme des rechteckigen Backblechs, muss der Drehteller

stets als Basis für andere Behälter oder Zubehörteile verwendet werden.

DREHTELLER AUFLAGE

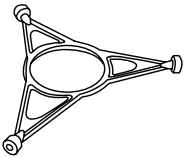

Die Auflage nur für den Glasdrehteller verwenden. Keine anderen Zubehörteile auf die Auflage stellen.

CRISP-PLATTE

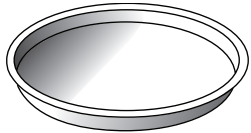

Nur für die Verwendung mit der vorgesehenen Funktion. Die Crisp-Platte immer in die Mitte des Glasdrehtellers stellen, sie kann in leerem Zustand durch Verwendung der Spezialfunktion,

die ausschließlich diesem Zweck dient, vorgeheizt werden. Legen Sie die Speise direkt auf die Crisp-Platte.

HALTEGRIFF FÜR DIE CRISP-PLATTE

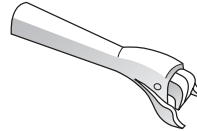

Zum Herausnehmen der heißen Crisp-Platte aus dem Ofen.

GRILLROST

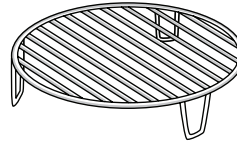

Dadurch kann die Speise, für eine perfekte Bräunung des Gerichts, näher an den Grill gestellt werden. Den Grillrost auf den Drehteller stellen und sicherstellen, dass er keine

anderen Flächen berührt.

RECHTECKIGES BACKBLECH

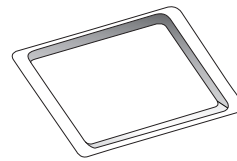

Das Backblech ausschließlich für Funktionen verwenden, die ein Umluftgaren ermöglichen; es darf niemals im Kombinationsbetrieb mit der Mikrowelle verwendet werden.

Das Backblech horizontal einsetzen, indem es auf den Rost im Garraum gestellt wird.

Bitte beachten: Bei der Verwendung des rechteckigen Backblechs müssen der Drehteller und seine Auflage nicht entfernt werden.

Die Anzahl und Art der Zubehörteile kann je nach gekauftem Modell variieren. Nicht mitgelieferte Zubehörteile sind separat über den Kundendienst erhältlich.

Eine Reihe von Zubehörteilen kann käuflich erworben werden. Vor dem Kauf überprüfen, ob sie für die Verwendung in der Mikrowelle geeignet und ofenfest sind.

Metallbehälter für Speisen oder Getränke dürfen niemals zum Mikrowellengaren verwendet werden.

Stets sicherstellen, dass Speisen und Zubehörteile die Innenseiten des Geräts nicht berühren.

Bevor Sie den Ofen einschalten, prüfen Sie stets, ob sich der Drehteller ungehindert drehen kann. Darauf achten, den Drehteller beim Einsetzen oder Entnehmen anderer Zubehörteile nicht abzunehmen.

FUNKTIONEN













6th SENSE-FUNKTIONEN

Bei den 6th Sense-Funktionen einfach die Art und das Gewicht oder die Menge der Lebensmittel auswählen, um beste Ergebnisse zu erhalten. Der Ofen berechnet automatisch die optimalen Einstellungen und ändert diese während den Garprozessen. Die Gesamtzeit schließt nicht die Vorheizphasen ein.











6th SENSE AUFWÄRMEN

Zum Aufwärmen von tiefgekühlten oder raumtemperierten Fertiggerichten. Der Ofen berechnet automatisch die Einstellungen für die bestmöglichen Ergebnisse in kürzester Zeit. Geben Sie das Gargut auf einen mikrowellengeeigneten und hitzebeständigen Essteller oder in ein entsprechendes Kochgeschirr.

KATEGORIE	SPEISE	GEWICHT
 	TELLERGERICHTE	250 – 500 g
 	GEFRORENE PORTIONEN	250 – 500 g
 	TIEFGEFR. LASAGNE	250 – 500 g
 	SUPPEN	200 – 800 g
 	GETRÄNKE	1 – 5 dl

6th SENSE GAREN

Für schnelles Garen von Lebensmitteln und für beste Ergebnisse. Hitzebeständige Platte/ mikrowellengeeigneter Behälter verwenden.

KATEGORIE	SPEISE	GEWICHT
 	OFENKARTOFFELN (Drehen, nach Aufforderung)	200 g - 1 kg
 	FRISCHES GEMÜSE (In gleich große Stücke geschnitten und 2 bis 4 Teelöffel Wasser zugefügt. Abdeckhaube)	200 – 800 g
 	TIEFGEFR. GEMÜSE (Drehen, nach Aufforderung. Abdeckhaube)	200 - 800 g
 	DOSEN GEMÜSE	200 - 600 g
 	POPCORN	100 g

6th SENSE CRISP

Zum schnellen Aufwärmen und Garen von tiefgekühlten Speisen für eine goldene Farbe und knusprige Oberfläche. Diese Funktion nur mit der mitgelieferten Crisp-Platte verwenden. Wenden Sie die Speise nach Aufforderung.

KATEGORIE	SPEISE	GEWICHT
 	POMMES FRITES (gleichmäßig verteilen und vor dem Garen mit Salz bestreuen)	200 - 600 g
 	PIZZA, DÜNNER BODEN	200 – 500 g
 	PIZZA, DICKER BODEN	300 – 800 g
 	HÄHNCHENFLÜGEL, HÄHNCHENTEILE (Den Teller leicht einölen)	200 - 600 g
 	FISCHSTÄBCHEN (Crisp-Platte muss vorgeheizt sein)	200 – 600 g

Erforderliche Zubehörteile: **Crisp-Platte, Haltegriff für die Crisp-Platte**

MIKROWELLE

Zum schnellen Garen und Aufwärmen von Speisen und Getränken.

LEISTUNGSSTUFE	EMPFOHLEN FÜR
900 W	Schnelles Aufwärmen von Getränken oder anderen Speisen mit einem hohen Wassergehalt
750 W	Garen von Gemüse
650 W	Garen von Fleisch und Fisch
500 W	Garen von Fleischsoßen, käse- oder eierhaltigen Soßen. Fertiggaren von Fleischpasteten oder Nudelauflauf
350 W	Langsames, schonendes Garen. Perfekt zum Schmelzen von Butter oder Schokolade
160 W	Auftauen tiefgekühlter Speisen oder Aufweichen von Butter und Käse
90 W	Aufweichen von Eiscreme

HEISSLUFT

Zum Garen von Speisen mit ähnlichen Ergebnissen eines herkömmlichen Ofens. Das Backblech oder anderes ofenfestes Kochgeschirr kann zum Garen bestimmter Speisen verwendet werden.

Empfohlene Zubehörteile: **Rechteckiges Backblech, Grillrost**



CRISP

Zum perfekten Bräunen des Gerichts, sowohl auf der Oberseite als auch auf der Unterseite der Speise. Diese Funktion darf nur mit der speziellen Crisp-Platte verwendet werden.

Erforderliche Zubehörteile: Crisp-Platte, Haltegriff für die Crisp-Platte



JET DEFROST

Zum schnellen Auftauen verschiedener Speisen, einfach durch Angabe ihres Gewichts. Die Speise muss direkt auf den Glasdrehteller gestellt werden. Wenden Sie die Speise nach Aufforderung.

KATEGORIE	SPEISE	GEWICHT
1*	FLEISCH (Gehacktes, Koteletts, Steaks, Bratenstücke)	100 g – 2 kg
2*	GEFLÜGEL (ganze Hähnchen, Hähnchenstücke, Hähnchenfilets)	100 g - 2,5 kg
3*	FISCH (ganzer Fisch, Fischsteaks, Fischfilets)	100 g – 2 kg
4*	GEMÜSE (Mischgemüse, Erbsen, Brokkoli usw.)	100 g – 2 kg
5*	BROT (Brotlaibe, süße Teilchen oder Brötchen)	100 g – 1 kg



MANUELLE FUNKTIONEN



SCHNELLAUFHEIZEN

Zum Schnellaufheizen des Ofens vor einem Garzyklus. Das Ende der Funktion abwarten, bevor die Speise in den Ofen gestellt wird.



HEISSLUFT + MW

Für die schnelle Zubereitung von Ofengerichten.

Erforderliche Zubehörteile: Grillrost



GRILL

Zum Bräunen, Grillen und Gratinieren. Es wird empfohlen, die Speise während dem Garen zu wenden. Für optimale Ergebnisse, den Grill für 3 -5 Minuten vorheizen.

Erforderliche Zubehörteile: Grillrost



GRILL + MW

Zum schnellen Garen und Gratinieren von Gerichten durch Kombination der Mikrowellen- und Grillfunktionen.

Erforderliche Zubehörteile: Grillrost



TURBOGRILL

Für optimale Ergebnisse durch Kombination der Grill- und Umluftfunktionen. Es wird empfohlen, die Speise während dem Garen zu wenden.

Erforderliche Zubehörteile: Grillrost



TURBOGRILL + MW

Zum schnellen Garen und Bräunen von Speisen durch Kombination der Mikrowellen-, Grill- und Umluftfunktionen.

Erforderliche Zubehörteile: Grillrost

ERSTER GEBRAUCH

. EINSTELLUNG DER UHRZEIT

Wenn das Gerät zum ersten Mal eingeschaltet wird, muss die Zeit eingestellt werden.



Die beiden Ziffern für die Stunden beginnen zu blinken: Den *Knopf* drücken, um die korrekte Uhrzeit einzustellen und zur Bestätigung drücken.





Die beiden Ziffern für die Minuten beginnen zu blinken. Den *Knopf* drehen, um die Minuten einzustellen und zur Bestätigung drücken.

Bitte beachten: Zur Änderung der Zeit zu einem späteren Zeitpunkt, für mindestens eine Sekunde bei ausgeschaltetem Ofen gedrückt halten und die oben stehenden Schritte wiederholen.

Nach einem längeren Stromausfall muss die Zeit unter Umständen erneut eingestellt werden.

TÄGLICHER GEBRAUCH

1. AUSWÄHLEN EINER FUNKTION

Bei ausgeschaltetem Ofen wird nur die Zeit auf dem Display angezeigt. Die Taste  gedrückt halten, um den Ofen einzuschalten. Den *Knopf* drehen, um die auf dem linken Display verfügbaren Hauptfunktionen anzuzeigen. Eine Funktion auswählen und  drücken.

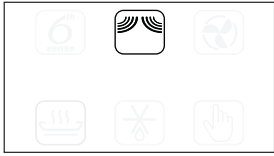

Zur Auswahl einer Unterfunktion (sofern verfügbar), die Hauptfunktion auswählen, anschließend  zur Bestätigung drücken und zum Funktionsmenü gehen.



Den *Knopf* drücken, um unter verfügbaren Unterfunktionen auf der rechten Anzeigenseite zu wählen und mit  bestätigen.



2. EINE FUNKTION EINSTELLEN

. AUTOMATIKFUNKTIONEN/JET DEFROST

LEBENSMITTELKATEGORIE

Sobald Sie eine der Automatikfunktionen ausgewählt haben, müssen Sie eine Kategorie für die zu garenden Lebensmittel auswählen.





Wenn das Symbol  blinkt, den *Knopf* drehen, um die gewünschte Kategorie auszuwählen und mit  bestätigen.

GEWICHT

Um beste Ergebnisse zu erreichen, müssen Sie für die Automatikfunktionen (und Jet Defrost) das Gewicht des Lebensmittels eingeben, das Sie unter den werkseitigen Einstellungen auswählen können: der Ofen berechnet die ideale Zeitdauer für die zu verwendende Funktion für jede Lebensmittelkategorie.



Wenn die werkseitige Einstellung auf der Anzeige erscheint und das Symbol  blinkt, den *Knopf* drehen, um das Gewicht einzustellen und mit  bestätigen.

. MANUELLE FUNKTIONEN

Nach Auswahl der gewünschten Funktion, können Sie die Einstellungen ändern. Das Display zeigt die Einstellungen an, die nacheinander geändert werden können.

MIKROWELLENLEISTUNGSSTUFE / TEMPERATUR



Wenn das Symbol **W** auf dem Display blinkt, den *Knopf* drehen, um die Leistungsstufe zu ändern; dann mit  bestätigen und die folgenden Einstellungen ändern (wenn möglich).

Bitte beachten: Wenn die Funktion aktiviert wurde, kann die Leistung geändert werden durch Drücken von , um das Einstellungsmenü aufzurufen, dann den *Knopf* drehen, um die Einstellung zu ändern.

GRILLSTUFE

Es gibt drei feste Temperaturstufen für das Grillen: 1 (niedrig), 2 (mittel), 3 (hoch). Der Standardwert wird zwischen zwei blinkenden "- -" Symbolen angezeigt.



Drehen Sie den *Knopf*, um die gewünschte Grillstufe einzustellen. Drücken Sie  zum Bestätigen.

DAUER



Wenn das Symbol  auf dem Display blinkt, den *Knopf* zum Einstellen der gewünschten Garzeit verwenden, und anschließend  zur Bestätigung drücken.

Die Garzeit muss nicht eingestellt werden, wenn der Garvorgang manuell gehandhabt wird: Drücken Sie  zum Bestätigen und Starten der Funktion.

Hinweis: Während dem Garen können Sie die Garzeit durch Drehen des *Knopfes* anpassen; Bei jedem Drücken von  wird die Garzeit um 30 Sekunden verlängert.

SCHNELLAUFHEIZEN

Wählen Sie die Funktion an und verwenden Sie den *Knopf*, um die gewünschte Temperatur einzustellen. Dann auf  drücken, um die Auswahl zu bestätigen und die Funktion zu starten.



Wenn der Backofen die Zieltemperatur erreicht hat, ertönt ein Summer.

Bitte beachten: Wir empfehlen, die Speisen nicht vor Ablauf dieser Funktion in den Ofen zu geben.

3. DIE FUNKTION AKTIVIEREN

Nachdem die erforderlichen Einstellungen getätigt wurden,  drücken, um die Funktion zu aktivieren.

Bei jedem erneuten Tastendruck der Taste , wird die Garzeit um weitere 30 Sekunden erhöht.

Bitte beachten: Die aktive Funktion kann jederzeit durch Drücken von  gestoppt werden.

. JET START

Bei ausgeschaltetem Ofen, kann  zur Aktivierung des Garvorgangs bei voller Leistungsstufe der Mikrowellenfunktion (900 W) für 30 Sekunden gedrückt werden.

. SICHERHEITSSPERRE

Diese Funktion wird automatisch aktiviert, um ein versehentliches Einschalten des Ofens zu vermeiden.



Die Tür öffnen und schließen und anschließend  zum Start der Funktion drücken.

4. PAUSE

Zum Unterbrechen einer aktiven Funktion, z.B. zum Umrühren oder Wenden der Speise, einfach die Tür öffnen.

Zum Fortsetzen der Funktion, die Tür schließen und  drücken.

AUTOMATISCHE PAUSE

(RÜHREN SIE DAS GARGUT UM ODER WENDEN SIE ES)

Gewisse Funktionen halten den Garvorgang an, damit Sie die Speise wenden oder umrühren können.

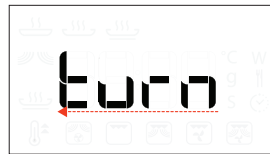

Sobald der Backofen das Garen anhält, die Tür öffnen und die aufgeforderte Aktivität durchführen, bevor Sie die Tür erneut schließen und  drücken, um mit dem Garen fortzufahren.

5. ENDE DER GARZEIT

Es ertönt ein akustisches Signal und das Display zeigt an, dass der Garvorgang beendet ist.



Zur Verlängerung der Garzeit ohne Änderung der Einstellungen, den *Knopf* zum Einstellen einer neuen Garzeit drehen und  drücken.

. ABKÜHLEN

Nach der Beendigung einer Heißluftfunktion startet das Gerät unter Umständen einen Abkühlvorgang. Auf dem Display erscheint „Cool On“. Danach schaltet sich das Gerät automatisch ab.

Bitte beachten: Der Abkühlvorgang kann durch Öffnen der Tür unterbrochen werden und wird beim erneuten Schließen bei Bedarf wieder eingeschaltet.

. TASTENSPERRE

Zum Sperren der Tastatur, die Taste  mindestens 5 Sekunden gedrückt halten.













































Dies erneut zum Entsperren der Tastatur ausführen.

Bitte beachten: Die Tastensperre kann auch bei laufendem Garvorgang aktiviert werden.

Aus Sicherheitsgründen kann der Ofen jederzeit durch Drücken und Halten der Taste  ausgeschaltet werden.

GARTABELLE

SPEISE	FUNKTION	VORHEIZEN	TEMP. (°C)	LEISTUNGSSTUFE (W)	DAUER	ZUBEHÖRTEILE
Hefekuchen		-	160 - 180	-	30 - 60	
		-	160 - 180	90	25 - 50	
Gefüllter Kuchen (Käsekuchen, Strudel, Obstkuchen)		Ja	160-190	-	35 - 70	
Kekse		Ja	170-180	-	10 - 20	
Meringue		Ja	100-120	-	40 - 50	
Brötchen		Ja	210-220	-	10 - 12	
Brotlaib		Ja	180-200	-	30 - 35	
Pizza / Quiche		Ja	190-220	-	20 - 40	
Pizza (0,4 - 0,5 kg)		-	-	-	14 - 16	
Herzhafte Torten (Gemüsetorte, Quiche Lorraine)		Ja	180-190	-	40 - 55	
Quiche Lorraine (1 - 1,2 kg)		-	-	-	18 - 20	
Lasagne / Überbackene Nudelgerichte		-	-	350 - 500	15 - 40	
Lammbraten/Kalbsbraten/Roastbeef (1,3 - 1,5 kg)		-	170-180	-	70 - 80*	
		-	160-180	160	50 - 70*	
Roastbeef – Mittel (1,3 - 1,5 kg)		-	170-180	-	40 - 60*	
Brathähnchen / Kaninchen / Ente (ganz 1-1,2 kg)		-	210-220	-	50 - 70*	
		-	210-220	350	45 - 60*	
Hähnchen / Kaninchen / Ente (Filets/Stücke 0,4-1 kg)		-	-	350 - 500	20 - 40*	
		-	-	-	12 - 18	
Gebackener Fisch (ganz)		-	-	160 - 350	20 - 40	
Fischfilets/Scheiben		Ja	-	-	15 - 30*	
Gefülltes Gemüse (Tomaten, Zucchini, Auberginen...)		-	-	500 - 650	25 - 50	
Toast		-	-	-	3 - 6	
Bratwürste / Grillspieße / Rippchen / Hamburger		-	-	-	20 - 40*	
Bratwurst/Hamburger (0,2 - 1 kg)		Ja**	-	-	6 - 16	
Ofenkartoffeln		-	-	350 - 500	20 - 40*	
Kartoffelecken (0,3 - 0,8 kg)		-	-	-	10 - 20	
Backobst		-	-	160 - 350	15 - 25	
Gemüsegratin		-	-	-	15 - 25	
Gebratenes Gemüse (0,3 g - 0,8 kg)		Ja**	-	-	8 - 18	

* Die Speise nach halber Garzeit wenden.

** Die Crisp-Platte für 3–5 Minuten vorheizen.

FUNKTIONEN	Crisp 	Heißluft 	Heißluft + MW 	Grill 	Grill + MW 
ZUBEHÖRTEILE	Hitzebeständige Platte/ geeigneter Behälter für die Verwendung in Mikrowellen 	Grillrost 	Rechteckiges Backblech 	Crisp-Platte 	

REINIGUNG

Vor dem Ausführen beliebiger Wartungs- oder Reinigungsarbeiten sicherstellen, dass das Gerät abgekühlt ist.

Keine Dampfreiniger verwenden.

Keine Stahlwolle, Scheuermittel oder aggressive/ätzende Reinigungsmittel verwenden, da diese die Flächen des Gerätes beschädigen können.

INNEN- UND AUSSENFLÄCHEN

- Reinigen Sie die Flächen mit einem feuchten Mikrofasertuch. Sollten sie stark verschmutzt sein, einige Tropfen von pH-neutralem Reinigungsmittel verwenden. Reiben Sie mit einem trockenen Tuch nach.
- Das Glas der Backofentür mit einem geeigneten Flüssigreiniger reinigen.
- In regelmäßigen Abständen oder beim Verschütten von Speisen, den Drehteller und seine Auflage zur Reinigung des Gerätebodens abnehmen und alle Speiserückstände entfernen.
- Der Grill muss nicht gereinigt werden, da die starke Hitze Verschmutzungen verbrennt. Diese Funktion regelmäßig verwenden.

ZUBEHÖRTEILE

Alle Zubehörteile, mit Ausnahme der Crisp-Platte, sind spülmaschinenfest. Die Crisp-Platte darf nur mit Wasser und mildem Reinigungsmittel gereinigt werden. Hartnäckige Verschmutzungen durch sanftes Scheuern mit einem Tuch entfernen. Die Crisp-Platte vor dem Reinigen immer erst abkühlen lassen.

LÖSEN VON PROBLEMEN

Problem	Mögliche Ursache	Abhilfemaßnahme
Der Ofen funktioniert nicht.	Stromausfall. Trennung von der Stromversorgung.	Überprüfen, ob das Stromnetz Strom führt und der Backofen an das Netz angeschlossen ist. Schalten Sie den Backofen aus und wieder ein, um festzustellen, ob die Störung erneut auftritt.
Beim Ausschalten des Ofens produziert dieser Geräusche.	Kühlgebläse aktiv.	Tür öffnen oder  drücken.
Das Display zeigt ein „F“ gefolgt von einem Buchstaben oder einer Nummer an.	Softwarefehler.	Den nächsten Kundendienst kontaktieren und den Buchstaben oder die Nummer nach dem Buchstaben „F“ angeben.

TECHNISCHE DATEN

 [www](http://www.docs.whirlpool.eu) Die technischen Daten mit Angabe der Energiedaten für dieses Gerät können auf der Internetseite docs.whirlpool.eu heruntergeladen werden

WIE IST DIE GEBRAUCHSANLEITUNG ERHÄLTlich?

>  [www](http://www.docs.whirlpool.eu) Die Gebrauchsanleitung von der Internetseite docs.whirlpool.eu herunterladen (den QR-Code verwenden) durch Angabe des Produkthandelscodes.

> Alternativ unseren Kundendienst kontaktieren



UNSEREN KUNDENDIENST KONTAKTIEREN

Unsere Kontaktdaten sind im Garantiehandbuch zu finden. Wird der Kundendienst kontaktiert, bitte die Codes auf dem Typenschild des Produkts angeben.

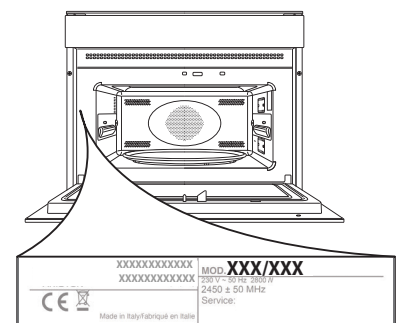

400011091756/B

Printed in Italy

GUIDA RAPIDA



GRAZIE PER AVER ACQUISTATO UN PRODOTTO WHIRLPOOL

Per ricevere un'assistenza più completa, registrare il prodotto su www.whirlpool.eu/register



Scaricare le istruzioni per la sicurezza e le istruzioni per l'uso collegandosi al sito docs.whirlpool.eu e seguire la procedura indicata sul retro.

! Leggere attentamente le istruzioni per la sicurezza prima di utilizzare il prodotto.

DESCRIZIONE PRODOTTO

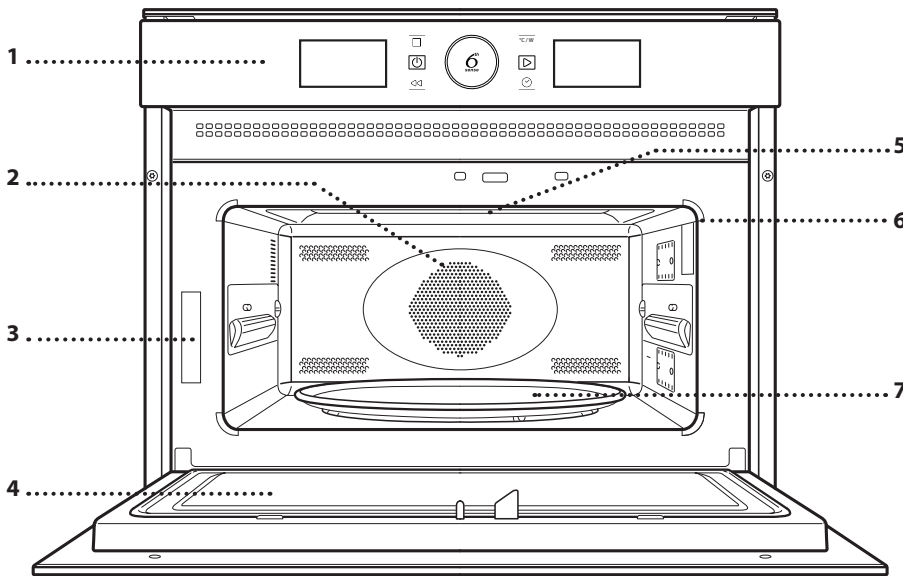

1. Pannello di controllo
2. Resistenza circolare (non visibile)
3. Targhetta matricola (da non rimuovere)
4. Porta
5. Resistenza superiore / grill
6. Luce
7. Piatto rotante

PANNELLO COMANDI

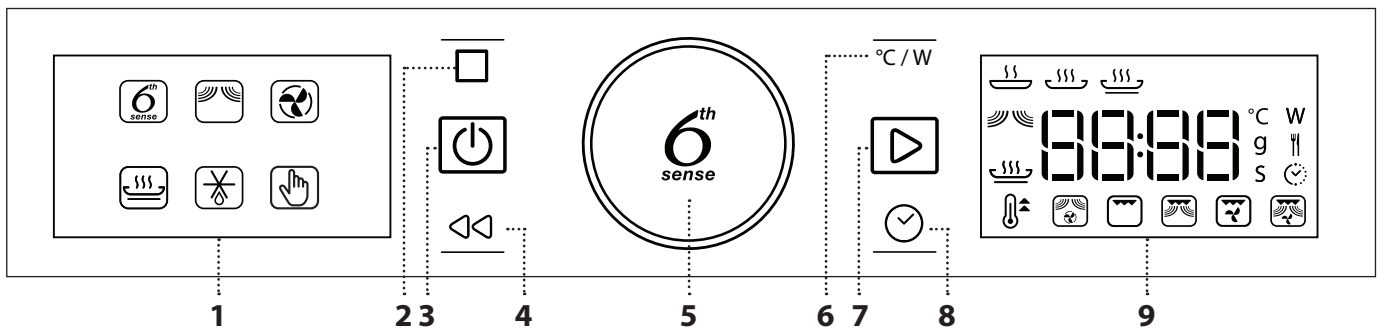

1. PARTE SINISTRA DEL DISPLAY

2. PAUSA

Per sospendere il processo di cottura

3. ON / OFF

Per accendere e spegnere il forno o terminare in qualunque momento una funzione attiva.

4. INDIETRO

Per tornare alla schermata precedente.

5. MANOPOLA GIREVOLE / TASTO 6th SENSE

Ruotando la manopola è possibile spostarsi tra le funzioni e regolare i parametri di cottura. Premere  per selezionare, impostare, visualizzare e confermare le funzioni o i parametri e per avviare i programmi di cottura.

6. POTENZA

Per regolare la temperatura, la potenza del grill o l'intensità delle microonde.

7. START

Per avviare le funzioni e confermare i valori impostati

8. TEMPO

Per impostare l'ora e per regolare il tempo di cottura.

9. PARTE DESTRA DEL DISPLAY

ACCESSORI

PIATTO ROTANTE

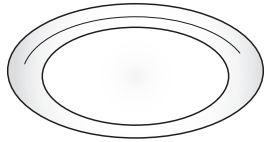

Appoggiato sull'apposito supporto, il piatto rotante in vetro può essere utilizzato in tutte le modalità di cottura. Il piatto rotante va sempre usato come base per altri contenitori o

accessori ad eccezione della teglia rettangolare.

SUPPORTO PER PIATTO ROTANTE

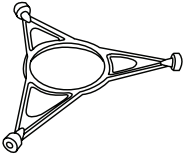

Utilizzare il supporto soltanto per il piatto rotante in vetro. Non appoggiare altri accessori sul supporto.

PIATTO CRISP

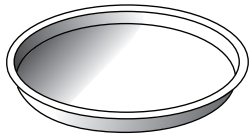

Da utilizzare solo con la funzione designata. Il piatto Crisp deve essere sempre appoggiato al centro del piatto rotante in vetro e può essere preriscaldato a vuoto, utilizzando

solo la speciale funzione dedicata. Disporre gli alimenti direttamente sul piatto Crisp.

MANIGLIA PER PIATTO CRISP

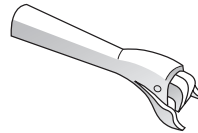

Utile per rimuovere il piatto Crisp caldo dal forno.

GRIGLIA

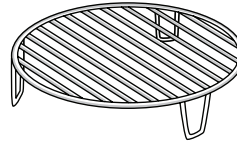

Permette di avvicinare il cibo al grill, assicurandone una piacevole doratura. Appoggiare la griglia sul piatto rotante, evitando che venga a contatto con altre superfici.

TEGLIA RETTANGOLARE

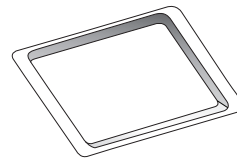

Utilizzare la teglia soltanto con le funzioni che consentono la cottura ventilata; non usarla mai in combinazione con le microonde.

Inserirla orizzontalmente, appoggiandola sopra l'apposita guida nella cavità.

Nota: non è necessario togliere il piatto rotante e il suo supporto durante l'utilizzo della teglia rettangolare.

Il numero e il tipo di accessori può variare a seconda del modello acquistato.

È possibile acquistare separatamente altri accessori non in dotazione presso il Servizio Assistenza Clienti.

In commercio sono disponibili diversi accessori. Prima di acquistarli, accertarsi che siano idonei alla cottura a microonde e alle temperature del forno.

Contenitori metallici per cibi o bevande non vanno mai usati durante una cottura a microonde.

Verificare che alimenti e accessori non tocchino le pareti interne del forno.

Prima di avviare il forno, assicurarsi sempre che il piatto rotante possa ruotare liberamente. Fare attenzione a non spostare il piatto rotante dalla sua sede mentre si inseriscono o rimuovono altri accessori.

FUNZIONI



FUNZIONI 6th SENSE

Con le funzioni 6th Sense è sufficiente selezionare il tipo e il peso o la quantità degli alimenti per ottenere un risultato ottimale. Il forno calcolerà automaticamente i valori ideali, adattandosi continuamente alla cottura in corso. La durata totale non include le fasi di preriscaldamento.

RISCALDAMENTO 6th SENSE

Per riscaldare cibi pronti, sia surgelati che a temperatura ambiente. Il forno calcolerà automaticamente i valori necessari per ottenere i migliori risultati possibili nel minor tempo. Disporre il cibo su un piatto da portata resistente al calore e alle microonde.

CATEGORIA	ALIMENTO	PESO
	PIATTI PRONTI	250 - 500 g
	SURGELATI MONOPORZIONE	250 - 500 g
	LASAGNE SURGELATE	250 - 500 g
	MINESTRE	200 - 800 g
	BEVANDE	1 - 5 dl

COTTURA 6th SENSE

Per ottenere una rapida e ottimale cottura degli alimenti. Utilizzare un contenitore resistente al calore e adatto alla cottura a microonde.

CATEGORIA	ALIMENTO	PESO
	PATATE AL FORNO (girare quando viene richiesto)	200 g - 1 kg
	VERDURE FRESCHE (tagliare a pezzi di pari dimensioni e aggiungere da 2 a 4 cucchiai di acqua. Coprire)	200 - 800 g
	VERDURE SURGELATE (girare quando richiesto. Coprire)	200 - 800 g
	VERDURE IN SCATOLA	200 - 600 g
	POPCORN	100 g

CRISP 6th SENSE

Per riscaldare e cuocere rapidamente alimenti surgelati, creando una superficie dorata e croccante. Usare la funzione solo in combinazione con il piatto Crisp in dotazione. Quando richiesto, girare gli alimenti.

CATEGORIA	ALIMENTO	PESO
	PATATINE FRITTE (disposte in un unico strato e salate prima della cottura)	200 - 600 g
	PIZZA, CROSTA SOTTILE	200 - 500 g
	PIZZA, CROSTA SPessa	300 - 800 g
	ALI DI POLLO, PEZZI DI POLLO (ungere leggermente il piatto)	200 - 600 g
	BASTONCINI DI PESCE (il piatto Crisp deve essere preriscaldato)	200 - 600 g

Accessori necessari: **piatto crisp, maniglia per piatto crisp**

MICROONDE

Per cuocere e riscaldare rapidamente alimenti o bevande.

POTENZA	CONSIGLIATA PER
900 W	Riscaldamento rapido di bevande o altri alimenti ad alto contenuto di acqua
750 W	Cottura di vegetali
650 W	Cottura di carne e pesce
500 W	Cottura di sughi di carne, salse con formaggio o uova. Finitura di sformati di carne o paste al forno
350 W	Cotture lente e delicate. Per fondere burro o cioccolato
160 W	Scongela alimenti surgelati o ammorbidire burro e formaggi
90 W	Ammorbidire il gelato

TERMOVENTILATO

Per cuocere le pietanze con risultati analoghi a quelli di un forno statico. Per la cottura di alcuni alimenti è possibile usare la teglia o utilizzare recipienti adatti alla cottura in forno.

Accessori consigliati: **Teglia rettangolare, griglia**



CRISP

Per ottenere una doratura perfetta sia sulla superficie superiore che su quella inferiore del cibo. Questa funzione deve essere usata solo con lo speciale piatto Crisp.

Accessori necessari: piatto crisp, maniglia per piatto crisp



JET DEFROST

Per scongelare rapidamente diverse categorie di alimenti specificandone solamente il peso. Si consiglia di disporre gli alimenti direttamente sul piatto rotante in vetro. Quando richiesto, girare gli alimenti.

CATEGORIA	ALIMENTO	PESO
1*	CARNE (macinato, cotolette, bistecche, arrosti)	100 g - 2 kg
2*	POLLAME (pollo intero, a pezzi, filetti)	100 g - 2,5 kg
3*	PESCE (Intero, tranci, filetti)	100 g - 2 kg
4*	VERDURE (Verdure miste, piselli, broccoli...)	100 g - 2 kg
5*	PANE (Pagnotte, focaccine, panini)	100 g - 1 kg



FUNZIONI MANUALI



RISCALDAMENTO RAPIDO

Per riscaldare rapidamente il forno prima di un ciclo di cottura. Attendere il termine della funzione prima di inserire gli alimenti nel forno.



VENTILATO + MICROONDE

Per preparare pietanze al forno in breve tempo.

Accessori necessari: griglia



GRILL

Per dorare, grigliare o gratinare le pietanze. Si consiglia di girare gli alimenti durante la cottura. Si raccomanda di preriscaldare il grill per 3-5 minuti.

Accessori necessari: griglia



GRILL + MICROONDE

Per cuocere e gratinare rapidamente le pietanze combinando le microonde con il grill.

Accessori necessari: griglia



TURBO GRILL

Per risultati perfetti, combinando l'azione del grill e del forno ventilato. Si consiglia di girare gli alimenti durante la cottura.

Accessori necessari: griglia



TURBO GRILL + MICROONDE

Per cuocere e dorare velocemente il cibo combinando l'azione delle microonde, del grill e del forno ventilato.

Accessori necessari: griglia

PRIMO UTILIZZO

. IMPOSTARE L'ORA

Alla prima accensione è necessario impostare l'ora.



Sul display lampeggiano le due cifre relative alle ore: Ruotare la *manopola* per impostare l'ora desiderata e premere per confermare.





Sul display lampeggiano le due cifre relative ai minuti. ruotare la *manopola* per impostare i minuti e premere per confermare.

Nota: per modificare successivamente l'ora, a forno spento tenere premuto per almeno 1 secondo e ripetere le operazioni sopra descritte.

Dopo una prolungata interruzione di corrente potrebbe essere necessario impostare nuovamente l'ora.

USO QUOTIDIANO

1. SELEZIONARE UNA FUNZIONE

Quando il forno è spento, è visualizzato solo l'orologio: tenere premuto  per accendere il forno. Ruotare la *manopola* per visualizzare sul display sinistro le funzioni principali disponibili e premere  per confermare.

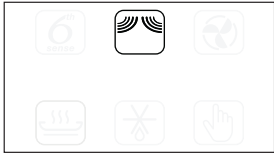

Dove presente, per selezionare una sottofunzione, dopo aver selezionato la funzione principale, premere  per confermare e accedere al menu delle funzioni.



Ruotare la *manopola* per selezionare le sottofunzioni disponibili sul display di destra e premere  per confermare.

2. SELEZIONARE UNA FUNZIONE

. FUNZIONI AUTOMATICHE / JET DEFROST

CATEGORIA DI ALIMENTO

Dopo avere selezionato una funzione automatica, occorre selezionare la categoria di alimenti appropriata.



Quando l' '1' icona lampeggia, ruotare la *manopola* per selezionare la categoria desiderata e premere  per confermare.

PESO

Per ottenere risultati ottimali con le funzioni automatiche (e Jet Defrost), è necessario inserire il peso degli alimenti scegliendo tra le impostazioni predefinite: il forno calcolerà la durata ideale della funzione per la categoria di alimenti selezionata.



Quando sul display compaiono le impostazioni predefinite e l' '9' icona lampeggia, ruotare la *manopola* per impostare il peso e premere  per confermare.

. FUNZIONI MANUALI

Dopo avere selezionato la funzione desiderata è possibile modificare i valori. Il display mostra in sequenza i valori che è possibile modificare.

POTENZA MICROONDE / TEMPERATURA



Quando l'icona W lampeggia sul display, ruotare la *manopola* per regolare il livello di potenza, quindi premere  per confermare e procedere con le impostazioni seguenti (se possibile).

Nota: dopo avere attivato la funzione, la potenza può essere modificata premendo  per accedere al menu delle impostazioni e ruotando la *manopola* per cambiare il valore impostato.

POTENZA GRILL



Sono disponibili 3 livelli di potenza per il grill: 1 (basso), 2 (medio), 3 (alto). Il valore predefinito è visualizzato tra due simboli "--" lampeggianti.





Ruotare la *manopola* per selezionare la potenza del grill desiderata, quindi premere  per confermare.

DURATA



Quando l'icona  lampeggia sul display, utilizzare la *manopola* per impostare la durata desiderata, quindi premere  per confermare.

È possibile non impostare la durata per gestire manualmente la cottura: Premere  per confermare e avviare la funzione.

Nota: dopo l'avvio del forno, il tempo di cottura può essere modificato ruotando la *manopola*; ad ogni pressione di  il tempo di cottura aumenta di 30 secondi.

RISCALDAMENTO RAPIDO

Selezionare la funzione, quindi utilizzare la *manopola* per impostare la temperatura richiesta e premere  per confermare e avviare la funzione selezionata.



Un segnale acustico indicherà che il forno ha raggiunto la temperatura desiderata.

Nota: è consigliabile non sistemare il cibo nel forno prima che la funzione selezionata sia conclusa.

3. AVVIARE LA FUNZIONE

☑ Una volta che i valori corrispondono a quelli desiderati, premere per avviare la funzione.

Ogni pressione successiva del tasto ☑ aumenterà la durata di cottura di ulteriori 30 secondi.

Nota: Premendo ☑ è possibile interrompere in qualsiasi momento la funzione in corso.

. JET START

A forno spento, è possibile premere ☑ per avviare la cottura con la funzione microonde impostata alla potenza massima (900 W) per 30 secondi.

.BLOCCO DI SICUREZZA

Questa funzione si attiva automaticamente per prevenire un avvio involontario del forno.



Aprire e chiudere la porta, poi premere ☑ per avviare la funzione.

4. PAUSA

Per sospendere una funzione attiva, per esempio per mescolare o girare gli alimenti, è sufficiente aprire la porta.

Per riprendere, chiudere lo sportello e premere ☑.

PAUSA AUTOMATICA
(MESCOLARE O GIRARE GLI ALIMENTI)

Alcune funzioni prevedono una pausa per consentire di girare o mescolare gli alimenti.



Quando il forno interrompe la cottura, aprire la porta per eseguire le operazioni indicate prima di chiuderla nuovamente e premere ☑ per riprendere al cottura.

5. TEMPO DI FINE COTTURA

Un segnale acustico e il display avviseranno che la cottura è terminata.



Per prolungare la cottura mantenendo i valori impostati, ruotare la *manopola* per impostare un nuovo tempo di cottura e premere ☑.

. RAFFREDDAMENTO

Al termine di una funzione con aria calda, il forno può eseguire una procedura di raffreddamento. Sul display viene visualizzato "Raffreddamento attivato".

Alla fine del ciclo di raffreddamento, il forno si spegne automaticamente.

Nota: la procedura di raffreddamento può essere interrotta aprendo lo sportello e, all'occorrenza, può essere riattivata richiudendo lo sportello.

. BLOCCO DEI TASTI

Per bloccare i tasti, tenere premuto ☑ per almeno 5 secondi.



Per disattivare, ripetere la stessa procedura.

Nota: il blocco a chiave può essere attivato anche durante la cottura.

Per ragioni di sicurezza, è possibile spegnere il forno in ogni momento premendo a lungo ☑.

TABELLA DI COTTURA

CIBO	FUNZIONE	PRERISC.	TEMP. (°C)	POTENZA (W)	DURATA	ACCESSORI
Torte lievitate		-	160 - 180	-	30 - 60	
		-	160 - 180	90	25 - 50	
Torte ripiene (cheese cake, strudel, torta di mele)		Sì	160-190	-	35 - 70	
Biscotti		Sì	170-180	-	10 - 20	
Meringhe		Sì	100-120	-	40 - 50	
Panini		Sì	210-220	-	10 - 12	
Pagnotta		Sì	180-200	-	30 - 35	
Pizza / Focaccia		Sì	190-220	-	20 - 40	
Pizza (0,4-0,5 kg)		-	-	-	14 - 16	
Torte salate (torta di verdure, quiche lorraine)		Sì	180-190	-	40 - 55	
Quiche Lorraine (1-1,2 kg)		-	-	-	18 - 20	
Lasagne / Pasta al forno		-	-	350 - 500	15 - 40	
Arrosto di agnello / Vitello / Roastbeef (1,3-1,5 kg)		-	170-180	-	70 - 80*	
		-	160-180	160	50 - 70*	
Roastbeef - media cottura (1,3-1,5 kg)		-	170-180	-	40 - 60*	
Pollo arrosto / Coniglio / Anatra (intera 1-1,2 kg)		-	210-220	-	50 - 70*	
		-	210-220	350	45 - 60*	
Pollo / Coniglio / Anatra (filetti / pezzi 0,4-1 kg)		-	-	350 - 500	20 - 40*	
		-	-	-	12 - 18	
Pesce al forno (intero)		-	-	160 - 350	20 - 40	
Filetti / tranci di pesce		Sì	-	-	15 - 30*	
Verdure ripiene (pomodori, zucchine, melanzane...)		-	-	500 - 650	25 - 50	
Pane tostato		-	-	-	3 - 6	
Salsicce / Spiedini / Costine / Hamburger		-	-	-	20 - 40*	
Salsicce / hamburger (0,2-1 kg)		Sì**	-	-	6 - 16	
Patate al forno		-	-	350 - 500	20 - 40*	
Patate a spicchi (0,3-0,8 kg)		-	-	-	10 - 20	
Frutta cotta		-	-	160 - 350	15 - 25	
Verdure gratin		-	-	-	15 - 25	
Verdure fritte (0,3-0,8 kg)		Sì**	-	-	8 - 18	

* Girare gli alimenti a metà cottura.

** Preriscaldare il piatto crisp per 3-5 minuti.

FUNZIONI	Crisp 	Ventilato 	Ventilato + Micr. 	Grill 	Grill + Microonde
ACCESSORI	Piatto / contenitore adatto alle microonde e al calore 	Griglia 	Teglia rettangolare 	Piatto Crisp 	

PULIZIA

Assicurarsi che l'apparecchio si sia raffreddato prima di eseguire ogni operazione.

Non utilizzare pulitrici a getto di vapore.

Non usare pagliette metalliche, panni abrasivi e detersivi abrasivi o corrosivi che possano danneggiare le superfici.

SUPERFICI INTERNE ED ESTERNE

- Pulire le superfici con un panno in microfibra umido. Se molto sporche, aggiungere qualche goccia di detersivo neutro. Asciugare con un panno asciutto.
- Pulire i vetri della porta con detersivi liquidi specifici.
- A intervalli regolari o in caso di traboccamenti, togliere il piatto rotante e il suo supporto per pulire la base del forno, rimuovendo tutti i residui di cibo.
- Il grill non necessita di alcuna pulizia perché il calore intenso brucia direttamente lo sporco. attivare la funzione a intervalli regolari.

ACCESSORI

È possibile lavare in lavastoviglie tutti gli accessori ad eccezione del piatto Crisp. Il piatto Crisp deve essere pulito con acqua e un detersivo neutro. Per lo sporco più tenace, strofinare delicatamente con un panno. Far raffreddare il piatto Crisp prima di lavarlo.

RISOLUZIONE DEI PROBLEMI

Problema	Possibile causa	Soluzione
Il forno non funziona.	Interruzione di corrente elettrica. Disconnessione dalla rete principale.	Verificare che ci sia tensione in rete e che il forno sia collegato all'alimentazione elettrica. Spegner e riaccendere il forno e verificare se l'inconveniente persiste.
Il forno fa rumore anche se spento.	Ventola di raffreddamento attiva.	Aprire la porta o tenere premuto  .
Il display mostra la lettera "F" seguita da una lettera o un numero.	Guasto software.	Contattare il Servizio Assistenza di zona e comunicare la lettera o il numero che segue la lettera "F".

SCHEDA TECNICA

 [www](http://www.docs.whirlpool.eu) La scheda tecnica del prodotto con i dati energetici dell'apparecchio può essere scaricata dal sito Internet docs.whirlpool.eu

COME OTTENERE LE ISTRUZIONI PER L'USO

>  [www](http://www.docs.whirlpool.eu) Scaricare le Istruzioni per l'uso dal sito web docs.whirlpool.eu (è possibile utilizzare questo codice QR) specificando il codice prodotto.



> In alternativa, contattare il Servizio di Assistenza Clienti

CONTATTARE IL SERVIZIO ASSISTENZA CLIENTI

I contatti possono essere trovati sul manuale di garanzia. Prima di contattare il Servizio Assistenza, prepararsi a fornire i codici riportati sulla targhetta matricola del prodotto.

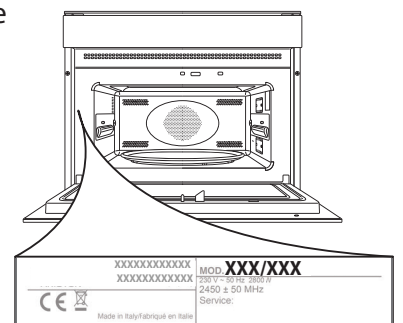

400011091756/B

Printed in Italy

DAGLIG REFERANSE -VEILEDNING



TAKK FOR AT DU HAR KJØPT ET WHIRLPOOL-PRODUKT

For å motta lettere forståelig hjelp og støtte, vennligst registrere produktet ditt på www.whirlpool.eu/register



Du kan laste ned sikkerhetsanvisninger og bruks- og vedlikeholdsveiledningen ved å besøke vår hjemmeside docs.whirlpool.eu og følge anvisningene bakerst i dette heftet.



Før du tar apparatet i bruk, må du lese helse- og sikkerhetsveiledningen nøye.

PRODUKTIVBESKRIVELSE

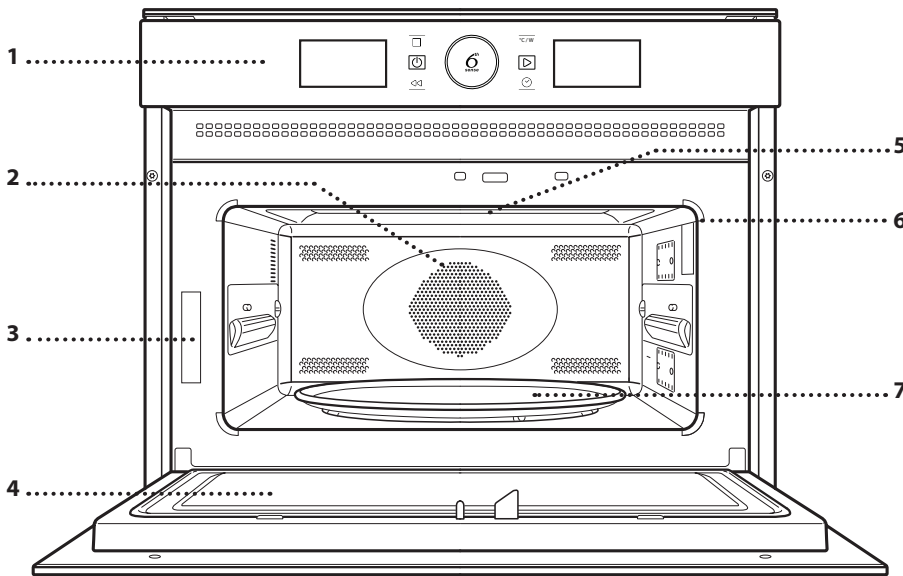

1. Kontrollpanel
2. Rundt varmeelement (ikke synlig)
3. Identifikasjonsskilt (må ikke fjernes)
4. Dør
5. Øvre varmeelement/grill
6. Lys
7. Roterende tallerken

BETJENINGSPANEL

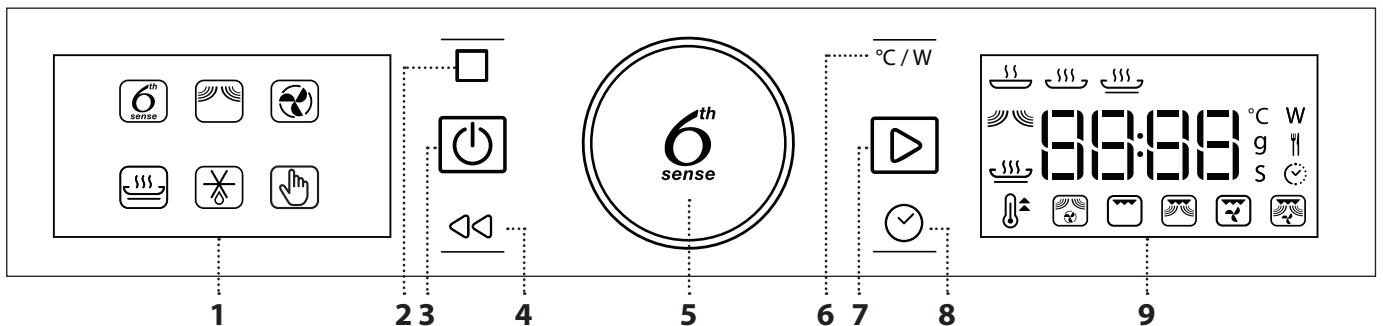

1. VENSTRE DISPLAY

2. PAUSE

For å ta en pause i stekesyklusen

3. PÅ/AV

For å slå ovnen av og på, og for å stoppe en aktiv funksjon til enhver tid.

4. TILBAKE

Får å gå tilbake til forrige meny.

5. ROTASJONSKNAPP/ 6th SENSE-KNAPP

Drei bryteren for å bla gjennom funksjonene og endre stekeinnstillingene. Trykk  for å velge, stille inn, få tilgang til, og bekrefte funksjoner og parametere og så starte stekeprogrammet.

6. EFFEKT

For å tilpasse grillnivå eller mikrobølgeeffekt.

7. START

For å starte funksjoner og bekrefte innstillingene

8. KLOKKE

For å stille inn klokken samt stille inn eller endre tilberedningstiden.

9. HØYRE DISPLAY

TILBEHØR

ROTARENDE TALLERKEN

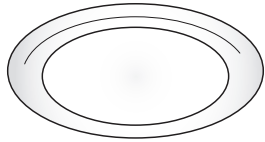

Når den er plassert på sin støtte, kan den roterende glasstallerkenen brukes med alle metodene for tilberedning. Den roterende tallerkenen skal alltid brukes som et

utgangspunkt for andre beholdere eller tilbehør, med unntak av det rektangulære stekebrettet.

STØTTE TIL DEN ROTARENDE TALLERKENEN

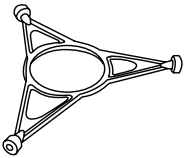

Bruk kun støtten til den roterende glasstallerkenen. Ikke plasser annet tilbehør på støtten.

CRISP-PANNE

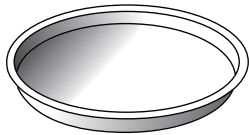

Må kun brukes med funksjonen som er angitt. Crisp-pannen må alltid være plassert midt på glassplatetallerken og kan forvarmes når den er tom, ved

hjelp av spesielle funksjon for dette formål. Plasser maten direkte på crisp-pannen.

HÅNDTAK FOR CRISP-PANNEN

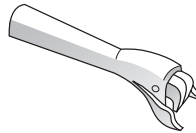

Nyttig for å fjerne den varme crisp-pannen fra ovnen.

RIST

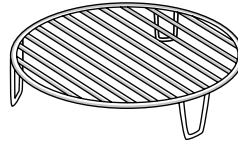

Dette gjør at du kan plassere maten nærmere grillen, for å oppnå en perfekt gyllen farge på maten din. Sett risten på den roterende tallerkenen, og påse at den ikke kommer i kontakt med

andre overflater.

REKTANGULÆRT BAKEBRETT

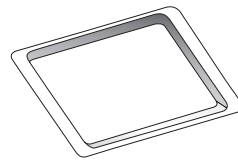

Bruk kun stekeplaten med funksjoner som gjør det mulig å tilberede maten i varmluftsovn; den må aldri brukes i kombinasjon med mikrobølger. Sett platen inn horisontalt, slik at

den hviler på risten i ovnsrommet.

Merk: Du trenger ikke å fjerne dreieskiven og støtten når du bruker den rektangulære stekeplaten.

Antall og type tilbehør kan variere avhengig av hvilken modell som du kjøpt. Annet tilbehør som ikke medfølger kan kjøpes separat gjennom kundeservice.

Det er en rekke tilbehør tilgjengelig på markedet. Før du kjøper tilbehør, påse at det er egnet for bruk i mikrobølgeovn og tåler ovnstemperaturer.

Metallbeholdere for mat eller drikke bør aldri brukes under tilberedning i mikrobølgeovn.

Pass alltid på at mat og tilbehør ikke kommer i kontakt med de innvendige veggene i ovnen.

Pass alltid på at den roterende skiven kan dreie fritt før du slår på ovnen. Pass på å ikke velte den roterende skiven mens du setter inn eller tar ut annet tilbehør.

FUNKSJONER



6th SENSE-FUNKSJONER

Med 6th Sense-funksjonen, er det tilstrekkelig å velge type og vekt eller mengde matvarer for å oppnå best mulig resultat. Ovnen vil automatisk beregne de optimale innstillingene og fortsette å endre de mens tilberedningen pågår.
Den totale tiden inkluderer ikke fasene for forvarming.



6th SENSE OPPVARMING

For å varme opp ferdiglaget mat som enten er frossen eller har romtemperatur. Ovnen beregner automatisk verdiene som er nødvendige for å oppnå de beste resultatene på kortest tid. Plasser maten på en ildfast tallerken eller fat som tåler mikrobølger.

KATEGORI	MAT	VEKT
1	TALLERKENRETT	250 - 500 g
2*	FROSSEN PORSJON	250 - 500 g
3*	FROSSEN LASAGNE	250 - 500 g
4	SUPPER	200 - 800 g
5	DRIKKE	1 - 5 dl



6th SENSE STEKEING

For rask tilberedning av matvarer med optimale resultat. Bruk en ildfast form egnet for bruk i mikrobølgeovner.

KATEGORI	MAT	VEKT
1	BAKTE POTETER (Snu når du blir varslet)	200 g - 1 kg
2	FRISKE GRØNNSAKER (Skjer opp i like store stykker og tilfør 2 til 4 spiseskjeer vann. Lokk)	200 - 800 g
3*	FROSNE GRØNNSAKER (Snu når du blir varslet. Lokk)	200 - 800 g
4	HERMETISKE GRØNNSAKER	200 - 600 g
5	POPKORN	100 g



6th SENSE CRISP

For raskt oppvarming og tilberedning av frossen mat, og for å gi de en gylden, sprø overflate. Bruk denne funksjonen kun med crisp-pannen som inngår. Snu maten når du blir minnet om det.

KATEGORI	MAT	VEKT
1*	POMME FRITES (fordel utover i ett enkelt lag og dryss på salt før steking)	200 - 600 g
2*	PIZZA, TYNN BUNN	200 - 500 g
3*	PIZZA, TYKK BUNN	300 - 800 g
4*	KYLLINGVINGER, KYLLINGSTYKKER (Ha på litt olje på platen)	200 - 600 g
5*	FISKEPINNER (Crisp-pannen må varmes på forhånd)	200 - 600 g

Nødvendig tilbehør: Crisp-panne, håndtak til crisp-pannen



MIKROBØLGER

For å tilberede raskt, og varme opp mat eller drikke.

EFFEKT	ANBEFALT FOR
900 W	Rask oppvarming av drikke eller andre matvarer med høyt vanninnhold
750 W	Tilberede grønnsaker
650 W	Tilberede kjøtt og fisk
500 W	Tilberedning av kjøttsauser eller sauser som inneholder ost eller egg. Etterbehandling av kjøttpaier eller pastaretter
350 W	Langsom, forsiktig matlaging. Perfekt for å smelte smør eller sjokolade
160 W	Tining av frosne matvarer eller mykgjøring av smør og ost
90 W	Mykgjøre iskrem



VARMLUFT

For å tilberede retter på en måte for der man oppnår samme resultat som ved anvendelse av en konvensjonell ovn. Stekeplaten eller andre kokekar som er egnet for bruk i ovn kan brukes til å tilberede visse matvarer.

Anbefalt tilbehør: Rektangulær stekeplate, rist



CRISP

For å brune en rett perfekt, både på den over- og undersiden av maten. Denne funksjonen må kun brukes med den spesielle crisp-pannen.

Nødvendig tilbehør: Crisp-panne, håndtak for crisp-pannen



JET DEFROST

For rask opptining av forskjellige typer matvarer ganske enkelt ved å spesifisere deres vekt. Mat bør plasseres direkte på den roterende glasstallerkenen. Snu maten når du blir minnet om det.

KATEGORI	MAT	VEKT
1*	KJØTT (kjøttdeig, koteletter, biff, kjøttstykker)	100 g - 2 kg
2*	FJÆRFE (hel kylling, stykker eller fileter)	100 g - 2,5 kg
3*	FISK (hel, steker eller fileter)	100 g - 2 kg
4*	GRØNNSAKER (blandede grønnsaker, erter, brokkoli osv.)	100 g - 2 kg
5*	BRØD (brødsiver, boller, rundstykker)	100 g - 1 kg



MANUELLE FUNKSJONER



HURTIG OPPVARMING

For raskt å varme opp ovnen før kokesyklusen. Vent til funksjonen er ferdig, før du legger mat i ovnen.



VARMLUFT + MIKROBØLGE

For å forberede ovnsretter i løpet av kort tid.

Nødvendig tilbehør: rist



GRILL

For bruning, grilling og gratenger. Vi anbefaler å snu maten under tilberedningen. For best resultat, forvarm grillen i 3-5 minutter.

Nødvendig tilbehør: rist



GRILL+MB

For å raskt tilberede og gratinere retter med en kombinasjon av mikrobølgeovnen og grillfunksjonen.

Nødvendig tilbehør: rist



TURBOGRILL

For perfekt resultat, kombiner grill- og varmluftfunksjonene. Vi anbefaler å snu maten under tilberedningen.

Nødvendig tilbehør: For raskt å tilberede og brune din mat, kombinere mikrobølgeovn, grill og varmluftsovnens funksjoner. rist



TURBO GRILL + MB

For raskt å tilberede og brune din mat, kombinere mikrobølgeovn, grill og varmluftsovnens funksjoner.

Nødvendig tilbehør: rist

FØRSTE GANGS BRUK

. INNSTILLING AV KLOKKEN

Du må stille inn klokken når du slår på ovnen for første gang.



De to sifrene for timen vil begynne å blinke: Vri på bryteren for å stille inn timen, og trykk deretter på for å bekrefte.





De to sifrene minuttene vil begynne å blinke. Vri på bryteren for å stille inn minuttene og trykk for å bekrefte.

Merk: For å endre på klokken ved et senere tidspunkt, trykk og hold i minst ett sekund mens ovnen er av, og gjenta trinnene ovenfor.

Du må kanskje stille inn klokken på nytt etter langvarige strømbrudd.

DAGLIG BRUK

1. VELG EN FUNKSJON

Når ovnen er av, vises kun klokken på displayet. Trykk og hold nede  for å slå på ovnen. Vri på *bryteren* for å se de viktigste funksjonene som er tilgjengelige på venstre display. Velg én og trykk .

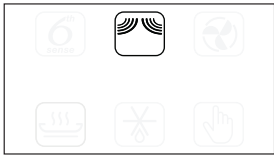

For å velge en underfunksjon (hvor denne er tilgjengelig), velg hovedfunksjonen og trykk deretter på  for å bekrefte og gå til menyen med funksjoner.

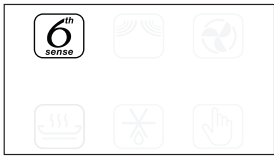

Vri på *bryteren* for å velge blant de tilgjengelige underfunksjonene på høyre display, og trykk deretter på  for å bekrefte.



2. STILL INN EN FUNKSJON

. AUTOMATISKE FUNKSJONER / JET DEFROST

MATKATEGORI

Når du har valgt én av de automatiske funksjonene, må du velge hvilken matvarekategori du tilbereder.





Når  ikonet blinker, vri på *bryteren* for å velge hvilken kategori du ønsker og trykk deretter på  for å bekrefte.

VEKT

For å oppnå best resultat, krever de automatiske funksjonene (og Jet Defrost/Hurtig tining) at du legger inn hvor mye maten veier, ved å velge blant standardinnstillingene: ovnen vil beregne den ideelle tiden for funksjonen som gjelder for hver matkategori.



Når standardinnstillingene vises på displayet og  ikonet blinker, vri på *bryteren* for å stille inn vekten og trykk deretter på  for å bekrefte.

. MANUELLE FUNKSJONER

Etter at du har valgt funksjonen du ønsker, kan du endre dens innstillinger. Displayet vil vise innstillingene som kan endres i sekvens.

MIKROBØLGEEFFEKT/ TEMPERATUR



Når **W** ikonet blinker på display, vri *bryteren* for å regulere innstilling av styrke, og trykk deretter  for å bekrefte og fortsett for å endre innstillingene som følger (hvis mulig).

Merk: Når funksjonen er aktivert, kan effekten endres ved å trykke  for å få tilgang til menyen med innstillinger, vri deretter på *bryteren* for å endre innstillingen.

GRILLEFFEKT

Det finnes definerte effektnivå for grilling: 1 (lav), 2 (mid), 3 (høy). Standardverdien vises mellom to blinkende "-" symboler.



Vri på *bryteren* for å stille ønsket grillnivå, og trykk deretter på  for å bekrefte.

VARIGHET

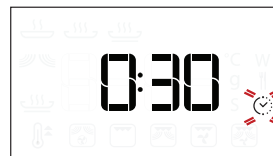

Når  ikonet blinker på display, bruk *bryteren* for å stille inn steketiden du ønsker og trykk deretter  for å bekrefte.

Du trenger ikke stille inn steketiden dersom du ønsker å styre steking manuelt: Trykk  for å bekrefte og starte funksjonen.

Merk: Du kan regulere steketiden, mens steking pågår, ved å vri på *bryteren*; hver gang du trykker på , øker du steketiden med 30 sekund.

HURTIG OPPVARMING

Velg funksjonen, og bruk deretter *bryteren* for å stille inn ønsket temperatur, og trykk  for å bekrefte og starte funksjonen.





Når ovnen når måltemperaturen, begynner en varsellyd å pipe.

Merk: Det er lurt å unngå å sette maten inn i ovnen før denne funksjonen er avsluttet.

3. AKTIVERE FUNKSJONEN

Når du har fastsatt alle innstillingene du trenger, trykk på  for å aktivere funksjonen.

Hver gang  knappen trykkes igjen, vil steketiden økes med ytterligere 30 sekunder.

Merk: Du kan trykke  når som helst for å stoppe funksjonen som for øyeblikket er aktiv.

. JET START

Når ovnen er slått av, kan du trykke på  for å aktivere matlaging med mikrobølge-funksjonen stilt inn på full effekt (900 W) i 30 sekunder.

. SIKKERHETSLÅS

Denne funksjonen aktiveres automatisk for å hindre at ovnen blir slått på utilsiktet.



Åpne og lukk døren, og trykk deretter på  for å starte funksjonen.

4. PAUSE

For å sette en aktiv funksjon på pause, for eksempel for å røre i eller snu maten, er det tilstrekkelig å åpne døren.

For å starte den opp igjen, lukk døren og trykk på .

AUTOMATISK PAUSE
(RØR ELLER SNU MATEN)

Visse funksjoner vil bli satt på pause for at du skal kunne snu eller røre i maten.



Når ovnen har satt steking på pause, må du åpne døren og utføre handlingen du blir minnet om å gjøre, før du lukker døren igjen og trykker  for å fortsette steking.

5. TILBEREDNINGENS SLUTTID

Du vil høre et akustisk signal og display indikerer at steking er avsluttet.



For å forlenge tilberedningstiden uten å endre innstillingene, vri på *bryteren* for å stille inn en ny tilberedningstid og trykk på .

. NEDKJØLING

Når en funksjon med varmluft er ferdig, kan ovnen utføre en avkjølingsfase.

Displayet viser da «Cool on».

Etter denne prosedyren vil ovnen slå seg av automatisk.

Merk: avkjølingsprosedyren kan avbrytes ved å åpne døren og den vil eventuelt aktiveres på nytt, dersom det er nødvendig, ved å lukke den igjen.

. TASTELÅS

For å låse tastaturet, trykk og hold inne  i minst 5 sekund.



Gjør dette på nytt for å låse opp tastaturet.

Merk: Tastlåsen kan også aktiveres mens steking pågår. Av sikkerhetsmessige grunner, kan ovnen slås av når som helst ved å trykke og holde nede .

TILBEREDNINGSTABELL

MAT	FUNKSJON	FORVARM	TEMP. (°C)	EFFEKT (W)	VARIGHET	TILBEHØR
Kaker med hevemidler/gjær		-	160 - 180	-	30 - 60	
		-	160 - 180	90	25 - 50	
Fylte terter (ostekake, strudel, eplepai)		Ja	160-190	-	35 - 70	
Kjeks		Ja	170-180	-	10 - 20	
Marengs		Ja	100-120	-	40 - 50	
Rundstykker		Ja	210-220	-	10 - 12	
Brød		Ja	180-200	-	30 - 35	
Pizza/Pai		Ja	190-220	-	20 - 40	
Pizza (0,4-0,5 kg)		-	-	-	14 - 16	
Middagspaier (grønnsakpai, quiche Lorraine)		Ja	180-190	-	40 - 55	
Quiche Lorraine (1-1,2 kg)		-	-	-	18 - 20	
Lasagne/bakt pasta		-	-	350 - 500	15 - 40	
Stekt lam/Kalv/Roastbeef (1,3-1,5 kg)		-	170-180	-	70 - 80*	
		-	160-180	160	50 - 70*	
Roast beef – medium (1,3-1,5 kg)		-	170-180	-	40 - 60*	
Stekt Kylling/Kanin/And (hel 1-1,2 kg)		-	210-220	-	50 - 70*	
		-	210-220	350	45 - 60*	
Kylling/kanin/and (fileter/biter 0,4-1 Kg)		-	-	350 - 500	20 - 40*	
		-	-	-	12 - 18	
Bakt fisk (hel)		-	-	160 - 350	20 - 40	
Fiskefilet/skiver		Ja	-	-	15 - 30*	
Fylte grønnsaker (tomater, squash, auberginer...)		-	-	500 - 650	25 - 50	
Ristet brød		-	-	-	3 - 6	
Pølser / grillspyd / spareribs / hamburgere		-	-	-	20 - 40*	
Pølser/hamburgere (0,2-1 kg)		Ja**	-	-	6 - 16	
Bakte poteter		-	-	350 - 500	20 - 40*	
Potetbåter (0,3-0,8 kg)		-	-	-	10 - 20	
Bakt frukt		-	-	160 - 350	15 - 25	
Gratinerte grønnsaker		-	-	-	15 - 25	
Stekte grønnsaker (0,3-0,8 kg)		Ja**	-	-	8 - 18	

* Snu maten halvveis gjennom steking.

** Forvarm crisp-pannen i 3-5 minutter.

FUNKSJONER	Crisp 	Varmluft 	Varmluft + MB 	Grill 	Grill + MB
TILBEHØR	Varmebestandig plate/beholder egnet for bruk i mikrobølgeovner 	Rist 	Rektangulært bakebrett 	Crisp-panne 	

RENGJØRING

Pass på at apparatet er avkjølt før du utfører vedlikehold eller rengjøring.

Ikke bruk damprengjøringsutstyr.

Ikke bruk stålull, skuresvamper eller slipende/etsende rengjøringsmidler, da disse kan skade apparatets overflate.

INDRE OG YTRE OVERFLATER

- Rengjør overflatene med en fuktig mikrofiberklut. Hvis de er svært tilsmussede, tilsettes noen dråper nøytralt rengjøringsmiddel. Tørk med en tørr klut.
- Rengjør dørglasset med et egnet flytende vaskemiddel.
- Med jevne mellomrom, og i tilfelle av søl, fjern platespiller og støtten for å rengjøre bunnen av ovnen, fjern alle matrester.
- Grillen trenger ikke rengjøring, fordi den intense varmen brenner bort smusset. Bruk denne funksjonen med jevne mellomrom.

TILBEHØR

Alt tilbehør kan vaskes i oppvaskmaskin med unntak av crisp-pannen. Crisp-pannen bør rengjøres med vann og et mildt rengjøringsmiddel. For fastsittende skitt, gni forsiktig med en klut. La alltid crisp-pannen kjøle seg ned før rengjøring.

PROBLEMLØSNING

Problem	Mulig årsak	Løsning
Ovnen fungerer ikke.	Strømbrydd. Den er koplet fra nettet.	Kontroller at det ikke er strømbrydd og påse at ovnen er tilkoblet strømmettet. Slå av og på ovnen og se om problemet har løst seg.
Ovnen gir fra seg lyder, selv når den er slått av.	Kjøleviften er i drift.	Åpne døren eller hold inne  .
Displayet viser bokstaven "F" etterfulgt av en bokstav eller et nummer.	Programvarefeil.	Ta kontakt med nærmeste Ettersalgsservicesenter og oppgi bokstaven eller nummeret som følger bokstaven "F".

PRODUKTKORT

 Produktkortet med informasjon om energiforhold for apparatet kan lastes ned fra vår hjemmeside docs.whirlpool.eu

SLIK SKAFFER DU DEG BRUKS- OG VEDLIKEHOLDSVEILEDNINGEN

>  Last ned bruks- og vedlikeholdsveiledningen fra vår hjemmeside docs.whirlpool.eu (du kan bruke denne QR-koden), for å spesifisere produktets kommersielle kode.



> Eller du kan ta kontakt med vår kundeservice

HENVEND DEG TIL KUNDESERVICE

Du vil finne informasjon om hvordan du kan kontakte oss i garantiheftet. Når du kontakter vår kundeservice for tjenester etter salg, vennligst opplys kodene som er oppgitt på produktets typeskilt.

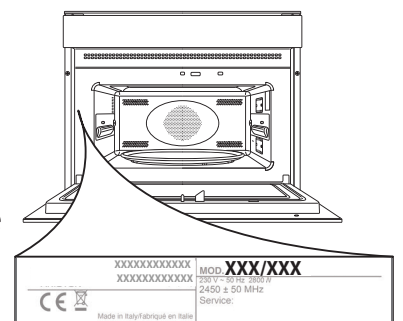

400011091756/B

Printed in Italy

GUIA DE CONSULTA DIÁRIA



OBRIGADO POR ADQUIRIR UM PRODUTO WHIRLPOOL

Para receber mais informações e assistência, registre o seu produto em www.whirlpool.eu/register



Pode transferir as Instruções de Segurança e o Guia de Utilização e Manutenção visitando o nosso website docs.whirlpool.eu e seguindo as instruções no verso do presente guia.



Antes de utilizar o aparelho, leia atentamente o guia de Saúde e Segurança.

DESCRIÇÃO DO PRODUTO

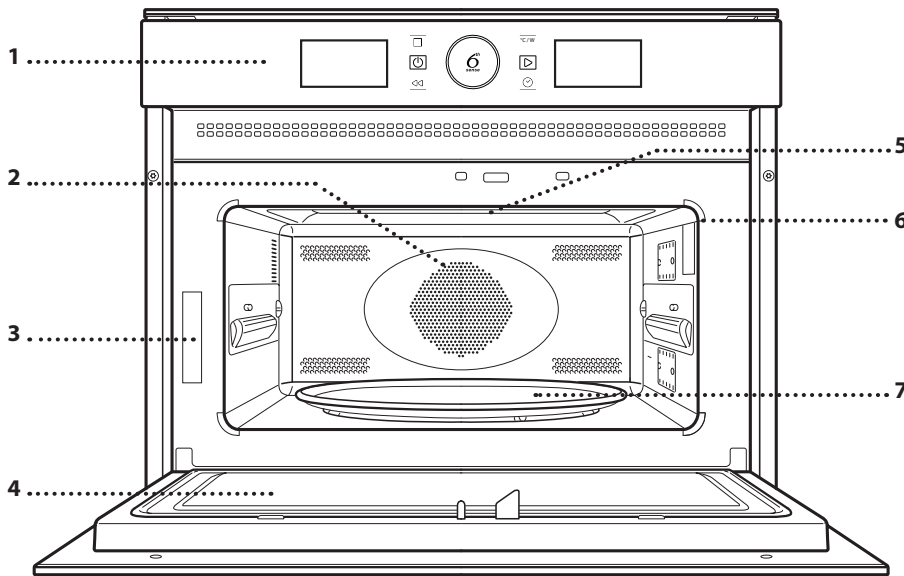

1. Painel de controlo
2. Resistência circular (invisível)
3. Placa de identificação (não remover)
4. Porta
5. Resistência superior/grelhador
6. Luz
7. Prato rotativo

PAINEL DE COMANDOS

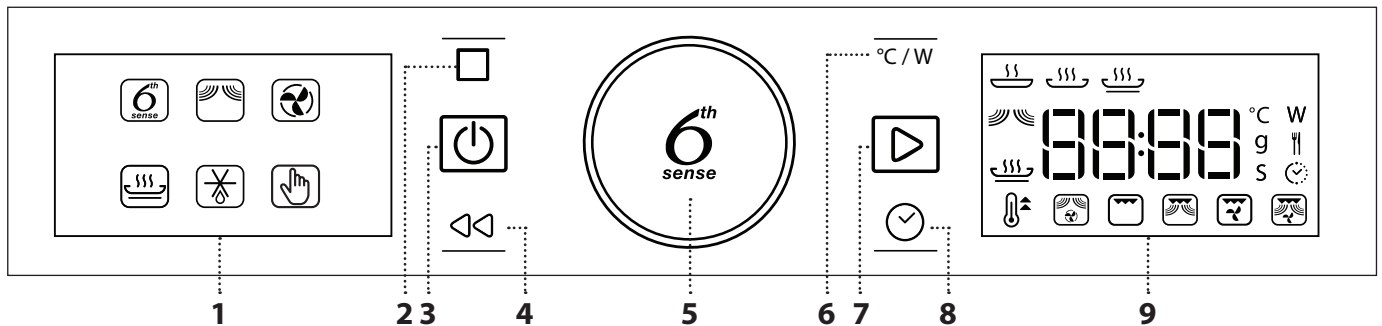

1. VISOR ESQUERDO

2. PAUSA

Para interromper um ciclo de cozedura

3. LIGAR/DESLIGAR

Para ligar e desligar o forno e parar uma função ativa a qualquer momento.

4. RETROCEDER

Para regressar ao ecrã anterior.

5. BOTÃO ROTATIVO/BOTÃO 6th SENSE

Rode-o para navegar pelas funções e ajustar todos os parâmetros de cozedura. Prima  para selecionar, definir, aceder ou confirmar funções ou parâmetros e, eventualmente, para iniciar o programa de cozedura.

6. POTÊNCIA

Para ajustar a temperatura, a potência do grelhador ou do micro-ondas.

7. INICIAR

Para iniciar funções e confirmar definições

8. TEMPO

Para definir a hora, bem como definir ou ajustar o tempo de cozedura.

9. VISOR DIREITO

ACESSÓRIOS

PRATO ROTATIVO

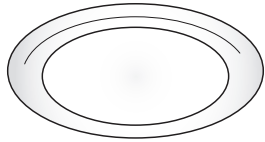

Colocado no respetivo suporte, o prato rotativo de vidro pode ser utilizado com todos os métodos de cozedura.

O prato rotativo tem sempre de ser utilizado como base

para outros recipientes ou acessórios, à exceção do tabuleiro de assar retangular.

SUPORTE DO PRATO ROTATIVO

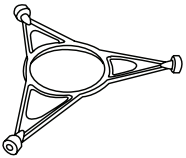

Utilize apenas o suporte para o prato rotativo de vidro. Não apoie outros acessórios no suporte.

PRATO CRISP

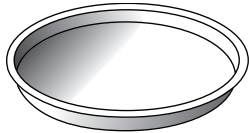

Apenas para utilização com a função designada.

O prato Crisp tem sempre de ser posicionado no centro do prato rotativo de vidro e pode ser pré-aquecido quando estiver vazio,

utilizando a função especial exclusiva para este efeito. Coloque os alimentos diretamente no prato Crisp.

MANÍPULO PARA O PRATO CRISP

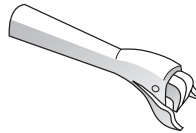

Útil para retirar o prato Crisp quente do forno.

CESTO DE ARAME

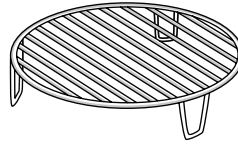

Permite colocar os alimentos mais próximos do grelhador para obter um prato perfeitamente dourado. Coloque o cesto de arame sobre o prato rotativo, certificando-se de que esta não

entra em contacto com outras superfícies.

TABULEIRO DE ASSAR RETANGULAR

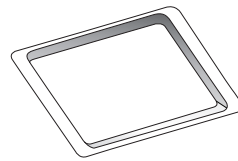

Utilize o tabuleiro de assar apenas com funções que permitam a cozedura de convexão; nunca o utilize em combinação com o micro-ondas.

Introduza o tabuleiro na horizontal, apoiando-o no suporte do compartimento de cozedura.

Lembre-se: Não é necessário retirar o prato rotativo e o respetivo suporte quando utilizar o tabuleiro de assar retangular.

O número e o tipo de acessórios pode variar de acordo com o modelo adquirido. Pode adquirir separadamente no Serviço de Assistência Técnica quaisquer outros acessórios que não venham fornecidos.

Existem vários acessórios disponíveis no mercado. Antes de os comprar, certifique-se de que estes são adequados para serem utilizados no micro-ondas e que são resistentes às temperaturas do forno.

Os recipientes metálicos para alimentos ou bebidas nunca devem ser utilizados na função de micro-ondas.

Certifique-se sempre de que os alimentos e os acessórios não entram em contacto com as paredes interiores do forno.

Antes de ligar o forno certifique-se sempre de que o prato rotativo consegue rodar livremente. Tenha cuidado para não retirar o prato rotativo da posição correta ao introduzir ou retirar outros acessórios.

FUNÇÕES



FUNÇÕES 6th SENSE

Com as funções 6th Sense, basta selecionar o tipo e o peso ou a quantidade de alimentos para obter os melhores resultados possíveis. O forno irá calcular automaticamente as definições ideais e continuar a alterá-las à medida que a cozedura progride. O tempo total não inclui as fases de preparação ou de pré-aquecimento.

AQUECIMENTO 6th SENSE

Para aquecer refeições prontas congeladas ou à temperatura ambiente. O forno calcula automaticamente os valores necessários para obter os melhores resultados no menor tempo possível. Coloque os alimentos numa travessa ou num prato resistente ao calor adequado para fornos micro-ondas.

CATEGORIA	ALIMENTO	PESO
	PRATO RASO	250 - 500 g
	PORÇÃO CONGELADA	250 - 500 g
	LASANHA CONGELADA	250 - 500 g
	SOPAS	200 - 800 g
	BEBIDAS	1 - 5 dl

COZEDURA 6th SENSE

Para cozinhar alimentos rapidamente e obter os melhores resultados. Utilize um prato resistente ao calor/recipiente adequado para utilização no micro-ondas.

CATEGORIA	ALIMENTO	PESO
	BATATAS ASSADAS (Vire quando tal lhe for solicitado)	200 g - 1 kg
	LEGUMES FRESCOS (Corte em pedaços de tamanhos iguais e adicione 2 a 4 colheres de sopa de água. Tape.)	200 - 800 g
	LEGUMES CONGELADOS (Vire quando tal lhe for solicitado. Tape.)	200 - 800 g
	LEGUMES ENLATADOS	200 - 600 g
	PIPOCAS	100 g

CRISP 6th SENSE

Para aquecer rapidamente e cozinhar alimentos congelados, obtendo um tom dourado e uma cobertura estaladiça. Utilize apenas esta função com o prato Crisp fornecido. Vire os alimentos quando lhe for solicitado.

CATEGORIA	ALIMENTO	PESO
	BATATAS FRITAS (disponha as batatas numa única camada e salpique-as com sal antes de iniciar a cozedura)	200 - 600 g
	PIZZA, MASSA FINA	200 - 500 g
	PIZZA, MASSA NORMAL	300 - 800 g
	ASAS DE FRANGO, PEDAÇOS DE FRANGO (Unte ligeiramente o prato)	200 - 600 g
	DOURADINHOS (O prato Crisp deverá ser pré-aquecido)	200 - 600 g

Acessórios necessários: Prato Crisp, manípulo para o prato Crisp

MICRO-ONDAS

Para cozinhar rapidamente e aquecer alimentos ou bebidas.

POTÊNCIA	RECOMENDADA PARA
900 W	Aquecimento rápido de bebidas ou outros alimentos com elevado teor de água
750 W	Cozinhar legumes
650 W	Cozinhar carne e peixe
500 W	Cozinhar molhos para carne ou molhos que contenham queijo ou ovos. Terminar empadas ou gratinados de massa
350 W	Cozedura lenta. Perfeito para derreter manteiga ou chocolate
160 W	Descongelar alimentos congelados ou amolecer manteiga e queijo
90 W	Amolecer gelados

AR FORÇADO

Para cozinhar refeições de forma a obter resultados semelhantes ao de um forno convencional. O tabuleiro de assar ou outro recipiente para forno podem ser utilizados para cozinhar determinados alimentos.

Acessórios recomendados: Tabuleiro de assar retangular/grelha



CRISP

Para dar um tom dourado perfeito a um prato, tanto na parte superior como na parte inferior dos alimentos. Esta função só pode ser utilizada com o prato especial Crisp.

Acessórios necessários: Prato Crisp, manípulo para o prato Crisp



JET DEFROST

Para a descongelação rápida de diferentes tipos de alimentos, bastando para tal especificar o seu peso. Os alimentos devem ser colocados diretamente no prato rotativo de vidro. Vire os alimentos quando lhe for solicitado.

CATEGORIA	ALIMENTO	PESO
1*	CARNE (carne picada, costeletas, bifés, peças de carne recheadas)	100 g - 2 kg
2*	AVES (frango inteiro, em pedaços ou em filetes)	100 g - 2,5 kg
3*	PEIXE (postas inteiras ou filetes)	100 g - 2 kg
4*	VEGETAIS (legumes variados, ervilhas, brócolos, etc.)	100 g - 2 kg
5*	PÃO (pães, bolos)	100 g - 1 kg



FUNÇÕES MANUAIS



AQUECIMENTO RÁPIDO

Para aquecer rapidamente o forno antes de um ciclo de cozedura. Aguarde que a função termine antes de colocar alimentos no interior do forno.



AR FORÇADO + MO

Para preparar pratos de forno num curto período de tempo.

Acessórios necessários: cesto de arame



GRELHADOR

Para dourar, grelhar e gratinar. Recomendamos que vire os alimentos durante a cozedura. Para obter os melhores resultados, pré-aqueça o grelhador durante 3-5 minutos.

Acessórios necessários: cesto de arame



GRELHADOR + MO

Para cozinhar rapidamente e para gratinar pratos, combinando as funções de micro-ondas e de grelhador.

Acessórios necessários: cesto de arame



TURBO GRILL

Para obter resultados perfeitos, combinando as funções de grelhador e de convecção do forno. Recomendamos que vire os alimentos durante a cozedura.

Acessórios necessários: cesto de arame



TURBO GRILL + MO

Para cozinhar rapidamente e dourar pratos, combinando as funções de micro-ondas, grelhador e forno de convecção.

Acessórios necessários: cesto de arame

UTILIZAR PELA PRIMEIRA VEZ

. ACERTAR A HORA

Ao ligar o forno pela primeira vez, terá de definir a hora.



Os dois dígitos da hora começam a piscar: Rode o *botão seletor* para definir a hora e prima  para confirmar.





Os dois dígitos dos minutos começam a piscar. Rode o *botão seletor* para definir os minutos e prima  para confirmar.

Lembre-se: Para alterar a hora posteriormente, prima e mantenha premido  durante, pelo menos, um segundo com o forno desligado e repita os passos acima.

Poderá ter de acertar novamente a hora após um longo corte de energia.

UTILIZAÇÃO DIÁRIA

1. SELECIONAR UMA FUNÇÃO

Quando o forno está desligado, só aparece a hora no visor. Prima e mantenha premido  para ligar o forno. Rode o *botão seletor* para visualizar as funções principais disponíveis no visor esquerdo. Selecione uma e prima .

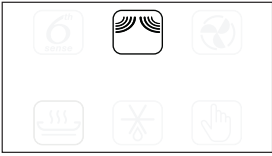

Para selecionar uma subfunção (se disponível), selecione a função principal e, em seguida, prima  para confirmar e aceder ao menu de funções.



Rode o *botão seletor* para selecionar a função pretendida de entre as subfunções no visor à direita e, em seguida, prima  para confirmar.



2. DEFINIR UMA FUNÇÃO

. FUNÇÕES AUTOMÁTICAS / JET DEFROST

CATEGORIA DOS ALIMENTOS

Uma vez seleciona uma função automática é necessário selecionar a categoria dos alimentos que irá cozinhar.





Quando o ícone  piscar, rode o *botão seletor* para selecionar a categoria pretendida e prima  para confirmar.

PESO

Para obter os melhores resultados, as funções automáticas (e a função Jet Defrost) requerem que introduza o peso dos alimentos selecionando de entre as predefinições: o forno calcula a duração de cozedura ideal para cada categoria de alimentos.



Quando as predefinições surgirem no visor e o ícone  piscar, rode o *botão seletor* para definir o peso e, em seguida, prima  para confirmar.

. FUNÇÕES MANUAIS

Após selecionar uma função, é possível alterar as suas definições.

O visor irá apresentar as definições que podem ser alteradas em sequência.

NÍVEL DE POTÊNCIA/TEMPERATURA DO MICRO-ONDAS



Quando o ícone **W** começar a piscar no visor, rode o *botão seletor* para ajustar as definições da potência e, de seguida, prima  para confirmar a sua seleção e continuar a alterar as definições seguintes (se possível).

Lembre-se: Uma vez ativada a função, a potência pode ser alterada premindo  para aceder ao menu das definições e, em seguida, rodando o *botão seletor* para alterar a definição.

POT GRELHADOR



Existem três níveis de potência definidos para grelhar: 1 (baixo), 2 (médio), 3 (alto). O valor predefinido é exibido entre dois "-" símbolos intermitentes.





Rode o botão para selecionar a temperatura pretendida e, em seguida, prima  para confirmar.

DURAÇÃO



Quando o  ícone pisca no visor, utilize o *botão seletor* para definir o tempo de cozedura pretendido e, em seguida, prima  para confirmar.

Não precisa de definir o tempo de cozedura, caso pretenda gerir a cozedura manualmente: Prima  para confirmar e iniciar a função.

Nota: Durante a cozedura é possível regular o tempo de cozedura rodando o *botão seletor*; cada vez que premir o botão , o tempo de cozedura aumenta em 30 segundos.

AQUECIMENTO RÁPIDO

Selecione a função e, em seguida, utilize o *botão seletor* para definir a temperatura pretendida; prima  para confirmar e iniciar a função.



Quando o forno atingir a temperatura pretendida, soa um alarme sonoro.

Lembre-se: recomendamos que não coloque os alimentos no forno antes do final desta função.

3. ATIVAR UMA FUNÇÃO

Após aplicar todas as definições pretendidas, prima  para ativar a função.

Sempre que premir novamente o botão , o tempo de cozedura aumenta mais 30 segundos.

Lembre-se: Poderá premir  em qualquer altura para interromper a função que estiver ativada nessa altura.

. JET START

Quando o forno estiver desligado, pode premir  para ativar a cozedura com a função de micro-ondas na potência máxima (900 W) durante 30 segundos.

. BLOQUEIO DE SEGURANÇA

Esta função é ativada automaticamente para evitar que o forno seja ligado inadvertidamente.



Abra e feche a porta e, em seguida, prima  para iniciar a função.

4. PAUSA

Para colocar em pausa uma função ativa, por exemplo, para poder mexer os alimentos ou virá-los, basta abrir a porta.

Para continuar, feche a porta e prima .

PAUSA AUTOMÁTICA

(MEXA OU VIRE OS ALIMENTOS)

Algumas funções são interrompidas automaticamente para permitir que mexa ou vire os alimentos durante a cozedura.



Interrompida a cozedura, abra a porta do forno e realize as ações que lhe forem solicitadas antes de fechar a porta novamente e premir  para continuar a cozedura.

5. TEMPO DE FIM DA COZEDURA

Será emitido um sinal sonoro e o visor indicará que a cozedura está concluída.



Para aumentar o tempo de cozedura sem alterar as definições, rode o *botão seletor* para definir um novo tempo de cozedura e prima .

. ARREFECIMENTO

Sempre que uma função que utiliza ar quente é concluída, o aparelho inicia um processo de arrefecimento.

A mensagem "Cool On" (A arrefecer) é apresentada no visor.

Após este procedimento o forno desliga-se automaticamente.

Lembre-se: o procedimento de arrefecimento pode ser interrompido abrindo a porta e será, eventualmente, reativado, se necessário, fechando-a novamente.

. PROTEÇÃO

Para bloquear o teclado, prima e mantenha premido  durante, pelo menos, 5 segundos.



Para desbloquear, repita o procedimento.

Lembre-se: a proteção pode também ser ativada durante a cozedura.























































































Por motivos de segurança, o forno pode ser desligado a qualquer momento, premindo continuamente .

TABELA DE COZEDURA

ALIMENTO	FUNÇÃO	PRÉ AQUECIM	TEMP. (°C)	POTÊNCIA (W)	DURAÇÃO	ACESSÓRIOS
Bolos com levedura		-	160 - 180	-	30 - 60	 
		-	160 - 180	90	25 - 50	 
Tartes recheadas (cheesecake, strudel, tarte de maçã)		Sim	160-190	-	35 - 70	 
Biscoitos		Sim	170-180	-	10 - 20	
Merengues		Sim	100-120	-	40 - 50	
Pãezinhos		Sim	210-220	-	10 - 12	
Pão de forma		Sim	180-200	-	30 - 35	
Pizza / Tarte		Sim	190-220	-	20 - 40	
Pizza (0,4 - 0,5 kg)		-	-	-	14 - 16	
Tartes salgadas (tarte de legumes, quiche Lorraine)		Sim	180-190	-	40 - 55	 
Quiche Lorraine (1 - 1,2 kg)		-	-	-	18 - 20	
Lasanha/massa gratinada		-	-	350 - 500	15 - 40	 
Borrego ou vitela assada/Carne de vaca assada (1,3-1,5 kg)		-	170-180	-	70 - 80*	 
		-	160-180	160	50 - 70*	 
Carne de vaca assada, média (1,3-1,5 kg)		-	170-180	-	40 - 60*	 
Frango/coelho/pato assado (inteiro 1 - 1,2 kg)		-	210-220	-	50 - 70*	 
		-	210-220	350	45 - 60*	 
Frango/Coelho/Pato (filetes/pedaços de 0,4-1 kg)		-	-	350 - 500	20 - 40*	 
		-	-	-	12 - 18	
Peixe assado (inteiro)		-	-	160 - 350	20 - 40	 
Filetes/postas de peixe		Sim	-	-	15 - 30*	 
Legumes recheados (tomates, curgetes, beringelas, etc.)		-	-	500 - 650	25 - 50	 
Pão tostado		-	-	-	3 - 6	
Salsichas/Espetadas/Costeletas/Hambúrgueres		-	-	-	20 - 40*	
Salsichas/hambúrgueres (0,2 - 1 kg)		Sim**	-	-	6 - 16	
Batatas assadas		-	-	350 - 500	20 - 40*	
Batatas fatiadas (0,3 - 0,8 kg)		-	-	-	10 - 20	
Fruta assada		-	-	160 - 350	15 - 25	 
Gratinado de legumes		-	-	-	15 - 25	 
Legumes fritos (0,3-0,8 kg)		Sim**	-	-	8 - 18	

* Vire o alimento a meio da cozedura.

** Pré-aqueça o prato Crisp durante 3-5 minutos.

FUNÇÕES	Crisp 	Ar forçado 	Ar forçado + MO 	Grelhador 	Grelhador + MO 
ACESSÓRIOS	Prato resistente ao calor/ recipiente adequado para utilização no micro-ondas 	Cesto de arame 	Tabuleiro de assar retangular 	Prato Crisp 	

LIMPEZA

Assegure-se de que o aparelho arrefece antes de executar qualquer operação de manutenção ou limpeza.

Não utilize aparelhos de limpeza a vapor.

Não utilize palha de aço, esfregões abrasivos ou produtos de limpeza abrasivos/corrosivos, uma vez que estes podem danificar as superfícies do aparelho.

SUPERFÍCIES INTERIOR E EXTERIOR

- Limpe as superfícies com um pano de microfibra húmido. Se estiverem muito sujas, acrescente alguns pingos de detergente com PH neutro. Termine a limpeza com um pano seco.
- Limpe o vidro da porta com um detergente líquido adequado.
- Periodicamente, ou quando houver derrames, retire o prato rotativo e o respetivo suporte para limpar o fundo do forno, retirando todos os restos de alimentos.
- O grelhador não precisa de ser limpo, uma vez que o calor intenso queima qualquer sujidade. Utilize esta função regularmente.

ACESSÓRIOS

Todos os acessórios podem ser lavados na máquina de lavar louça, exceto o prato Crisp. O prato Crisp deve ser lavado com água e um detergente suave. Para sujidade difícil, esfregue suavemente com um pano. Deixe sempre que o prato Crisp arrefeça antes de o limpar.

RESOLUÇÃO DE PROBLEMAS

Problema	Causa possível	Solução
O forno não está a funcionar.	Corte de energia. Desconexão da rede elétrica.	Verifique se existe energia elétrica proveniente da rede e se o forno está ligado à tomada elétrica. Desligue e volte a ligar o forno, para verificar se o problema ficou resolvido.
O forno emite ruídos, mesmo quando está desligado.	O ventilador de refrigeração está ativado.	Abra a porta ou prima  .
O visor apresenta a letra "F", seguida de um número ou de uma letra.	Falha de software.	Contacte o Serviço Pós-Venda mais próximo e indique a letra ou o número que acompanha a letra "F".

FICHA DE PRODUTO

 [www](http://www.docs.whirlpool.eu) A ficha do produto, incluindo os dados energéticos para este aparelho, pode ser transferida a partir do website **docs.whirlpool.eu**

COMO OBTER O GUIA DE UTILIZAÇÃO E MANUTENÇÃO

>  [www](http://www.docs.whirlpool.eu) Transfira o Guia de Utilização e Manutenção a partir do nosso website **docs.whirlpool.eu** (pode utilizar este código QR), especificando o código comercial do produto.



Em alternativa, contacte o nosso Serviço Pós-Venda

CONTACTAR O NOSSO SERVIÇO PÓS-VENDA

Pode encontrar os nossos contactos no manual de garantia. Ao contactar o nosso Serviço Pós-Venda, indique os códigos fornecidos na placa de identificação do seu produto.

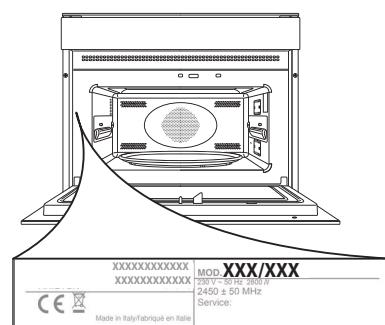

400011091756/B

Printed in Italy

GUÍA DE CONSULTA DIARIA



GRACIAS POR COMPRAR UN PRODUCTO WHIRLPOOL

Si desea recibir asistencia y soporte adicionales, registre su producto en www.whirlpool.eu/register



Puede descargarse las Instrucciones de seguridad y la Guía de uso y cuidado en nuestra página web docs.whirlpool.eu y siguiendo las instrucciones del dorso de este documento.



Antes de usar el aparato, lea atentamente las instrucciones de seguridad.

DESCRIPCIÓN DEL PRODUCTO

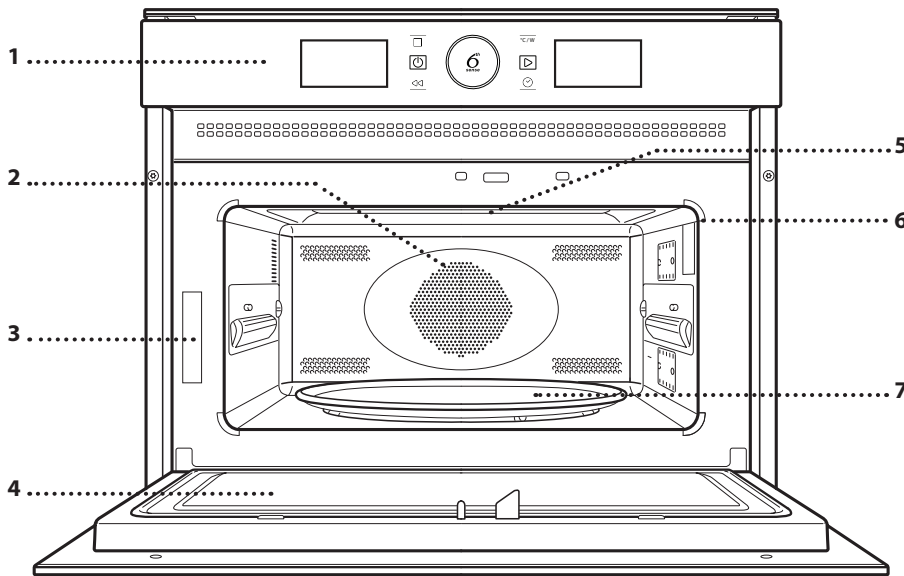

1. Panel de control
2. Resistencia circular (no visible)
3. Placa de características (no debe retirarse)
4. Puerta
5. Resistencia superior/grill
6. Ligera
7. Plato giratorio

PANEL DE CONTROL

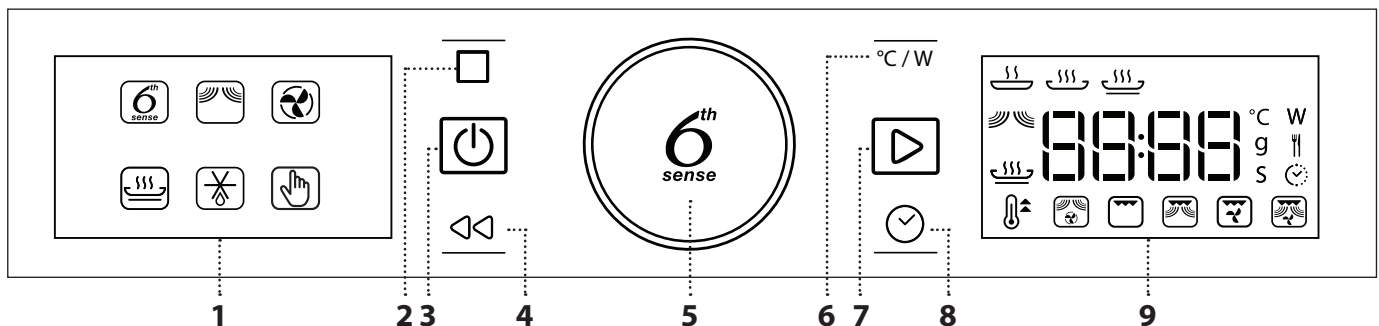

1. PANTALLA DE LA IZQUIERDA

2. PAUSA

Para detener un ciclo de cocción

3. ENCENDIDO/APAGADO

Para encender o apagar el horno y para detener una función activa en cualquier momento.

4. ATRÁS

Sirve para volver a la pantalla anterior.

5. SELECTOR ROTATIVO / BOTÓN 6th SENSE

Gírelo para desplazarse por las funciones y ajustar todos los parámetros de cocción. Pulse  para seleccionar, programar, acceder o confirmar las funciones o parámetros, y, eventualmente, para iniciar el programa de cocción.

6. POTENCIA

Para programar la temperatura, la potencia del grill o la del microondas.

7. INICIO

Para iniciar funciones y confirmar los ajustes

8. TIEMPO

Para configurar la hora y ajustar o modificar el tiempo de cocción.

9. PANTALLA DE LA DERECHA

ACCESORIOS

PLATO GIRATORIO

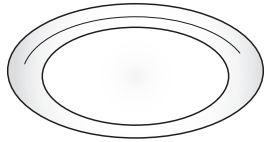

El plato giratorio debe estar colocado en su soporte y puede utilizarse en todos los métodos de cocción.

El plato giratorio se tiene que usar siempre como base para

otros recipientes o accesorios, a excepción de la bandeja pastelera rectangular.

SOPORTE DEL PLATO GIRATORIO

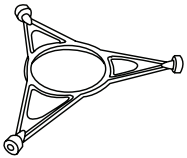

Utilice el soporte solamente para el plato giratorio de cristal. No coloque otros accesorios en el soporte.

PLATO CRISP

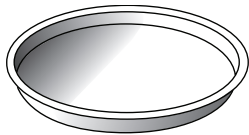

Utilizar solo con la función indicada.

La bandeja Crisp debe colocarse siempre en el centro del plato giratorio y puede precalentarse vacía utilizando la función

especial para ello. Coloque la comida directamente en la bandeja Crisp.

ASA DE LA BANDEJA CRISP

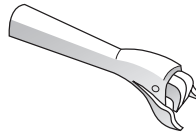

Muy práctica para sacar la bandeja Crisp caliente del horno.

PARRILLA

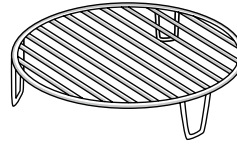

Con ella podrá colocar los alimentos más cerca del grill para obtener un dorado perfecto. Coloque la parrilla en el plato giratorio, asegurándose de que no entre en contacto con otras

superficies.

BANDEJA PASTELERA RECTANGULAR

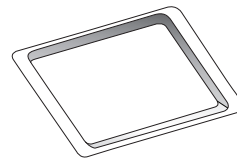

Utilice el plato para hornear rectangular exclusivamente con las funciones que permiten la cocción por convección; No debe utilizarla nunca en combinación con el microondas.

Introduzca el plato horizontalmente, apoyándolo en la rejilla del compartimento de cocción.

Nota: No es necesario que quite el plato giratorio ni su soporte cuando utilice el plato para hornear.

El número de accesorios puede variar de un modelo a otro. Los accesorios no incluidos pueden adquirirse aparte en el Servicio Postventa.

Hay varios accesorios disponibles en el mercado. Antes de adquirirlos, asegúrese de que son aptos para el microondas y resistentes a las temperaturas del horno.

Los contenedores metálicos para alimentos o bebidas no deben utilizarse nunca para la cocción con el microondas.

Asegúrese siempre de que ni los alimentos ni los accesorios entren en contacto con las paredes internas del horno.

Compruebe siempre que el plato giratorio gira sin problemas antes de poner en marcha el horno. Tenga cuidado de no desenganchar el plato giratorio cuando introduzca o saque otros accesorios.

FUNCIONES



FUNCIONES 6th SENSE

Con las funciones 6th Sense, simplemente seleccione el tipo y el peso o la cantidad de alimentos para obtener los mejores resultados. El horno calculará automáticamente la configuración óptima y seguirá cambiándola a lo largo del proceso de cocción. El tiempo total no incluye las fases de precalentamiento.

6th SENSE RECALENTAR

Sirve para calentar alimentos precocinados que estén congelados o a temperatura ambiente. El horno calcula automáticamente la configuración requerida para obtener los mejores resultados en el menor tiempo posible. Coloque los alimentos en una bandeja o plato aptos para microondas.

CATEGORÍA	ALIMENTO	PESO
1	BANDEJA DE CENA	250-500 g
2*	PORCIÓN CONGELADA	250-500 g
3*	LASAÑA CONGELADA	250-500 g
4	SOPAS	200-800 g
5	BEBIDAS	1-5 dl

COCCIÓN 6th SENSE

Para cocer rápidamente alimentos y conseguir unos resultados óptimos. Utilice un recipiente resistente al calor y apto para el microondas.

CATEGORÍA	ALIMENTO	PESO
1	PATATAS ASADAS (Gírelas cuando se indique)	200 g-1 kg
2	VERDURAS FRESCAS (Córtelas a trozos del mismo tamaño y añada de 2 a 4 cucharas de agua. Tape)	200-800 g
3*	VERDURAS CONGELADAS (Gire cuando se indique. Tape)	200-800 g
4	VERDURAS EN LATA	200-600 g
5	PALOMITAS	100 g

6th SENSE CRISP

Para calentar y cocinar rápidamente alimentos congelados y darles un gratinado crujiente. Utilice esta función solamente con la bandeja Crisp. Remueva los alimentos cuando lo indique.

CATEGORÍA	ALIMENTO	PESO
1*	PATATAS FRITAS (Extiéndalas en una sola capa y añada sal antes de freírlas)	200-600 g
2*	PIZZA, MASA FINA	200-500 g
3*	PIZZA, MASA GRUESA	300-800 g
4*	ALAS DE POLLO, TROZOS DE POLLO (Engrase el plato ligeramente)	200-600 g
5*	PALITOS DE PESCADO (La bandeja Crisp se tiene que precalentar)	200-600 g

Accesorios necesarios: Bandeja Crisp, asa de la bandeja Crisp

MICROONDAS

Para cocinar y recalentar alimentos o bebidas con rapidez.

POTENCIA	RECOMENDADA PARA
900 W	Calentar rápidamente bebidas u otros alimentos con alto contenido en agua
750 W	Cocción de verduras
650 W	Cocción de carne y pescado
500 W	Cocción de salsas con carne, o salsas que contengan queso o huevo. Acabado de pasteles de carne o pasta al horno
350 W	Cocción lenta y suave. Perfecta para derretir mantequilla o chocolate
160 W	Descongelar alimentos o ablandar mantequilla o queso
90 W	Ablandar helados

AIRE IMPULSADO

Sirve para cocinar platos y obtener un resultado similar al de un horno convencional. Para cocinar ciertos alimentos, se puede emplear el plato para hornear u otros recipientes de cocción aptos para uso en el horno.

Accesorios recomendados: Plato para hornear rectangular, parrilla



CRISP

Para dorar perfectamente un alimento, tanto por arriba como por abajo. Con esta función es necesario utilizar siempre la bandeja Crisp.

Accesorios necesarios: Bandeja Crisp, asa de la bandeja Crisp



JET DEFROST

Para descongelar rápidamente diversos tipos de alimentos simplemente especificando su peso. Los alimentos deben colocarse directamente en el plato giratorio. Remueva los alimentos cuando lo indique.

CATEGORÍA	ALIMENTO	PESO
1*	CARNE (carne picada, chuletas, filetes, asados)	100 g-2 kg
2*	AVES (pollo entero, en trozos o filetes)	100 g-2,5 kg
3*	PESCADO (entero, lomos, filetes)	100 g-2 kg
4*	VERDURAS (verduras variadas, guisantes, brócoli, etc.)	100 g-2 kg
5*	PAN (cortado, panes, bollos)	100 g-1 kg



FUNCIONES MANUALES



CALOR RÁPIDO

Para calentar rápidamente el horno antes de un ciclo de cocción. Espere a que termine la función antes de introducir los alimentos en el horno.



AIRE IMPULS. + MO

Para preparar platos de horno en poco tiempo.

Accesorios necesarios: parrilla



GRILL

Para dorar y gratinar. Es recomendable girar los alimentos durante la cocción. Para obtener los mejores resultados, precaliente el grill durante 3-5 minutos.

Accesorios necesarios: parrilla



GRILL + MICROONDAS

Para cocinar y gratinar rápidamente, combinando las funciones de microondas y las de grill.

Accesorios necesarios: parrilla



TURBO GRILL

Para lograr un resultado perfecto, combinando las funciones de grill y convección del horno. Es recomendable girar los alimentos durante la cocción.

Accesorios necesarios: parrilla



TURBO GRILL + MO

Para cocinar y dorar rápidamente, combinando las funciones de microondas, grill y convección.

Accesorios necesarios: parrilla

PRIMER USO

. AJUSTE DE LA HORA

La primera vez que encienda el aparato, tendrá que ajustar la hora.



Los dos dígitos de la hora empezarán a parpadear: Gire el *selector* para establecer la hora y pulse  para confirmar.





Los dos dígitos de los minutos empezarán a parpadear. Gire el *selector* para establecer los minutos y pulse  para confirmar.

Nota: Para cambiar la hora más adelante, mantenga pulsado  durante como mínimo un segundo con el horno apagado y repita el procedimiento anterior.

Después de un corte de suministro prolongado, es posible que tenga que volver configurar la hora.

USO DIARIO

1. SELECCIONAR UNA FUNCIÓN

Cuando el horno está apagado, la pantalla solo muestra la hora. Mantenga pulsado  para encender el horno. Gire el *selector* para ver las funciones principales disponibles en la pantalla de la izquierda. Seleccione una y pulse .

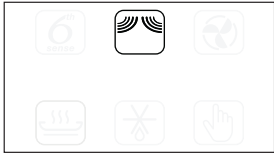

Para seleccionar una subfunción (en caso de que la haya), seleccione la función principal y después pulse  para confirmar e ir al menú de la función.

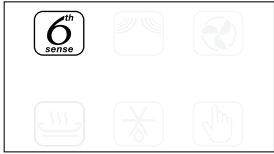

Gire el *selector* para seleccionar una de las subfunciones disponibles en la parte derecha de la pantalla y después pulse  para confirmar.



2. PROGRAMAR UNA FUNCIÓN

. FUNCIONES AUTOMÁTICAS / JET DEFROST

TIPO DE ALIMENTO

Cuando escoja una de las funciones automáticas, tendrá que seleccionar una categoría para los alimentos que cocine.





Cuando el icono  parpadee, gire el *selector* para seleccionar la categoría deseada y confírmela pulsando .

PESO

Para conseguir los mejores resultados, las funciones automáticas (y Jet Defrost) requieren que introduzca el peso de los alimentos seleccionando entre los ajustes preestablecidos: el horno calculará la duración ideal de la función en uso para cada tipo de alimento.



Cuando los valores preestablecidos aparezcan en pantalla y el icono  parpadee, gire el *selector* para programar el peso y después pulse  para confirmar.

. FUNCIONES MANUALES

Cuando haya seleccionado la función que desee, puede cambiar la configuración correspondiente. En la pantalla aparecerá la configuración que se puede cambiar por orden.

POTENCIA / TEMPERATURA DEL MICROONDAS



Cuando el icono **W** parpadee en la pantalla, gire el *selector* para ajustar la configuración de potencia, pulse  para confirmar y siga modificando la configuración siguiente (si es posible).

Nota: Una vez activada la función, la potencia se puede modificar pulsando  para acceder al menú de configuración y después girando el *selector* para cambiar la configuración.

POTENCIA GRILL



Existen tres niveles de potencia para el grill: 1 (bajo), 2 (medio), 3 (alto). El valor por defecto se muestra entre dos símbolos «-» parpadeando.



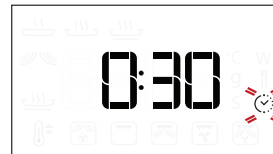

Gire el *selector* para seleccionar el nivel del grill deseado y pulse  para confirmar.

DURACIÓN



Cuando parpadee el icono  en la pantalla, utilice el *selector* para ajustar el tiempo de cocción necesario y luego pulse  para confirmar.

Si quiere cocinar de forma manual no es necesario configurar el tiempo de cocción: Pulse  para confirmar e iniciar la función.

Nota: Durante la cocción, puede ajustar la configuración girando el *selector* cada vez que pulse , el tiempo aumenta en 30 segundos.

CALOR RÁPIDO

Seleccione la función, a continuación utilice el *selector* para programar la temperatura deseada y pulse  para confirmar e iniciar la función.



Cuando el horno alcanza la temperatura programada, se emite una señal acústica.

Nota: Se aconseja no colocar los alimentos en el horno antes del final de esta función.

3. ACTIVAR LA FUNCIÓN

Una vez que haya aplicado la configuración deseada, pulse  para activar la función.

Cada vez que pulse el botón , el tiempo de cocción se incrementará en otros 30 segundos.

Nota: Puede pulsar  en cualquier momento para detener la función que esté activada en ese momento.

. JET START

Cuando el horno está apagado, se puede pulsar  para activar la cocción con la función microondas a la potencia máxima (900 W) durante 30 segundos.

. BLOQUEO DE SEGURIDAD

Esta función se activa automáticamente para evitar la activación accidental del horno.



Abra y cierre la puerta, y pulse  para activar la función.

4. PAUSA

Para detener una función activa, por ejemplo para mover o girar la comida, solamente tendrá que abrir la puerta.

Para reanudar la función, cierre la puerta y pulse .

PAUSA AUTOMÁTICA
(REMOVER O GIRAR LOS ALIMENTOS)

Algunas funciones se detendrán para que pueda remover o girar los alimentos.



Cuando el horno se haya detenido, abra la puerta y lleve a cabo la acción que se le solicite antes de volver a cerrar la puerta y pulsar  para seguir con la cocción.

5. HORA DE FINALIZACIÓN DE LA COCCIÓN

Sonará una señal acústica y la pantalla indicará que la cocción ha terminado.



Para alargar el tiempo de cocción sin cambiar los ajustes, gire el *selector* para programar un nuevo tiempo de cocción y pulse .

. ENFRIAMIENTO

Cuando finaliza una función con aire caliente, el aparato puede realizar un ciclo de enfriamiento. La pantalla muestra el mensaje «Cool on» (enfriando). Tras finalizar dicho ciclo el horno se apaga de forma automática.

Nota: el proceso de enfriamiento se puede interrumpir abriendo la puerta y se puede reanudar, si es necesario, volviéndola a cerrar.

. BLOQUEO DE TECLAS

Para bloquear las teclas, mantenga pulsado  durante al menos 5 segundos.



Para desbloquearlo, siga el mismo proceso.

Nota: El bloqueo de teclas también se puede activar mientras la cocción esté en proceso.

Por motivos de seguridad, el horno se puede apagar en cualquier momento pulsando el botón .

TABLA DE COCCIÓN

ALIMENTO	FUNCIÓN	PRECALENTAR	TEMP. (°C)	POTENCIA (W)	DURACIÓN	ACCESORIOS
Bizcochos		-	160 - 180	-	30 - 60	
		-	160 - 180	90	25 - 50	
Tartas rellenas (tarta de queso, strudel, tarta de manzana)		Sí	160-190	-	35 - 70	
Galletas		Sí	170-180	-	10 - 20	
Merengues		Sí	100-120	-	40 - 50	
Bollos		Sí	210-220	-	10 - 12	
Barra de pan		Sí	180-200	-	30 - 35	
Pizza/Empanada		Sí	190-220	-	20 - 40	
Pizza (0,4-0,5 Kg)		-	-	-	14 - 16	
Tartas saladas (tarta de verduras, quiche Lorraine)		Sí	180-190	-	40 - 55	
Quiche lorraine (1-1,2 kg)		-	-	-	18 - 20	
Lasaña / Pasta al horno		-	-	350 - 500	15 - 40	
Cordero o ternera asados / Rosbif (1,3-1,5 kg)		-	170-180	-	70 - 80*	
		-	160-180	160	50 - 70*	
Rosbif: al punto (1,3-1,5 kg)		-	170-180	-	40 - 60*	
Pollo asado / Conejo / Pato (entero 1-1,2 kg)		-	210-220	-	50 - 70*	
		-	210-220	350	45 - 60*	
Pollo/Conejo/Pato (filetes/piezas 0,4-1 kg)		-	-	350 - 500	20 - 40*	
		-	-	-	12 - 18	
Pescado al horno (entero)		-	-	160 - 350	20 - 40	
Filetes/rodajas de pescado		Sí	-	-	15 - 30*	
Verduras rellenas (tomates, calabacines, berenjenas...)		-	-	500 - 650	25 - 50	
Tostada		-	-	-	3 - 6	
Salchichas/brochetas/costillas/hamburguesas		-	-	-	20 - 40*	
Salchichas / Hamburguesas (0,2-1 kg)		Sí**	-	-	6 - 16	
Patatas asadas		-	-	350 - 500	20 - 40*	
Patatas en cuña (0,3-0,8 kg)		-	-	-	10 - 20	
Fruta asada		-	-	160 - 350	15 - 25	
Verduras gratinadas		-	-	-	15 - 25	
Verduras fritas (0,3-0,8 kg)		Sí**	-	-	8 - 18	

* Dar la vuelta al alimento a mitad de la cocción.

** Precalentar el plato crisp de 3 a 5 minutos.

FUNCIÓNES	Crisp 	Aire impulsado 	Aire impuls. + MO 	Grill 	Grill + Microondas
ACCESORIOS	Plato resistente al calor/ contenedor apto para el microondas 	Parrilla 	Bandeja pastelera rectangular 	Bandeja crisp 	

LIMPIEZA

Asegúrese de que el aparato se haya enfriado antes de llevar a cabo las tareas de mantenimiento o limpieza.

No utilice aparatos de limpieza con vapor.

No utilice estropajos de acero, estropajos abrasivos ni productos de limpieza abrasivos/corrosivos, ya que podrían dañar las superficies del aparato.

SUPERFICIES INTERNAS Y EXTERNAS

- Limpie las superficies con un paño húmedo de microfibra. Si están muy sucias, añada unas gotas de detergente neutro al agua. Seque con un paño seco.
- Limpie el cristal de la puerta con un detergente líquido adecuado.
- Con regularidad, o en caso de salpicaduras, quite el plato giratorio de su soporte para limpiar la parte inferior del horno y eliminar todos los restos de comida.
- No es necesario limpiar el grill ya que la alta temperatura que genera quema toda la suciedad. Utilice esta función con regularidad.

ACCESORIOS

Todos los accesorios son aptos para el lavavajillas, excepto la bandeja Crisp. La bandeja Crisp debe limpiarse con agua y un detergente suave. Para la suciedad más resistente, frote suavemente con un paño. Deje enfriar siempre la bandeja Crisp antes de limpiarla.

RESOLUCIÓN DE PROBLEMAS

Problema	Posible causa	Solución
El horno no funciona.	Corte de suministro. Desconexión de la red eléctrica.	Compruebe que haya corriente eléctrica en la red y que el horno esté enchufado a la toma de electricidad. Apague el horno y vuelva a encenderlo para comprobar si se ha solucionado el problema.
El horno hace ruido, incluso cuando está apagado.	Ventilador de refrigeración activado.	Abra la puerta o mantenga pulsado  .
En la pantalla aparecerá la letra «F» seguida de un número o letra.	Fallo del software.	Póngase en contacto con el Servicio Postventa más cercano e indique la letra o número que aparece después de la letra «F».

TARJETA DE DATOS DEL PRODUCTO

 [www](http://www.docs.whirlpool.eu) La ficha del producto, que incluye los datos de energía de este aparato, se puede descargar en el sitio web docs.whirlpool.eu

CÓMO OBTENER LA GUÍA DE USO Y CUIDADO

>  [www](http://www.docs.whirlpool.eu) Descargue la Guía de uso y cuidado en nuestra página web docs.whirlpool.eu (puede utilizar este código QR), especificando el código del producto.

> También puede ponerse en contacto con nuestro Servicio Postventa



CÓMO PONERSE EN CONTACTO CON NUESTRO SERVICIO POSTVENTA

Encontrará nuestros datos de contacto en el manual de garantía. Cuando se ponga en contacto con nuestro Servicio Postventa, deberá indicar los códigos que figuran en la placa de características de su producto.

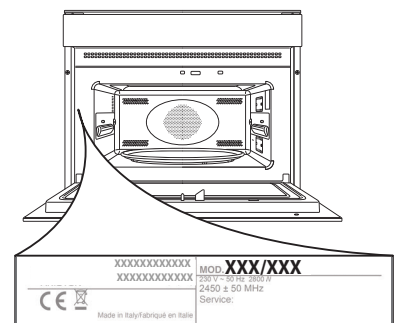

400011091756/B

Printed in Italy

DAGLIG INFORMATIONSBOK



TACK FÖR ATT DU KÖPT EN PRODUKT FRÅN WHIRLPOOL

För att få en mer omfattande kundservice, registrera din produkt på www.whirlpool.eu/register



Du kan ladda ner handböckerna Säkerhetsinstruktioner och Användning och skötsel genom att besöka vår hemsida docs.whirlpool.eu och följa instruktionerna på baksidan av detta häfte.



Läs säkerhetsinstruktionerna noga innan du använder produkten.

BESKRIVNING AV PRODUKTEN

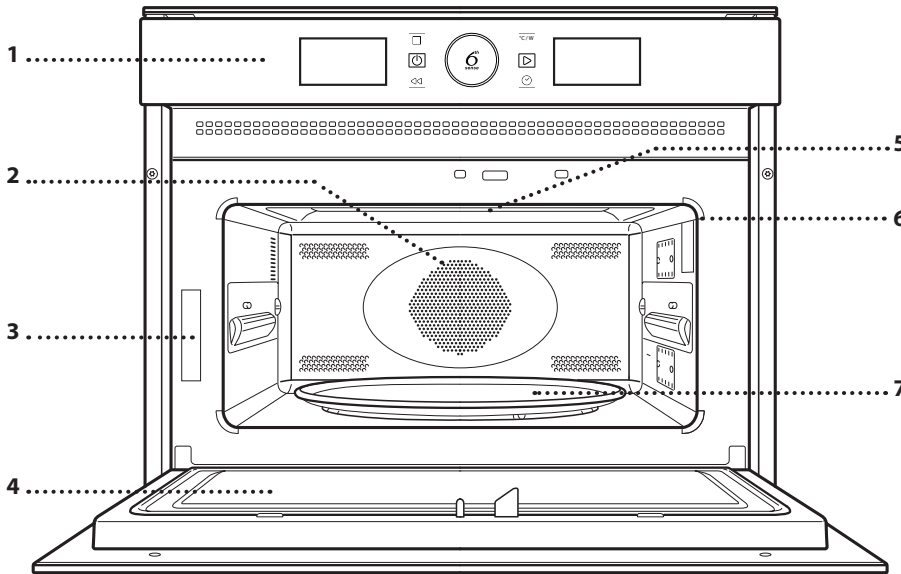

1. Kontrollpanel
2. Runt värmeelement (dolt)
3. Identifieringsskylt (ska inte tas bort)
4. Lucka
5. Övre värmeelement/ grillelement
6. Lätt
7. Roterande glasplatta

KONTROLLPANEL

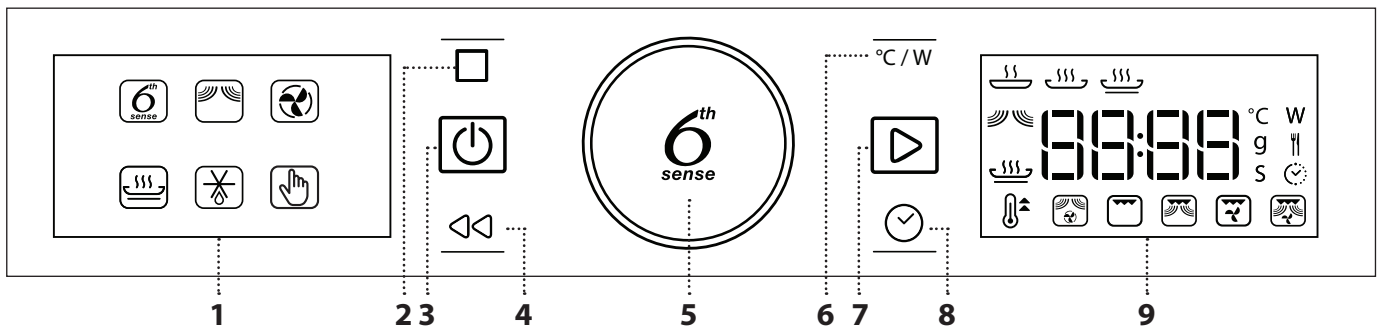

1. VÄNSTER DISPLAY

2. PAUS

För att pausa tillagningen

3. PÅ/AV

För att sätta på och stänga av ugnen eller stoppa en aktiv funktion när som helst.

4. TILLBAKA

För återgång till föregående skärm.

5. RATT / 6th SENSE-KNAPP

Vrid på reglaget för att rulla funktionerna och ställa in alla tillagningsparametrar. Tryck på  för att välja, ställa in, få återkomst till och bekräfta funktioner eller parametrar och för att starta tillagningsprogrammet.

6. EFFEKT

För att justera temperaturen, grillnivån eller mikrovågseffekten.

7. START

För att starta funktioner och bekräfta inställningar

8. TID

För att ställa tiden samt för att ställa in och justera tillagningstiden.

9. HÖGER DISPLAY

TILLBEHÖR

ROTERANDE GLASPLATTA

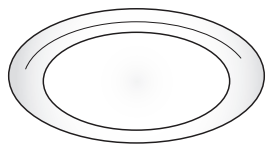

Placerad på dess stöd kan den roterande glasplattan användas med alla tillagningsmetoder. Den roterande glasplattan ska alltid användas som underlag till andra behållare eller tillbehör,

med undantag för den rektangulära bakplåten.

RULLSTÖD

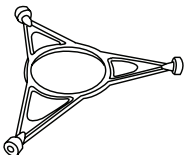

Använd endast stödet till den roterande glasplattan. Ställ inte andra tillbehör på stödet.

CRISPPANNA

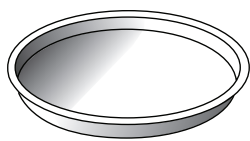

Bara för användning med den avsedda funktionen. Crispplattan måste alltid placeras mitt på glastallriken och kan förvärmas när den är tom, med hjälp av specialfunktionen endast för detta ändamål. Lägg maten direkt i crisppannan.

HANDTAG FÖR CRISPPANNAN

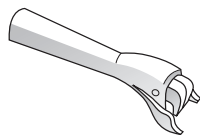

Används för att ta ut den heta crisppannan ur ugnen.

BAKGALLER

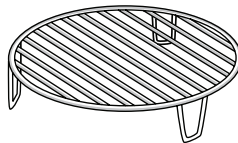

Används för att placera maten närmare grillen, för en perfekt bryning av maten. Placera gallret på den roterande glasplattan och se till att det inte kommer i kontakt med andra ytor.

REKTANGULÄR BAKPLÅT

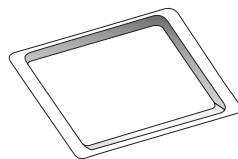

Använd endast bakplåten med funktioner som tillåter tillagning med varmluft. Den får aldrig användas i kombination med mikrovågor. Sätt in plattan horisontellt, låt

den vila på gallret i ugnsutrymmet.

Observera: Du behöver inte ta bort den roterande glasplattan och dess stöd när du använder den rektangulära bakplåten.

Antalet och typ av tillbehör kan variera beroende på modellen du köpt. Andra tillbehör som inte medföljer kan köpas separat. Vänd dig till vår kundservice.

På marknaden finns det många olika sorters tillbehör. Kontrollera att de är lämpliga för mikrovågsugnar och tål ugnstemperaturer innan du köper dem.

Metallbehållare för mat eller dryck ska aldrig användas vid tillagning i mikrovågsugn.

Se alltid till att livsmedel och tillbehör inte kommer i kontakt med innerväggarna i ugnen.

Kontrollera alltid att glasplattan kan snurra obehindrat innan du startar ugnen. Se till att den roterande glasplattan inte hamnar utanför avsedd plats när du sätter i eller tar ut andra tillbehör.

FUNKTIONER



6th SENSE-FUNKTIONER

Med 6th Sense-funktionerna behöver du bara välja matens typ och vikt eller mängd för att uppnå bästa möjliga resultat. Ugnen beräknar automatiskt de optimala inställningarna och fortsätter att ändra dem medan tillagningen fortskrider.

Den totala tiden inkluderar inte förvärmningsfaserna.

6th SENSE VÄRMNING

För att värma färdiglagad mat som antingen är fryst eller har rumstemperatur. Ugnen beräknar automatiskt de inställningar som krävs för att uppnå bästa möjliga resultat på kortast möjliga tid. Lägg maten på en mikrovågssäker och värmetålig tallrik eller fat.

KATEGORI	MAT	VIKT
	MIDDAGSRÄTT	250 g - 500 g
	FRYST MATPORTION	250 g - 500 g
	FRYST LASAGNE	250 g - 500 g
	SOPPOR	200 g - 800 g
	DRYCKER	1 - 5 dl

6th SENSE TILLAGNING

För snabb tillagning av mat och för optimala resultat. Använd ett värmetåligt kärl lämpligt för användning i mikrovågsugn.

KATEGORI	MAT	VIKT
	BAKAD POTATIS (Vänd när du uppmanas till det)	200 g - 1 kg
	FÄRSKA GRÖNSAKER (Skär i bitar av samma storlek och tillsätt 2 till 4 matskedar vatten. Täck med lock)	200 g - 800 g
	FRYSTA GRÖNSAKER (Vänd när du uppmanas till det. Täck med lock)	200 g - 800 g
	KONSERVERADE GRÖNSAKER	200 g - 600 g
	POP CORN	100 g

6th SENSE CRISP

För att snabbt värma upp och tillaga frysta livsmedel så att de får en gyllenbrun och knaprig yta. Använd denna funktion endast med den medföljande crisppannan. Vänd maten när ugnen uppmanar dig till det.

KATEGORI	MAT	VIKT
	POMMES FRITES (sprid ut dem i ett lager och salta dem före tillagningen)	200 g - 600 g
	PIZZA, TUNN BOTTEN	200 g - 500 g
	PIZZA, TJOCK BOTTEN	300 g - 800 g
	KYCKLINGVINGAR, KYCKLINGBITAR (Smörj pannan något)	200 g - 600 g
	FISKPINNAR (Crisppannan ska förvärmas)	200 g - 600 g

Nödvändiga tillbehör: Crisppanna, handtag för crisppannan

MIKROVÅGOR

För att snabbt laga och värma mat eller dryck.

EFFEKT	REKOMMENDERAS FÖR
900 W	Snabb uppvärmning av drycker eller andra livsmedel med hög vattenhalt
750 W	Koka grönsaker
650 W	Tillaga kött och fisk
500 W	Tillaga köttsåser eller såser som innehåller ost eller ägg. Slutbereda köttpajer eller ugnsbakad pasta
350 W	Långsam, varsam tillagning. Perfekt för att smälta smör eller choklad
160 W	Upptining av djupfrysta livsmedel eller mjuka upp smör och ost
90 W	Mjuka upp glass

VARMLUFT

För tillagning av rätter på ett sätt som ger liknande resultat som med en konventionell ugn. Bakplåten eller annat kärl som lämpar sig för ugnsbak brukar användas för att laga vissa livsmedel.

Rekommenderade tillbehör: Rektangulär bakplåt, galler



CRISP

För att bryna en maträtt perfekt, både på matens ovan- och undersida. Denna funktion får endast användas med den speciella crisppannan.

Nödvändiga tillbehör: Crisppanna, handtag för crisppannan



JET DEFROST

För snabb upptining av olika slags mat genom att helt enkelt ange dess vikt. Maten ska placeras direkt på den roterande glasplattan. Vänd maten när ugnen uppmärskar dig till det.

KATEGORI	MAT	VIKT
1*	KÖTT (köttfärs, kotletter, biflar, stekar)	100 g - 2 kg
2*	KYCKLING (kyckling hel, delar eller filéer)	100 g - 2,5 kg
3*	FISK (hel, i skivor eller filéer)	100 g - 2 kg
4*	GRÖNSAKER (blandade grönsaker, ärtor, broccoli osv.)	100 g - 2 kg
5*	BRÖD (limpor, bullar, kuvertbröd)	100 g - 1 kg



MANUELLA FUNKTIONER



SNABB UPPVÄRMNING

För att snabbt värma upp ugnen innan tillagningen. Vänta tills uppvärmningen är färdig innan du lägger in maten i ugnen.



VARMLUFT + MIKRO

För att laga ugnsrätter på kort tid.

Nödvändiga tillbehör: Galler



GRILL

För att bryna, grilla och gratinera. Vi rekommenderar att vända maten under tillagningen. För bästa resultat, förvärm grillen i 3-5 minuter.

Nödvändiga tillbehör: Galler



GRILL + MIKRO

För snabb matlagning och gratinering av rätter där man kombinerar mikrovågs- och grillfunktionen.

Nödvändiga tillbehör: Galler



TURBO GRILL

För perfekta resultat, kombinera grill- och varmluftsfunktionerna. Vi rekommenderar att vända maten under tillagningen.

Nödvändiga tillbehör: Galler



TURBOGRILL + MIKRO

För snabb matlagning och bryning av maten genom att kombinera mikrovågs-, grill- och varmluftsfunktionerna.

Nödvändiga tillbehör: Galler

ANVÄNDNING FÖRSTA GÅNGEN

. STÄLLA KLOCKAN

Du kommer att behöva ställa in tiden när du slår på ugnen för första gången.



De två siffrorna för timmen börjar blinka: Vrid ratten för att ställa in tiden och tryck sedan på för att bekräfta.





De två siffrorna för minuterna börjar blinka. Vrid ratten för att ställa in minuterna och tryck på för att bekräfta.

Observera: För att ändra tiden vid ett senare tillfälle, tryck på och håll den intryckt i minst en sekund när ugnen är avstängd och upprepa stegen ovan.

Du kan behöva ställa in klockan igen efter långa strömavbrott.

DAGLIG ANVÄNDNING

1. VÄLJ ÖNSKAD FUNKTION

När ugnen är avstängd visas bara tiden på displayen. Tryck på  och håll den intryckt för att sätta på ugnen. Vrid *ratten* för att visa de tillgängliga huvudfunktionerna på vänster display. Välj en och tryck på .

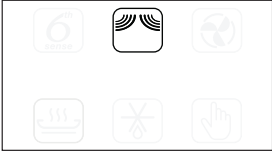

För att välja en underfunktion (om tillgänglig), välj en huvudfunktion och tryck sedan på  för att bekräfta och gå till funktionsmenyn.





Vrid *ratten* för att välja bland tillgängliga underfunktioner på displayen till höger och tryck sedan på  för att bekräfta.

2. STÄLLA IN EN FUNKTION

. AUTOMATISKA FUNKTIONER / JET DEFROST MATKLASS

När du valt en av de automatiska funktionerna behöver du välja en kategori för den mat du ska tillaga.





När  ikonen blinkar, vrid på *ratten* för att välja önskad kategori och tryck sen på  för att bekräfta.

VIKT

För att uppnå bästa resultat kräver de automatiska funktionerna (och Jet Defrost) att du anger matens vikt genom att välja bland standardinställningarna: ugnen räknar då ut den idealiska tiden för tillagning av varje matkategori.



När standardinställningarna visas på displayen och  ikonen blinkar, vrid på *ratten* för att ställa in vikten och tryck sen på  för att bekräfta.

.MANUELLA FUNKTIONER

Efter att ha valt önskad funktion kan du ändra dess inställningar. Displayen visar inställningarna som kan ändras i sekvens.

MIKROVÅGSEFFEKT / TEMPERATUR



När ikonen **W** blinkar på displayen, vrid *ratten* för att justera inställd effekt och tryck sedan på  för att bekräfta och ändra nästa inställning (om möjligt).

Observera: När väl funktionen aktiverats kan effekten ändras genom att trycka på  för att få tillgång till inställningsmenyn och sen trycka på *ratten* för att ändra inställningen.

GRILLEFFEKT

Det finns tre definierade effektnivåer för grill: 1 (låg), 2 (mellan), 3 (hög). Standardvärdet visas mellan två blinkande symboler "- -".



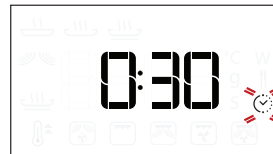

Vrid *ratten* för att ställa in önskad grillnivå och tryck sedan på  för att bekräfta.

TIDSLÄNGD



När ikonen  blinkar på displayen, använd *ratten* för att ställa in önskad tillagningstid och tryck sedan på  för att bekräfta.

Du behöver inte ställa in tillagningstiden om du vill hantera tillagningen manuellt: Tryck på  för att bekräfta och starta funktionen.

Obs: Under tillagning kan du justera tillagningstiden genom att vrida på *ratten*; varje gång du trycker på , ökar tillagningstiden med 30 sekunder.

SNABBVÄRME

Välj funktionen, vrid sedan *ratten* för att ställa in önskad måltemperatur och tryck på  för att bekräfta och starta funktionen.



När ugnen når måltemperaturen avges en summer.

Observera: Vi råder till att inte lägga in maten i ugnen förrän denna funktion har slutförts.

3. AKTIVERA FUNKTIONEN

När du har angivit alla inställningar som behövs, tryck på  för att aktivera funktionen.

Varje gång som knappen  trycks in igen ökar tillagningstiden med ytterligare 30 sekunder.

Observera: Du kan trycka på  när som helst för att stoppa funktionen som är aktiv för tillfället.

. JET START

När ugnen är avstängd kan man trycka på  för att aktivera tillagning med mikrovågsfunktionen inställd på full effekt (900 W) i 30 sekunder.

. KNAPPLÅS

Den här funktionen aktiveras automatiskt för att förhindra att ugnen slås på av misstag.



Öppna och stäng luckan och tryck sedan på  för att starta funktionen.

4. PAUS

Om du vill pausa en aktiv funktion, t.ex. för att röra om eller vända maten, behöver du bara öppna luckan.

För att starta den igen, stäng luckan och tryck på .

AUTOMATISK PAUS

(RÖR OM ELLER VÄND MATEN)

Vissa funktioner kommer att pausa för att tillåta att du vänder eller rör om i maten.



Öppna luckan när ugnen har pausat tillagningen. Utför åtgärden som ugnen uppmanar dig att göra innan du stänger luckan igen och trycker på  för att fortsätta tillagningen.

5. TILLAGNINGSTIDENS SLUT

En ljudsignal avges och displayen talar om att tillagningen är klar.



För att förlänga tillagningstiden utan att ändra inställningarna, vrid *ratten* för att ställa in en ny tillagningstid och tryck på .

. NEDKYLNING

När en funktion med varmluft har avslutats kan det hända att apparaten kör en nedkylningsprocedur. På displayen visas "Cool On". Efter denna procedur stängs ugnen av automatiskt.

Observera: Om luckan öppnas avbryts nedkylningsförfarandet. Om nödvändigt aktiveras det igen när luckan stängs.

. TANGENTLÅS

För att låsa knappsatsen, tryck på  och håll den intryckt i minst 5 sekunder.































































Gör det igen för att låsa upp knappsatsen.

Observera: Tangentlåset kan även aktiveras medan tillagningen pågår.









Av säkerhetsskäl kan ugnen stängas av när som helst genom att hålla knappen  intryckt.

TILLAGNINGSTABELL

MAT	FUNKTION	FÖRVÄRMNING	TEMP. (°C)	EFFEKT (W)	TIDSLÄNGD	TILLBEHÖR
Tårter		-	160 - 180	-	30 - 60	
		-	160 - 180	90	25 - 50	
Fyllda pajer (ostkaka, äppelstrudel, äppelpaj)		Ja	160-190	-	35 - 70	
Kakor		Ja	170-180	-	10 - 20	
Maränger		Ja	100-120	-	40 - 50	
Brödbullar		Ja	210-220	-	10 - 12	
Limpa bröd		Ja	180-200	-	30 - 35	
Pizza/Paj		Ja	190-220	-	20 - 40	
Pizza (0,4-0,5 kg)		-	-	-	14 - 16	
Matpajer (grönsakspaj, Quiche Lorraine)		Ja	180-190	-	40 - 55	
Quiche Lorraine (1-1,2 kg)		-	-	-	18 - 20	
Lasagne/ugnsbakad pasta		-	-	350 - 500	15 - 40	
Lammstek / kalv / rostbiff (1,3-1,5 kg)		-	170-180	-	70 - 80*	
		-	160-180	160	50 - 70*	
Rostbiff - medium (1,3-1,5 kg)		-	170-180	-	40 - 60*	
Grillad kyckling / kanin / anka (hel 1-1,2 kg)		-	210-220	-	50 - 70*	
		-	210-220	350	45 - 60*	
Kyckling / kanin / anka (filéer / bitar 0,4-1 kg)		-	-	350 - 500	20 - 40*	
		-	-	-	12 - 18	
Ugnsstekt fisk (hel)		-	-	160 - 350	20 - 40	
Fiskfiléer / skivor		Ja	-	-	15 - 30*	
Fyllda grönsaker (tomater, squash, aubergin)		-	-	500 - 650	25 - 50	
Rostat bröd		-	-	-	3 - 6	
Korv/grillspett/revbensspjäll/hamburgare		-	-	-	20 - 40*	
Korvar/burgare (0,2-1 kg)		Ja**	-	-	6 - 16	
Ugnsbakad potatis		-	-	350 - 500	20 - 40*	
Potatisklyftor (0,3-0,8 kg)		-	-	-	10 - 20	
Bakad frukt		-	-	160 - 350	15 - 25	
Gratinerade grönsaker		-	-	-	15 - 25	
Stekta grönsaker (0,3-0,8 kg)		Ja**	-	-	8 - 18	

* Vänd maten efter halva tiden.

** Förvärm crisppannan i 3-5 minuter.

FUNKTIONER	Crisp 	Varmluft 	Varmluft + Mikro 	Grill 	Grill + Mikro 
TILLBEHÖR	Värmetålig platta/behållare som lämpar sig för användning i mikrovågsugn 	Bakgaller 	Rektangulär bakplåt 	Crisppanna 	

RENGÖRING

Se till att apparaten har svalnat innan du utför underhåll eller rengöring.

Använd inte ångtvätt.

Använd inte stålull, slipsvampar eller slipande/frätande rengöringsmedel, eftersom dessa kan skada apparatens ytor.

INRE OCH YTTRE YTOR

- Rengör ytorna med en fuktig trasa av mikrofiber. Om de är mycket smutsiga, tillsätt några droppar pH-neutralt rengöringsmedel. Torka med en torr duk.
- Rengör luckans glas med ett lämpligt flytande rengöringsmedel.
- Med jämna mellanrum, eller vid spill, ta bort den roterande glasplattan och sitt stöd för att rengöra ugnens botten för att ta bort alla matrester.
- Grillen behöver inte rengöras eftersom den intensiva hettan bränner bort all smuts. Använd denna funktion på en regelbunden basis.

TILLBEHÖR

Alla tillbehör kan maskindiskas med undantag av crisppannan. Crisppannan skall rengöras med vatten och ett mildt diskmedel. För envist smuts, gnugga försiktigt med en trasa. Låt alltid crisppannan svalna innan du rengör den.

FELSÖKNING

Problem	Möjlig orsak	Lösning
Ugnen fungerar inte.	Strömavbrott. Frånkopplad från elnätet.	Kontrollera att ström finns och att ugnen är ansluten till elnätet. Stäng av ugnen och slå på den igen för att se om felet kvarstår.
Ugnen avger ljud, även när den är avstängd.	Kylfläkten är på.	Öppna luckan eller håll  .
Displayen visar bokstaven "F" följt av en bokstav eller ett nummer.	Programvarufel.	Kontakta närmaste kundservice och ange bokstaven eller numret som följer bokstaven "F".

PRODUKTBLAD

 [www](http://www.docs.whirlpool.eu) Produktbladet med energiförbrukningen för denna apparat kan laddas ner från webbplatsen docs.whirlpool.eu

HUR DU FÅR TAG PÅ HANDBOKEN ANVÄNDNING OCH SKÖTSEL

>  Ladda ner handboken Användning och skötsel från vår webbplats docs.whirlpool.eu (du kan använda denna QR-kod) och ange produktens handelskod.

> Du kan även kontakta vår kundservice



KONTAKTA VÅR KUNDSERVICE

Du hittar våra kontaktuppgifter i garantihäftet. När du kontaktar vår kundservice, ange koderna som står på produktens typskylt.

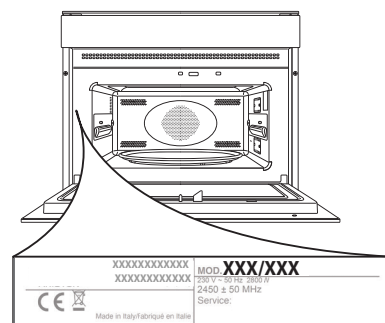

400011091756/B

Printed in Italy