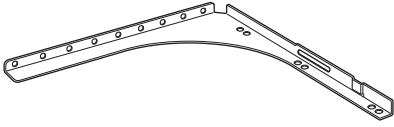
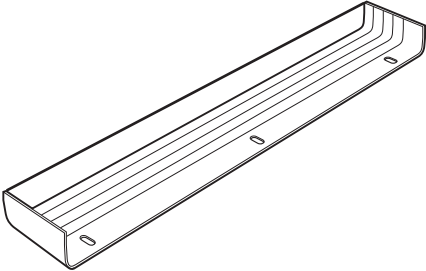
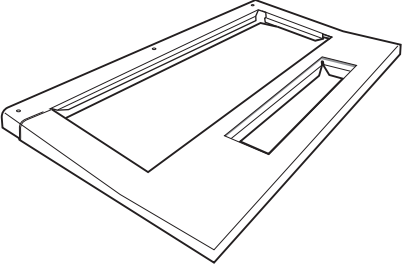
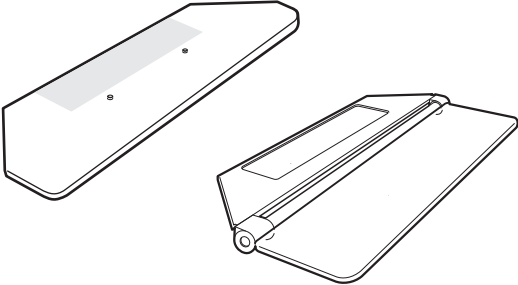
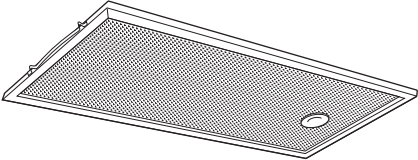

A  2x

B  1x

C  1x

D  1x

E  1x

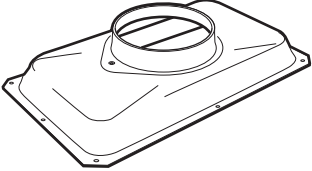
F  1x

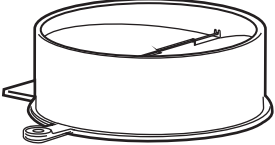
G  1x

H  6x

I  23x

J  2x

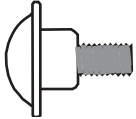
K  2x

L  2x

M  1x

N  4x

O  1x

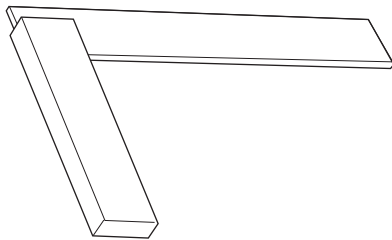
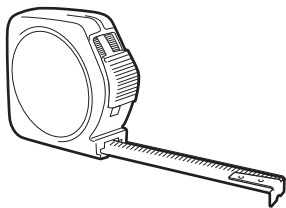
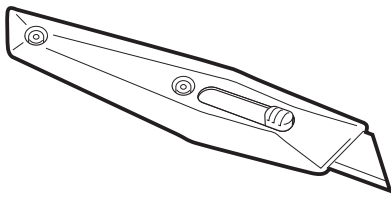
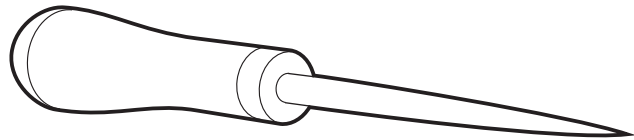
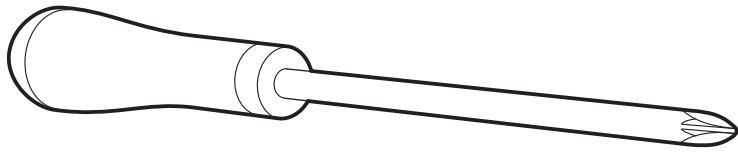

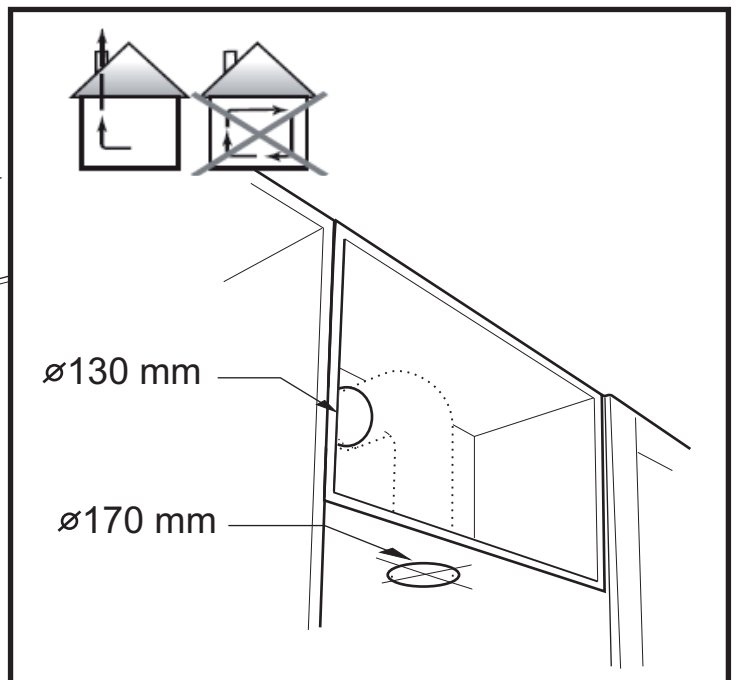
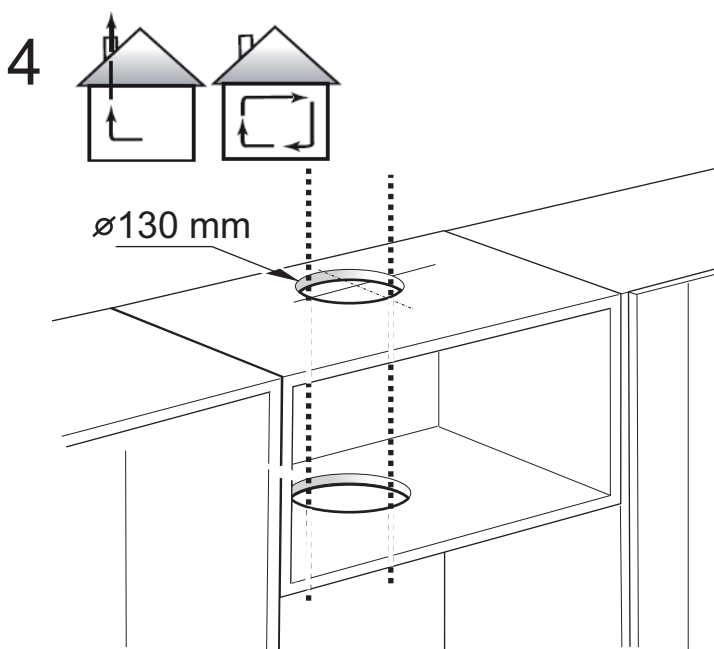
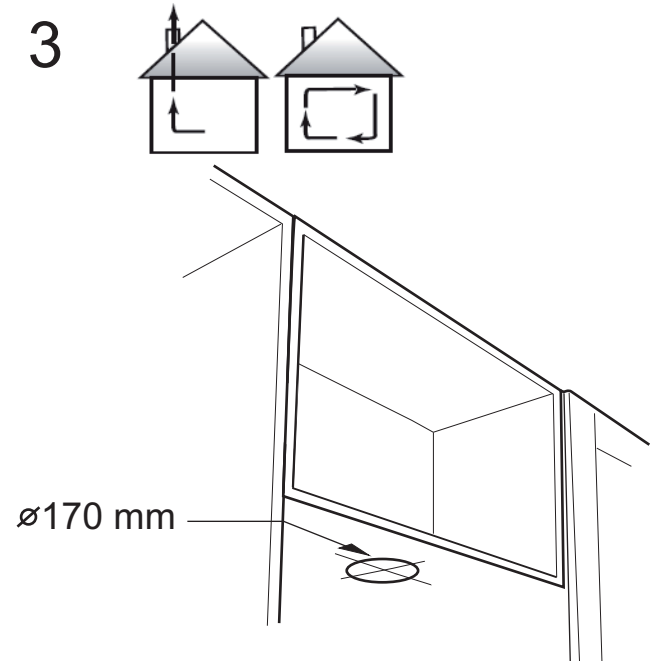
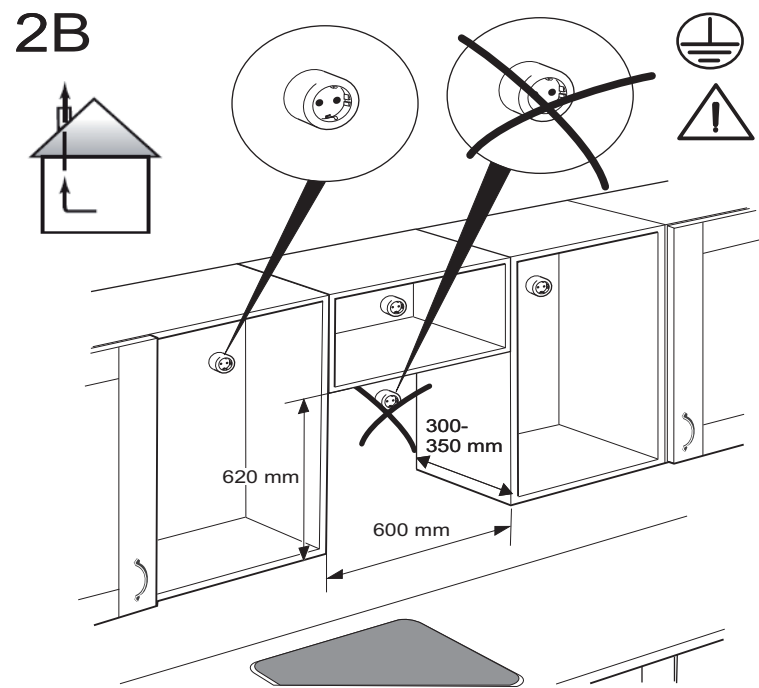
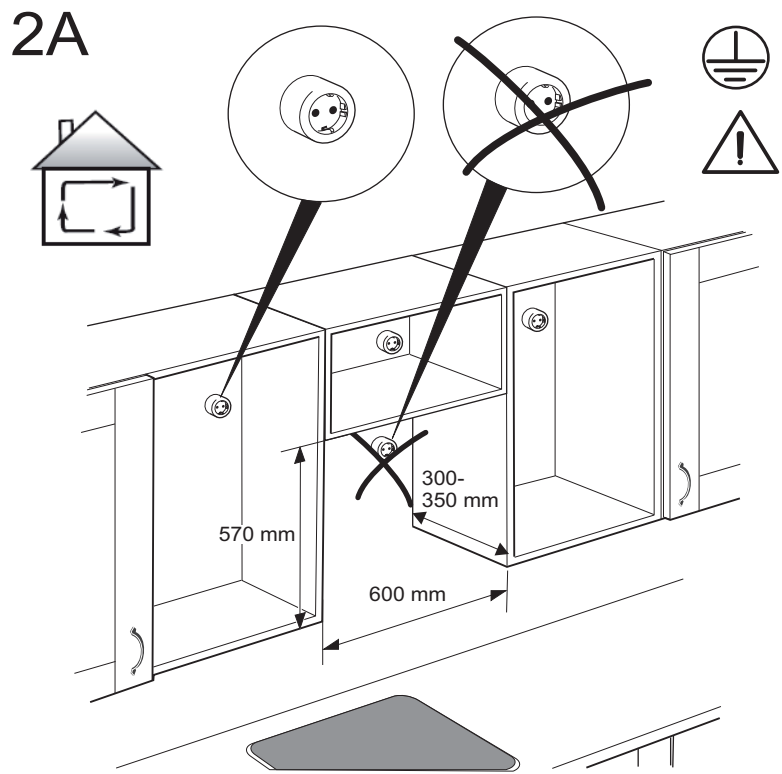
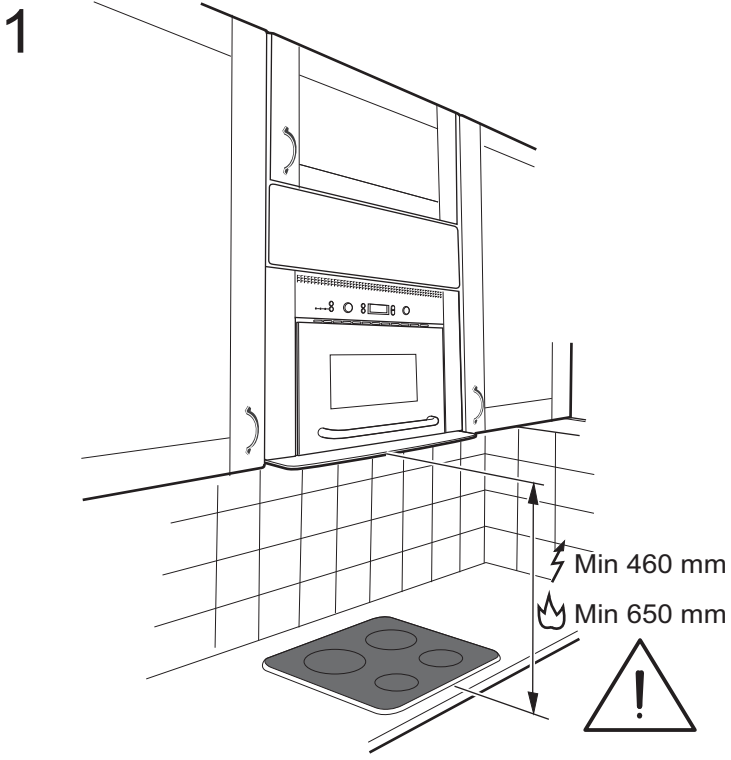

5

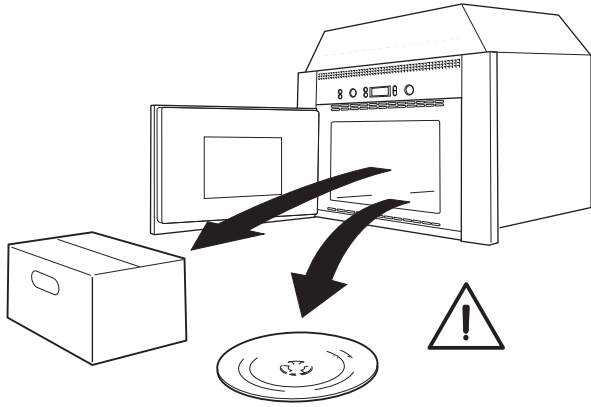

6A

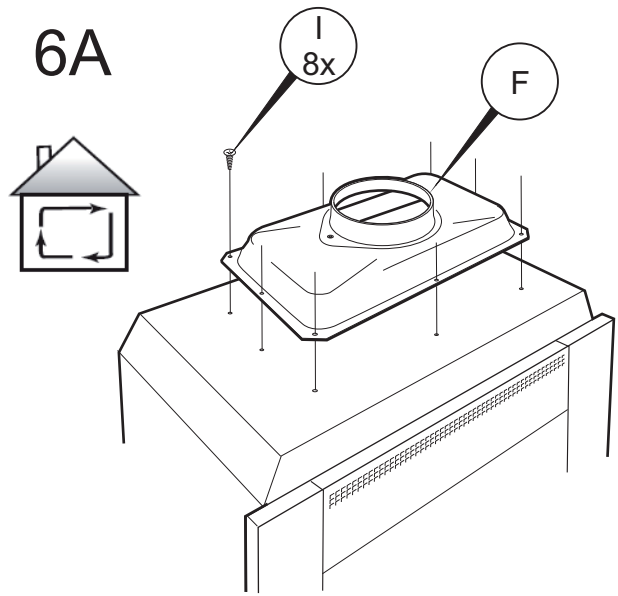

6B

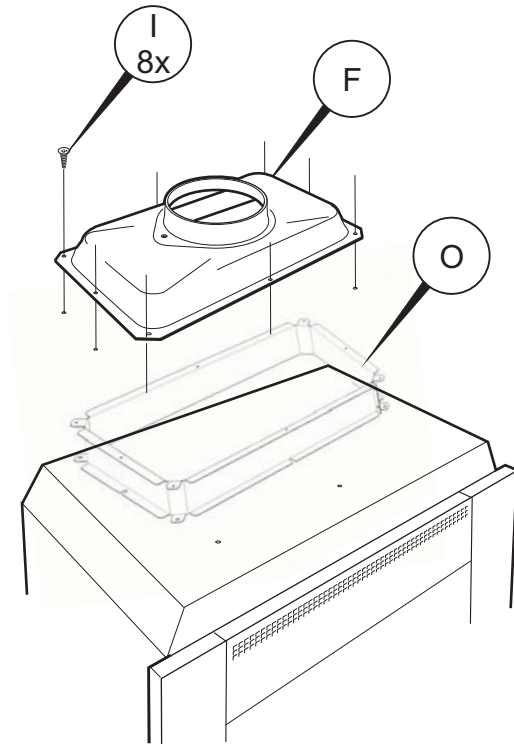

7

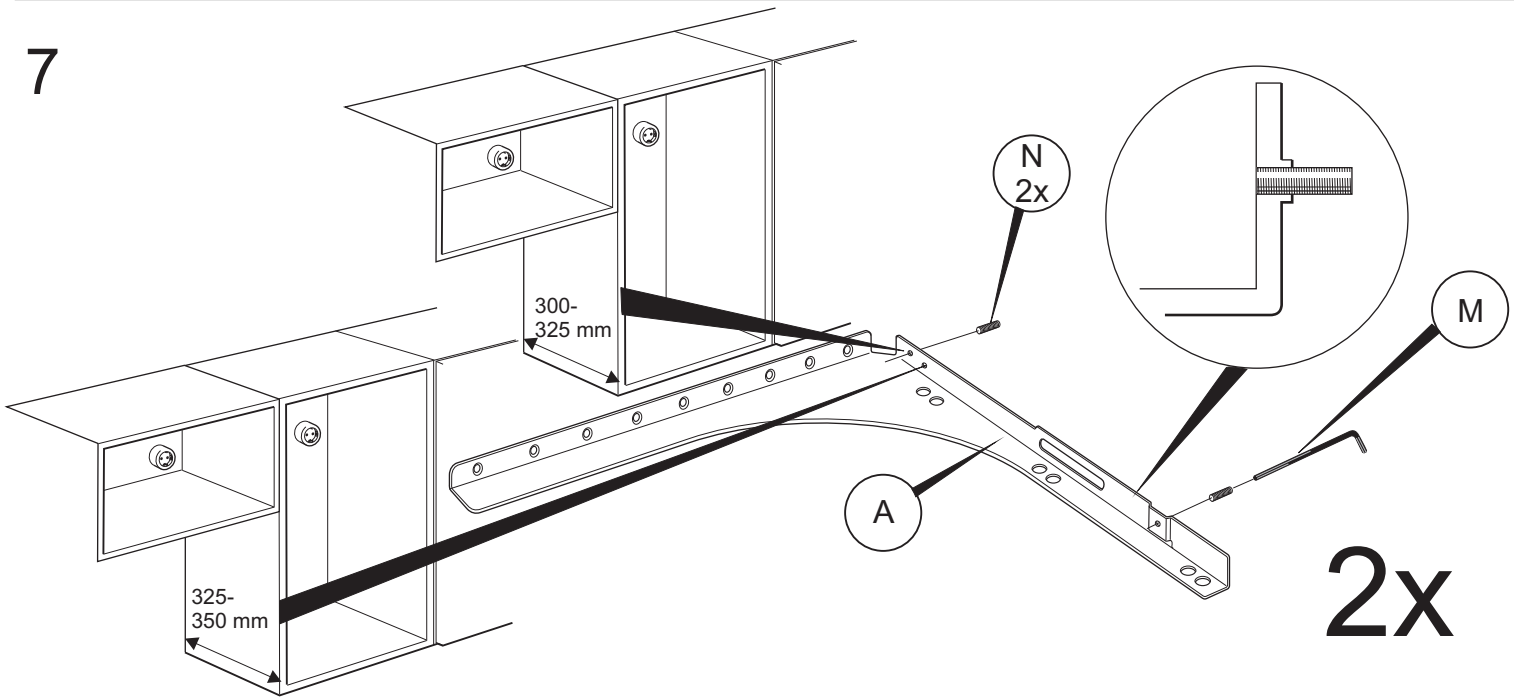

8a

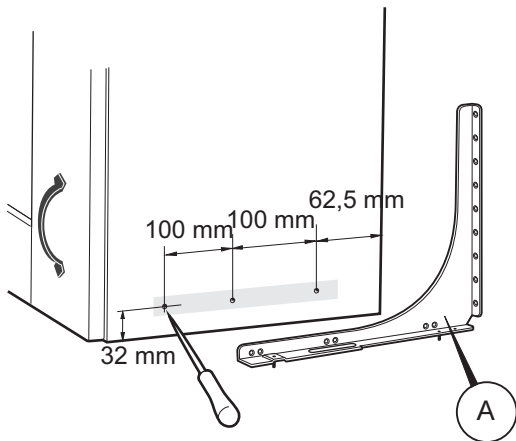

8b

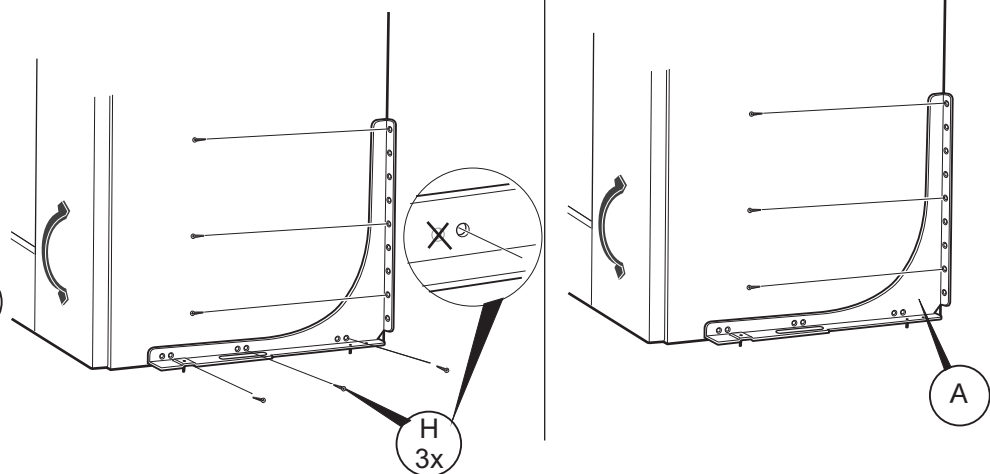

9a

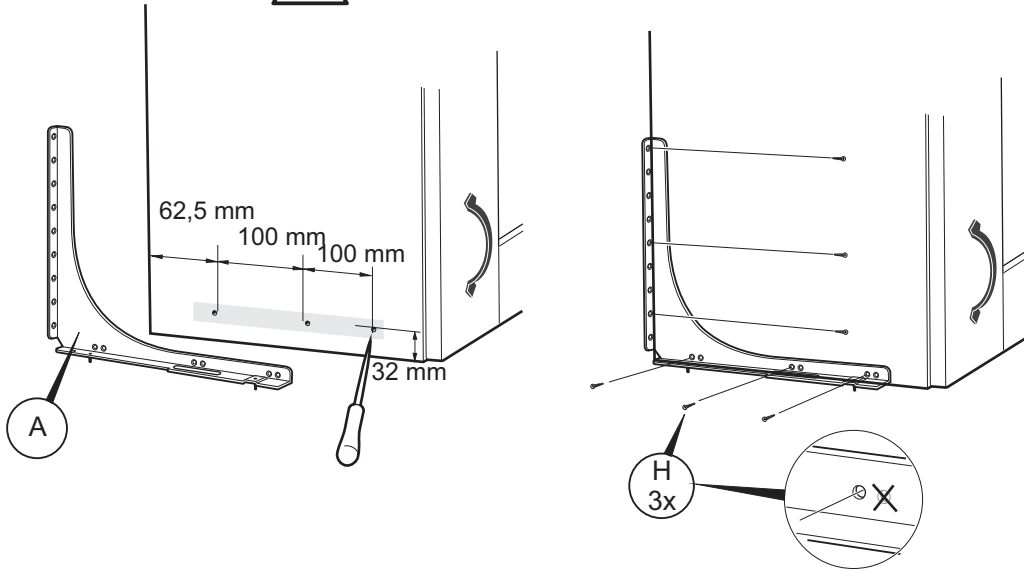

9b

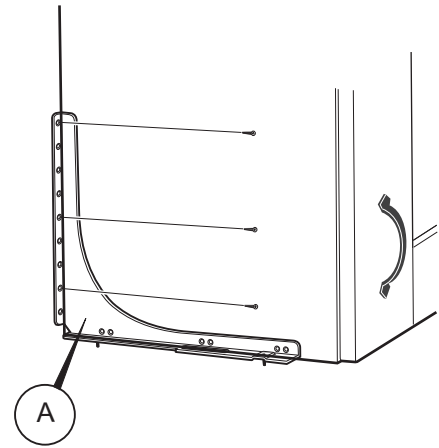

10

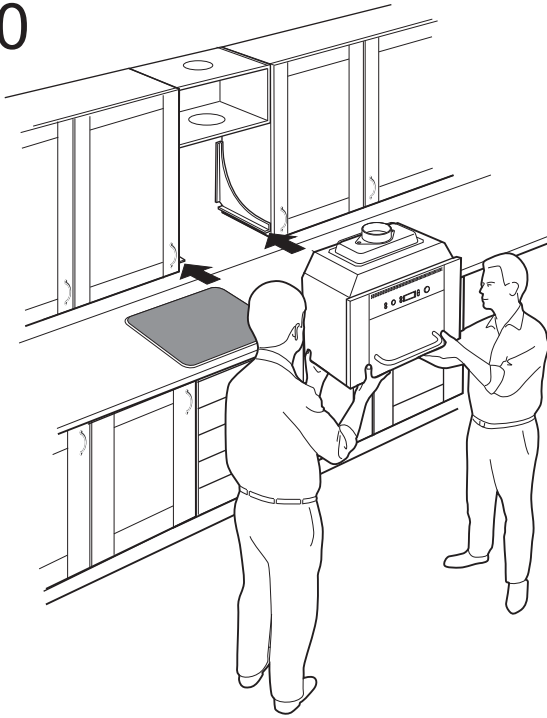

11

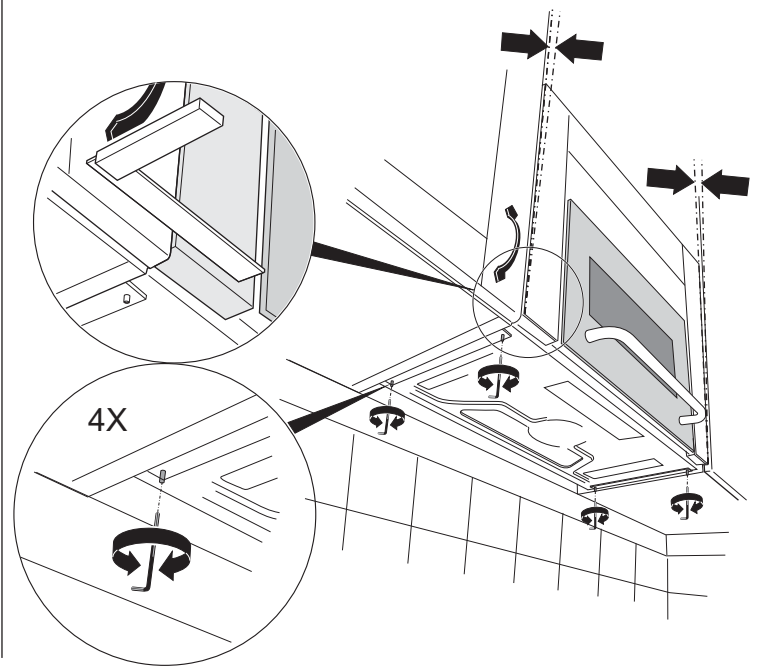

12

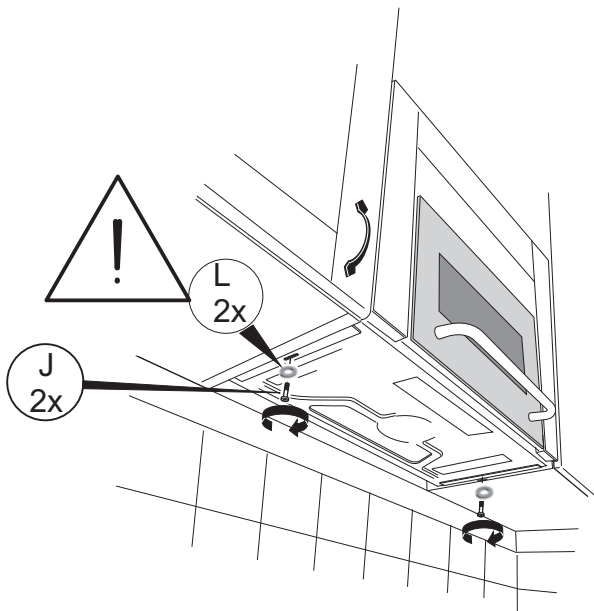

13

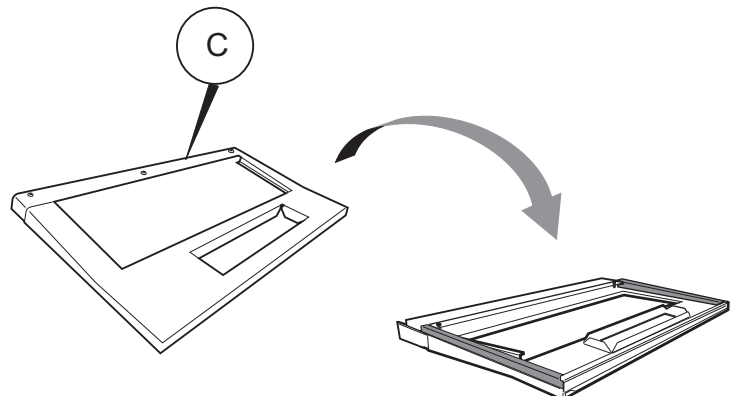

14

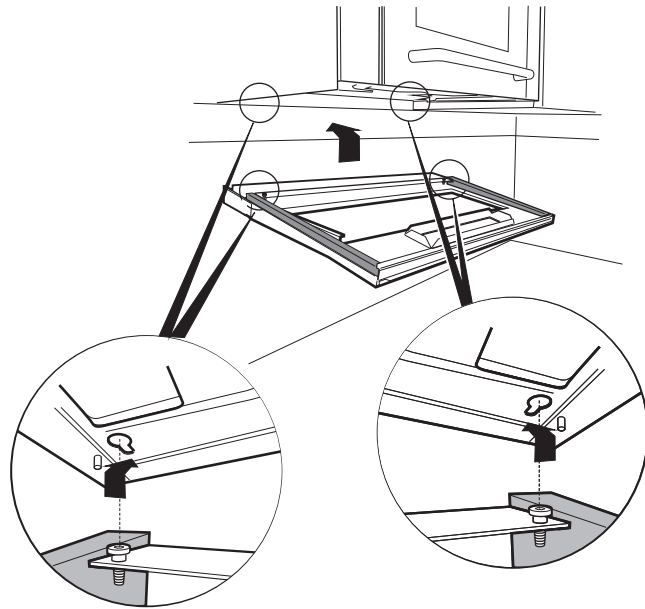

15

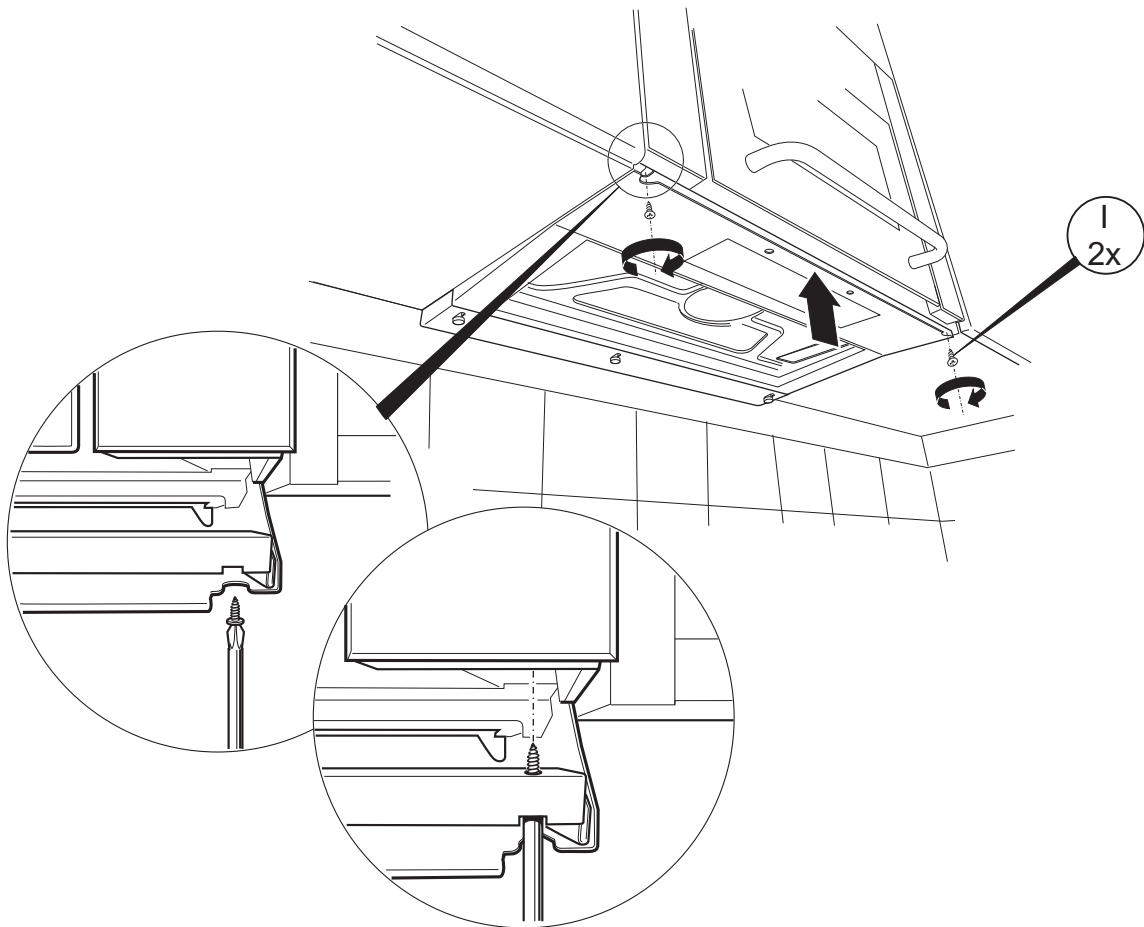



16

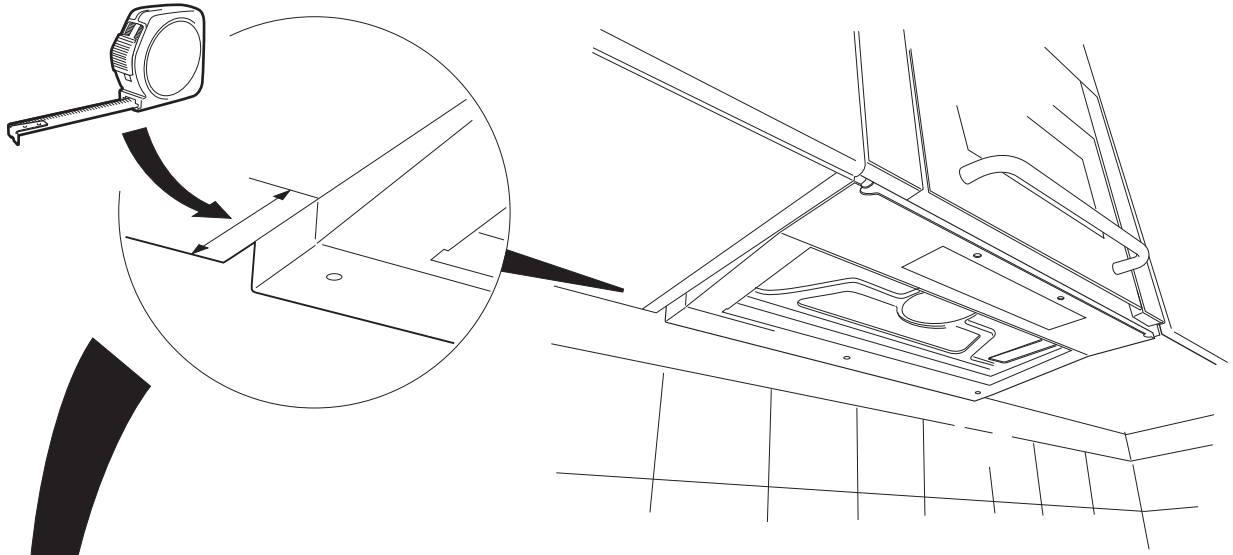

17

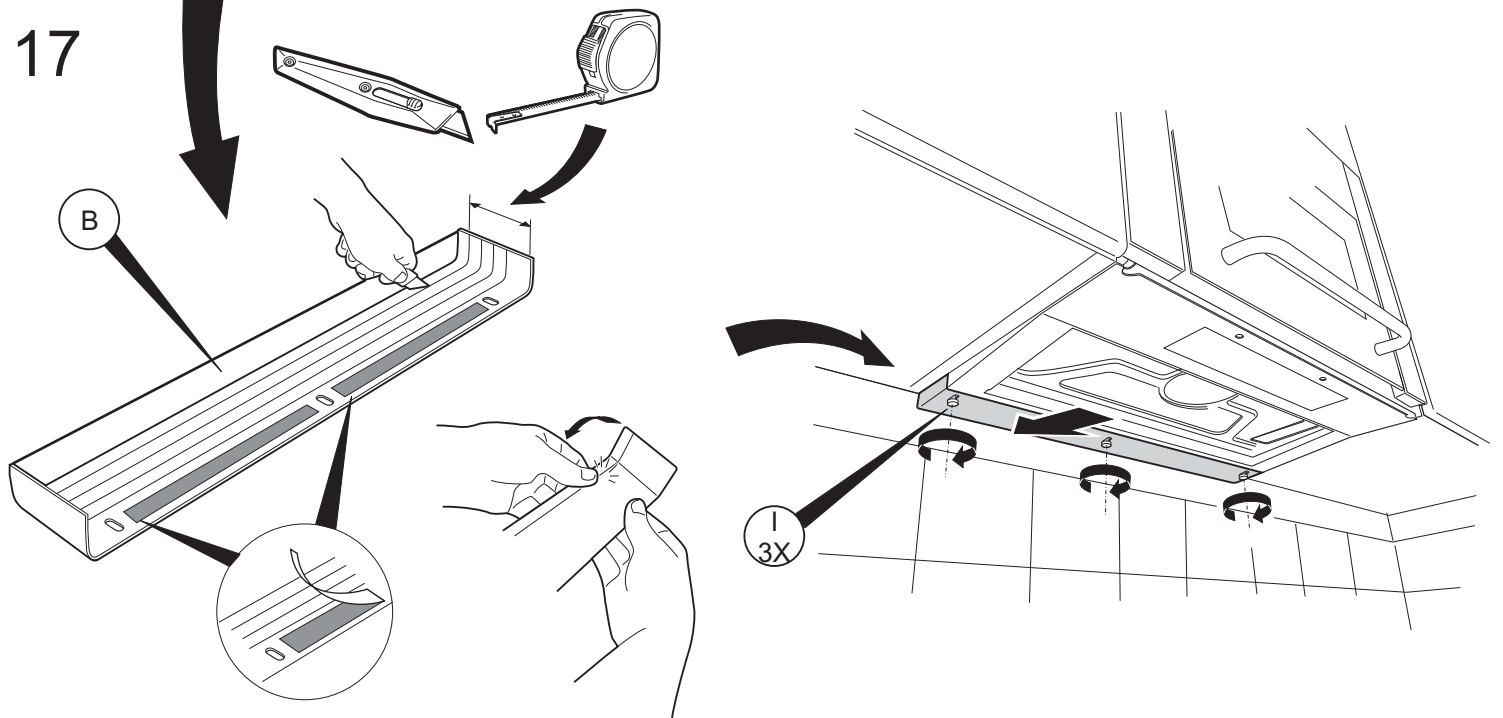

18a

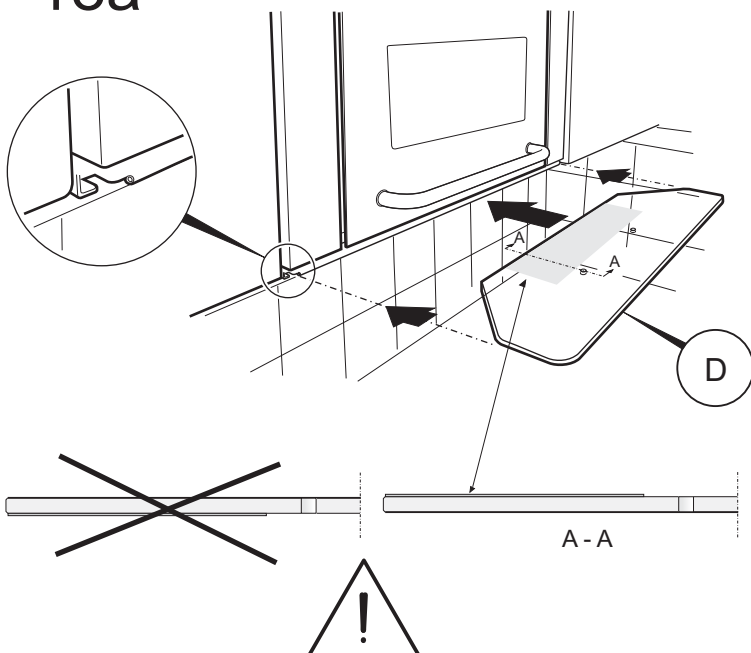

18b

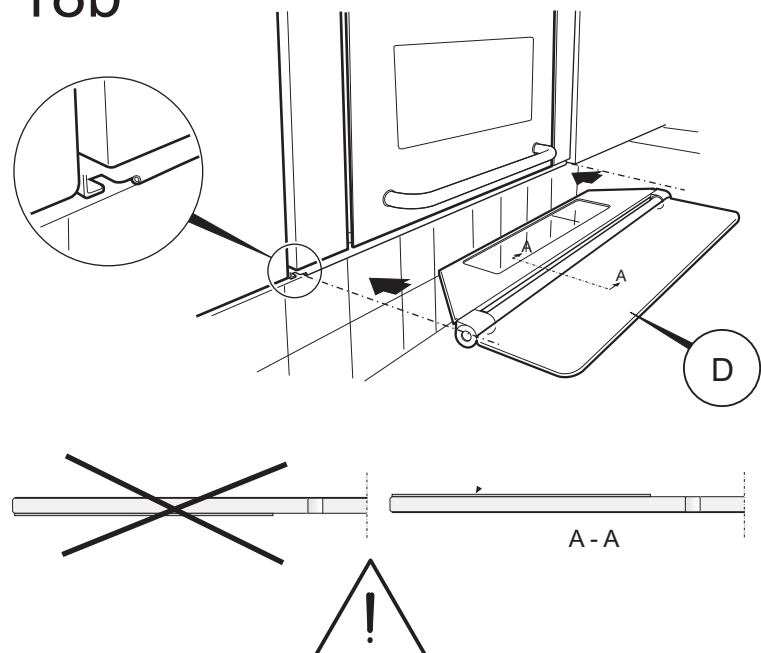

19

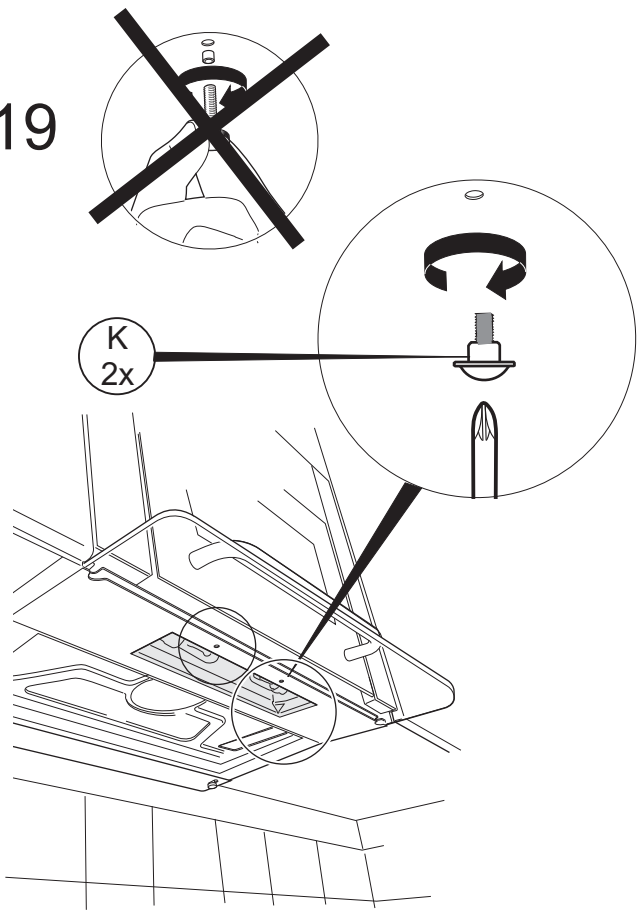

20

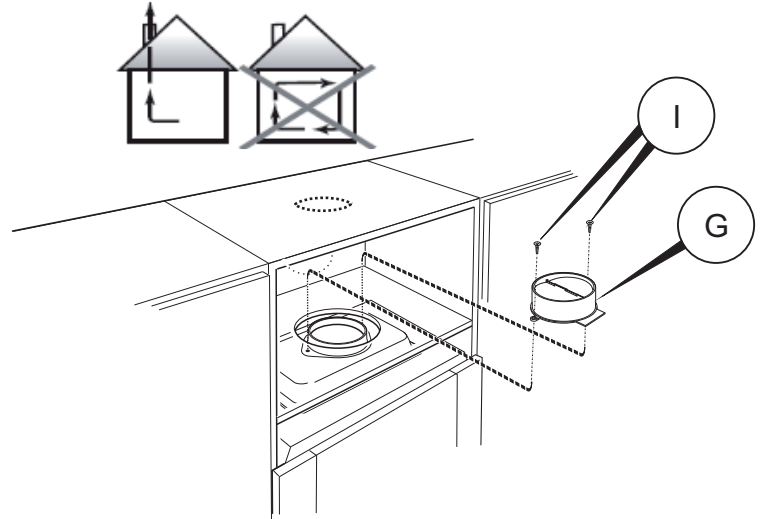

21

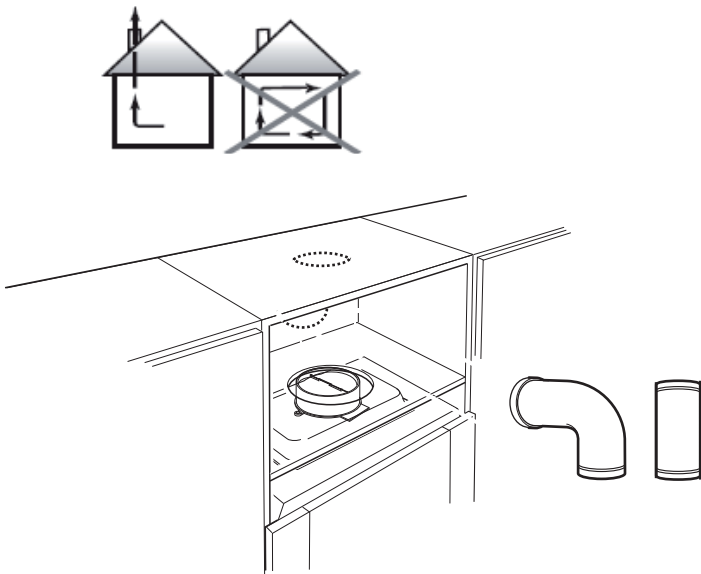

22

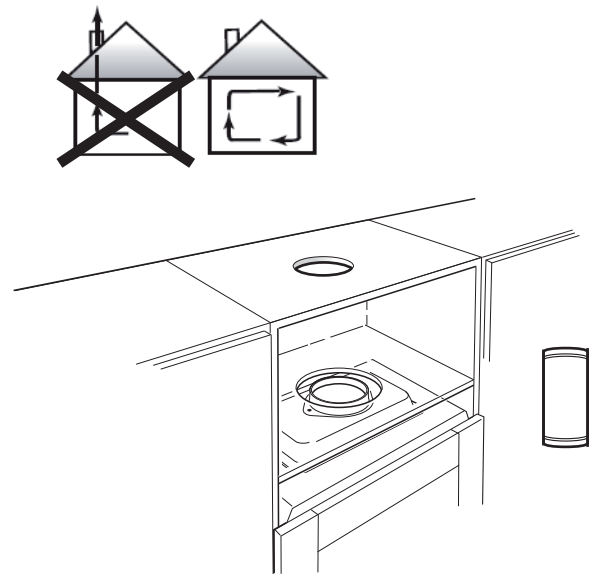

23

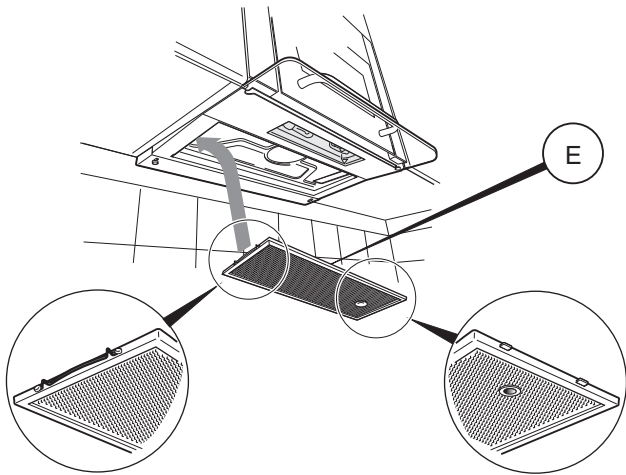
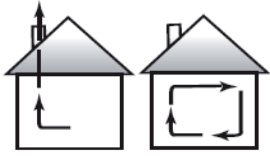

24

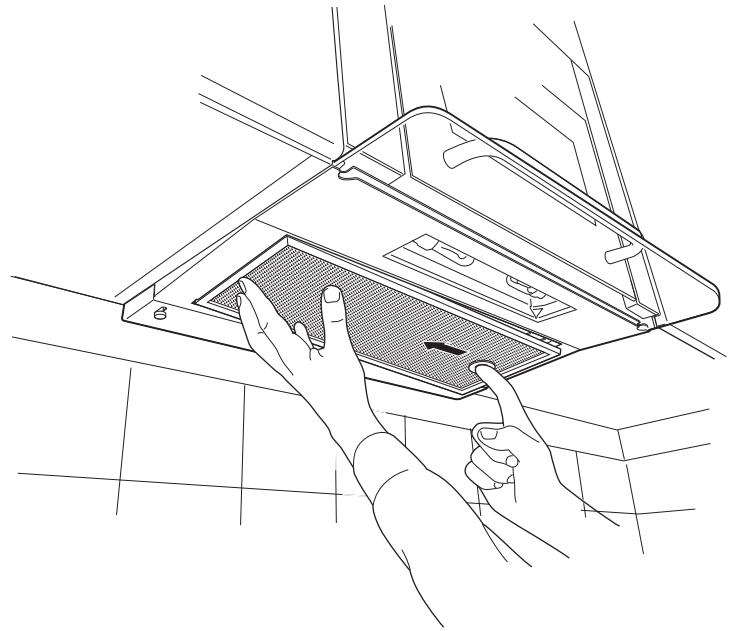

25

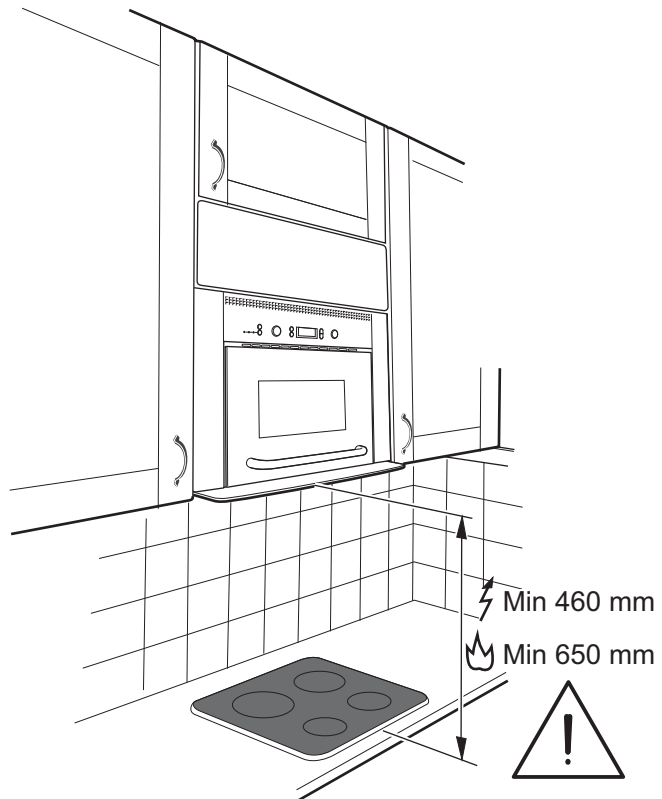



4 6 1 9 - 6 9 4 - 6 5 9 1 3