

ADG 522 IX

12NC: 851126510010

EAN code: 8003437220913

Whirlpool

SENSING THE DIFFERENCE

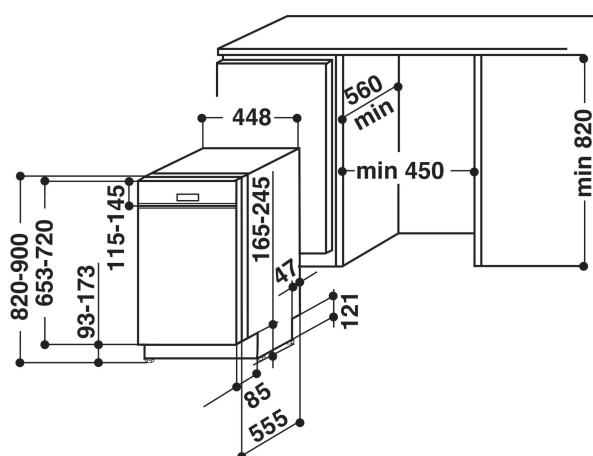

MAIN FEATURES

Construction type	Vstavaná
Installation type	Vstavaná s panelom
Type of control	Electronic
Type of control setting and signalling devices	-
Removable work top	N/A
Door decor panel	N/A
Main colour of product	Nerez
Connection rating (W)	1900
Current (A)	10
Voltage (V)	220-240
Frequency (Hz)	50
Length of Electrical Supply Cord (cm)	130
Plug type	Schuko
Length inlet hose (cm)	155
Length outlet hose (cm)	150
Adjustable plinth	Nie
Height of removable worktop (mm)	0
Adjustable feet	Yes - all from front
Height of the product	820
Width of the product	445
Depth of the product	570
Depth with open door 90 degree (mm)	-
Minimum niche height	820
Maximum niche height	900
Minimum niche width	450
Maximum niche width	600
Niche depth	560
Net weight (kg)	30.50
Gross weight (kg)	32.50

TECHNICAL FEATURES

Automatic programmes	Áno
Maximum temperature for water intake (°C)	60
Start delay options	Continuous
Start delay time max. (h)	24
Progress indicator	-
change to:	Áno
Salt light indicator	Áno
Rinse aid light indicator	Áno
Safety device	Áno
Adjustable upper basket	Áno
Largest loadable dish upper basket (cm)	0
Largest loadable dish lower basket (cm)	0

ENERGETICKÝ ŠTÍTK

Energy efficiency class - NEW (2010/30/EC)	A++
Energy consumption annual (kWh/annum) - NEW (2010/30/EC)	211
Duration of the left-on mode - NEW (2010/30/EC)	12
Power consumption in left-on mode - NEW (2010/30/EC)	5
Power consumption in off-mode - NEW (2010/30/EC)	0.50
Water consumption annual (l/annum) - NEW (2010/30/EC)	2520
Noise level (dB(A) re 1 pW)	43