

Hotpoint

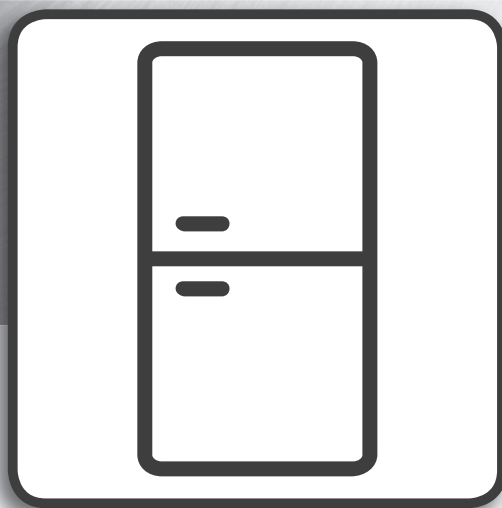

User Manual



www.hotpoint.eu/register



USER MANUAL



THANK YOU FOR BUYING A HOTPOINT PRODUCT.

In order to receive a more complete assistance, please register your appliance on www.hotpoint.eu/register

INDEX

Use & Care guide	2
Product description	2
Accessories *	2
Control panel and temperature setting	3
LED light	3
Humidity control *	3
Active oxygen *	4
ECO function*	4
Easy access tray in freezer *	4
Shelves	4
Pull Out Shelf *	4
Tuck shelf *	4
Door	4
No-frost refrigerator compartment	4
Fresh Box 0°	5
No-frost freezer compartment	5
How to use the appliance	6
First time use	6
Refrigerator compartment and food storage	6
How to store fresh food and beverages	6
Freezer compartment food storage	7
Removing the freezer drawer container	7
Tips for freezing and storing fresh food	7
Frozen food: shopping tips	7
Storage times of frozen foods	8
Functional sounds	8
Alarm table	9
Recommendation in case of no use of the appliance	9
Cleaning and maintenance	10
Troubleshooting	11
After-sales service	12
Installation guide	13

Product description

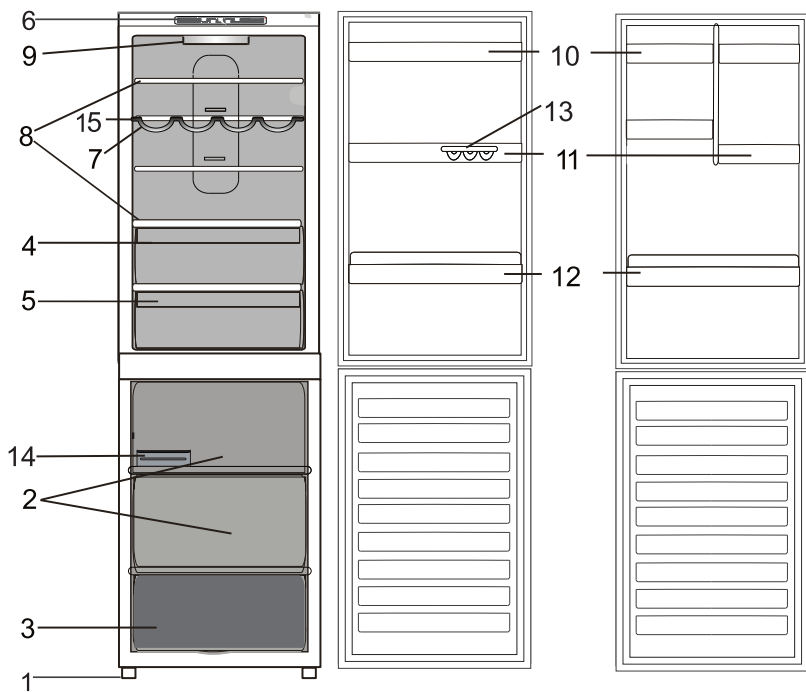

Refrigerator Compartment

- | | |
|--|---|
| <ul style="list-style-type: none"> 1. Levelling feet 2. Storage compartment 3. Freezer and storage compartment 4. Fruit and vegetable crisper 5. Cooler compartment 6. Control panel 7. Wine rack * 8. Shelves | <ul style="list-style-type: none"> 9. Lamp 10. Extractable storage shelf with cover * 11. Removable multipurpose shelves 12. Bottle shelf 13. Egg tray 14. Ice tray * 15. Tuck shelf * |
|--|---|

* Varies by number and/or position, available only on certain models.

Accessories *

EGG TRAY

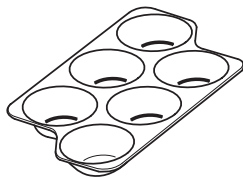

HUMIDITY CONTROL

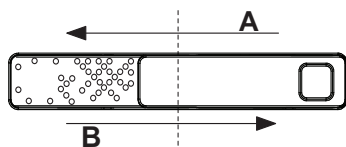

BOTTLE RACK

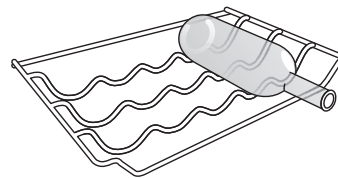

ICE TRAY

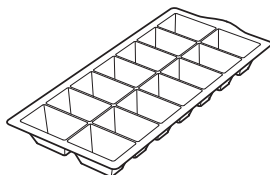

TUCK SHELF



* Available only on certain models

Control panel and temperature setting

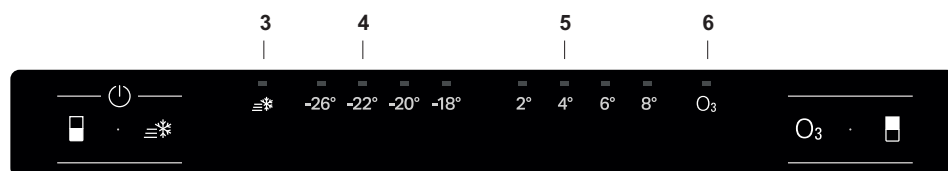

- | | |
|--|---------------------------------------|
| 1. Freezer operation button | 5. Fridge temperature indicator light |
| 2. Super freeze button | 6. Active oxygen indicator light |
| 3. Super freeze indicator light | 7. Active oxygen button |
| 4. Freezer temperature indicator light | 8. Refrigerator operation button |

On/off

To switch on/switch off the product press both Freezer Operation Button and Super Freeze Button by 3 seconds.

Freezer temperature setting

To regulate the temperature in the freezer compartment use Freezer Operation Button. The temperature of the Freezer is consisted with 4 levels as indicated on serigraphy (signaled by yellow led light).

Super Freeze Function

Use Super Freeze Button (rapid freezing) to freeze fresh food. Press button for 3 seconds to switch on the product while it is switched off. Super Freeze blue light illuminates when Super Freeze button is pressed. The Super Freeze function is the ideal solution to quickly freeze freshly cooked food as well as food that you want to store in the freezer.

Fridge temperature setting

The temperature of the Fridge is consisted with 4 levels as indicated on serigraphy (signaled by yellow led light). To regulate the temperature of the refrigerator compartment use Refrigerator Operation button.

Active oxygen function

Activate or deactivate Active Oxygen function, when the Active Oxygen button is pushed. The blue light of the Active Oxygen lights up. This device releases ozone molecules inside the refrigerator; ozone is a natural substance which combats bacteria and microorganisms, reducing their proliferation while limiting unpleasant odors. Press and hold down the ACTIVE OXYGEN and REFRIGERATOR OPERATION buttons simultaneously for at least 6 seconds to enable ECO function. To exit ECO function, you must turn off product by ON/OFF button.

LED light

If the LED light system does not work, please contact the Service to replace it.

Important: The refrigerator compartment light switches on when the refrigerator door is opened. If the door is kept open for more than 8 minutes the light will be automatically switched off.

Humidity control *

Open the humidity regulator (position B) if you want to store food in a less humid environment like fruit, or close it (position A) to store food in a more humid environment like vegetable.

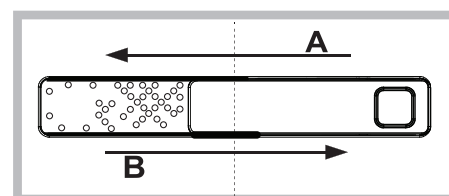

* Available only on certain models

Active oxygen *

This device releases ozone molecules inside the refrigerator; ozone is a natural substance which combats bacteria and microorganisms, reducing their proliferation while limiting unpleasant odors.

Automatically defines the amount of ozone required for prolonging the freshness of foodstuffs, eliminating odors and preventing bacteria build-up. There may be a slight distinctive odor inside the refrigerator.

The very same smell can sometimes be detected during a storm, due to the ozone produced as the charge in the lightning bolts is released; this is completely normal.

The amount produced by the device is very small and abates quickly as the antibacterial action takes place.

Device is activated pressing the dedicated key on the display located in front of the fridge door. By holding the Active Oxygen button and Refrigerator Operation button for an least 6 s you can enable ECO feature.

ECO function*

The ECO function can be enabled to optimize energy consumption.

Press and hold down the ACTIVE OXYGEN and REFRIGERATOR OPERATION buttons simultaneously for at least 6 seconds to enable this function. On enabling the function, 4 indicator lights will go on for 2 seconds: ACTIVE OXYGEN light, SUPER FREEZE light and two temperature lights - one for the refrigerator and one for the freezer.

After 5 seconds the interface will enter the energy saving mode and the indicator lights will go off. The interface stays off even when the door is opened. Just press any button to switch it on again. Press the adjustment buttons to change the temperature. Consumption will be optimized 48h after the function was enabled.

To disable the ECO function, switch off the product (see description). The product can be switched on again for normal operation.

In humid environments, when the ECO function is enabled, slight condensation may form on the doors; normal operating conditions are restored when the function is disabled.

Easy access tray in freezer *

Freezer tray is useful to easily access frequently used products, freeze or simply store leftovers or small items.

Shelves

All shelves, flaps and pull-out baskets are removable.

Pull Out Shelf *

Due to the special guides the shelves are removable and the height is adjustable allowing easy storage of large containers and food. Height can be adjusted without complete removal of the shelf.

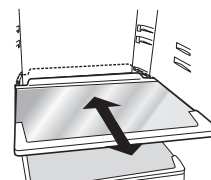

Tuck shelf *

Thanks to the rail system, this shelf allows you to slide under the front part, creating an extra space for storing tall bottles or pitchers.

Door

Door reversibility

Note: the direction of door opening can be changed. If this operation is performed by After-sales Service it is not covered by the warranty. Is recommended to reverse door swing by two persons. Follow instruction.

No-frost refrigerator compartment

Refrigerator compartment defrosting is completely automatic.

Droplets of water on the rear wall inside the refrigerator compartment indicate that the automatic defrost phase is in progress.

The No Frost system circulates cold air continuously to collect humidity and prevent ice and frost formation.

The system maintains an optimal humidity level in the compartment, preserving the original quality of the food, preventing the food from sticking together and making defrosting a thing of the past.

Do not block the aeration cells by placing food or containers in direct contact with the refrigerating back panel.

Close bottles and wrap food tightly.

* Available only on certain models

Fresh Box 0°

The Fresh Box 0° compartment guarantees a temperatures operating range from -2°C to 3°C depending on chosen fridge temperature setting which is ideal to:

- store meat, fish and delicate food;
- rapid cooling of hot foods;
- low temperature defrosting (it inhibits the proliferation of microorganisms)

You can get the 0°C temperature, in standard conditions, when the fridge compartment temperature is set for minimum temperature. Remember that by changing the fridge temperature you change the Fresh Zone 0° compartment temperature as well. Keep in mind that Fresh Box 0° compartment is a mechanical feature operating all the time, it cannot be switched off.

No-frost freezer compartment

No Frost freezers provide chilled air circulation around the storage areas, and prevent the formation of ice, thereby completely eliminating the need for defrosting.

Frozen items don't stick to the walls, labeling stays legible and storage space remains neat and clear.

How to use the appliance

First time use

Before connecting the appliance, clean the compartments and accessories well with lukewarm water and bicarbonate.

After plugging the appliance to the mains, it starts the operation automatically.

After starting the appliance, wait at least 4-6 hours before placing food into the appliance.

When the appliance is connected to the power supply, the display lights up and all the icons appear on the display for approximately 1 second. The default (factory) values of the fridge compartment settings light-up.

Refrigerator compartment and food storage

The refrigerator compartment allows for the storage of fresh food and drink. The refrigerator compartment defrosts completely automatically. The occasional presence of drops of water on the internal back wall of the compartment is a sign of the automatic defrosting phase. The defrosting water is channelled into a drain and then collected in a container, where it evaporates.

Note: the ambient temperature, how often the doors are opened and the position of the appliance may affect the internal temperatures in the two compartments. Set the temperatures depending on these factors. In very humid conditions, condensation may form in the refrigerator compartment, especially on the glass shelves. In this case, it is recommended that you close containers with liquids in (e.g. a pot of stock), wrap up food with a high water content (e.g. vegetables) and turn on the fan, if there is one. All of the drawers, door shelves and shelves can be removed.

Air ventilation

The natural circulation of air in the refrigerator compartment results in zones with different temperatures. It is coldest directly above the fruits and vegetables crisper and at the rear wall. It is warmest at the top front of the compartment. Insufficient ventilation results in an increase in energy consumption and reduction of the refrigerating performance.

How to store fresh food and beverages

Foods which give off a large amount ethylene gas (apples, apricots, pears, peaches, avocado, figs, prunes, blueberries, mellons, beans) and those that are sensitive to this gas, such as fruit vegetables and salad, should always be separated or wrapped so as not to reduce the storage life; for example do not store tomatoes together with kiwi fruits or cabbage. Do not store food too close together to enable sufficient air circulation. Use recyclable plastic, metal, aluminum and glass containers and cling film to wrap foods. If you have a little quantity of food to store in the refrigerator, we recommend to use the shelves above the crisper for fruits and vegetables since this is the coolest area of the compartment. Always use closed containers for liquids and for food that may give off or be tainted by odor or flavor transfer or cover them. To avoid bottles falling over, you can use the bottle holder (available on selected models).

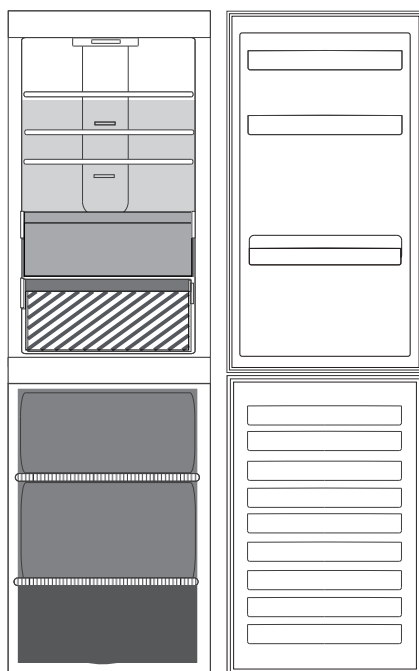

Legend



TEMPERATE ZONE

Suggested for storage of tropical fruit, cans, drinks, eggs, sauces, pickles, butter, jam

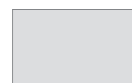

COOL ZONE

Suggested for the storage of cheese, milk, daily food, delicatessen, yogurt



FRUIT AND VEGETABLE DRAWER



COOLEST AREA

Suggested for storage of cold cuts, desserts, meat and fish

Freezer compartment food storage

The freezer compartment allows for the storage of frozen food (for the period indicated on the packaging) and the freezing of fresh food. The quantity of fresh food that can be frozen in 24 hours is written on the rating plate. Arrange the fresh food in the freezing area inside the freezer compartment, leaving enough space around the food packages to allow air to circulate freely. It is advisable that you do not re-freeze food that has partially defrosted. It is important to wrap the food in a way that prevents the ingress of water, humidity or condensation.

To get more volume, the freezer compartment can be used without the freezer drawers. Make sure that the door is closed properly.

Ice cubes

Fill 2/3 of the ice tray with water and put it back in the freezer compartment. Do not use sharp or pointed objects to remove the ice under any circumstances.

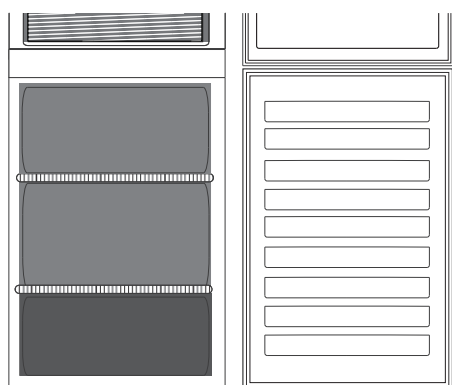

Legend



FREEZER DRAWERS



FREEZING ZONE DRAWER

(Max cool zone)

Suggested to freeze fresh / cooked food.

Removing the freezer drawer container

- Open the freezer door.
- Pull the upper container upwards by the right and left corners (1).
- Remove the drawer (2).
- Install the upper container in the reverse order.

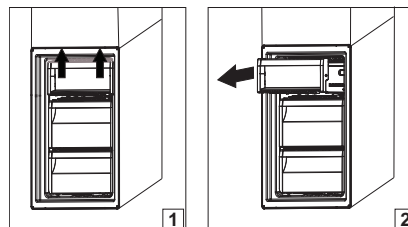

Tips for freezing and storing fresh food

- We recommend to label and date all your frozen food. Adding a label will help you to identify foods and to know when they should be used before their quality deteriorates. Do not re-freeze defrosted food.
- Before freezing, wrap and seal fresh food in: aluminium foil, cling film, air and water-tight plastic bags, polythene containers with lids or freezer containers suitable for freezing fresh food.
- Food must be fresh, mature and of prime quality in order to obtain high quality frozen food.
- Fresh vegetables and fruit should preferably be frozen as soon as they are picked to maintain the full original nutritional value, consistency, colour and flavor. Some meat, especially game, should be hung before it is frozen.
- Always leave hot food to cool before placing in the freezer.
- Eat fully or partially defrosted foods immediately. Do not refreeze unless the food is cooked after it has thawed. Once cooked, the thawed food can be refrozen.
- Do not freeze bottles with liquid.

Frozen food: shopping tips

When purchasing frozen food products:

- Ensure that the packaging is not damaged (frozen food in damaged packaging may have deteriorated). If the package is swollen or has damp patches, it may not have been stored under optimal conditions and defrosting may have already begun.
- When shopping, buy frozen foods at the end of your trip and transport them in a thermally insulated cool bag.
- Once at home, place the frozen foods immediately in the freezer.
- If food has defrosted even partially, do not refreeze it. Consume within 24 hours.
- Avoid or reduce temperature variations to the minimum. Respect the best-before date on the package.
- Always observe the storage information on the package.

Storage times of frozen foods

Product	Storage period
Butter or margarine	6 months
Cheese	3 months
Fish	2/3 months
Shellfish	1 month
Fruits (except citrus)	8-12 months
Ice cream or sherbet	2/3 months
Meat	
Ham- sausage	2 months
Roasts (beef-pork- lamb)	8/12 months
Steaks or chops (beef-lamb-pork)	4 months
Milk, fresh fluid	1-3 months
Poultry (chicken-turkey)	5-7 months
Vegetables	8-12 months

Functional sounds

Sounds coming from your appliances are normal since it has a number of fans and engines to regulate performances that switch on and off automatically.

Some of the functional sounds can be reduced through:

- Leveling the appliance and installing it on an even surface.
- Separating and avoiding contact between the appliance and furniture.
- Checking if the internal components are correctly placed.
- Checking if bottles and containers are not in contact with each other.

Some of the functional sounds you might hear

1. A hissing sound when switching on the appliance for the first time or after a long pause.
2. A gurgling sound when refrigerant fluid enters into the pipes.
3. BRRR sound is from the compressor running.
4. Buzzing sound when water valve or fan start working.
5. A cracking sound when compressor starts.
6. The CLICK is from the thermostat which adjusts how often the compressor is running.

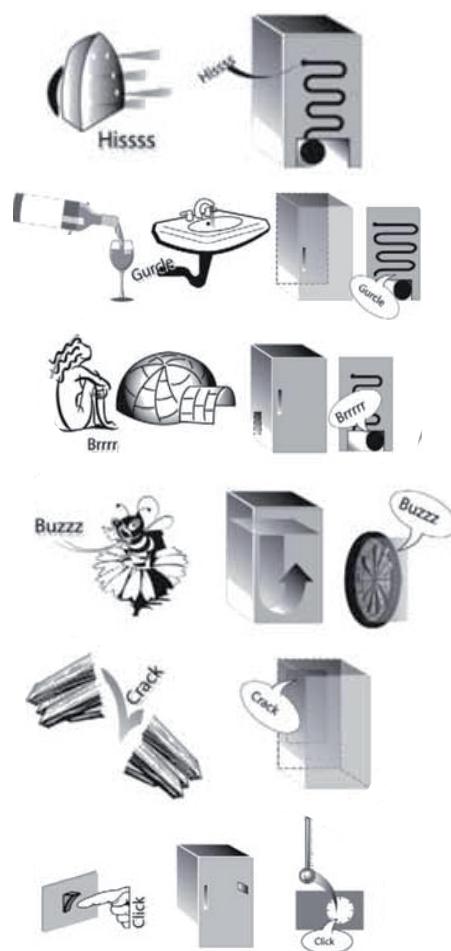

Alarm table

ALARM TYPE	SIGNAL	CAUSE	CURE
Door open alarm.	The alarm sounds and the light blinks.	The door has remained open for more than 3 minutes.	Close the door.
Temperature alarm.	The alarm sounds and the two blue indicator lights flash.	The temperature in the freezer is too high. Check the quality of the food products and dispose if necessary.	To turn off the acoustic signal, open and close the refrigeration door and restore normal operation product.
	The temperature in the freezer has reached a dangerous level. The food must be disposed immediately.	To turn off the acoustic signal, open and close the refrigeration door and restore normal operation product.	To turn off the acoustic signal, open and close the refrigeration door and restore normal operation product.

Recommendation in case of no use of the appliance

In the event of non-use of the appliance

Disconnect the appliance from the power supply, empty it, defrost it (if necessary) and clean it.

Keep the doors slightly ajar to let air circulate inside the compartments. By doing this, you avoid the development of mould and bad odours.

In the event of an interruption to the power supply

Keep the doors closed so the food stays cold for as long as possible. Do not re-freeze food that has partially defrosted. If there is a prolonged power cut, the black out alarm may also activate (in products with electronics).

Cleaning and maintenance

Before any cleaning or maintenance operation, unplug the appliance from the mains or disconnect the electrical power supply.

Never use abrasives. Never clean refrigerator parts with flammable fluids.

Do not use steam cleaners.

The buttons and control panel display must not be cleaned with alcohol or alcohol-derived substances, but with a dry cloth.

- ▶ Periodically clean the appliance with a cloth and a solution of lukewarm water and neutral detergent specifically for refrigerator interiors.
- ▶ The removable accessories may be soaked in warm water and soap or dishwashing liquid. Rinse and dry them carefully.
- ▶ Clean the outside of the appliance and the door seal with a damp cloth and dry with a soft cloth.
- ▶ Condenser placed in the rear of the appliance should be cleaned regularly using a vacuum cleaner.
- ▶ Unless otherwise specified the appliance accessories are not dishwasher safe.

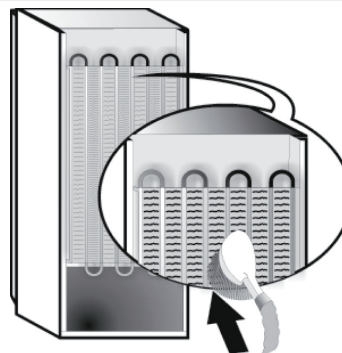

Important:

- ▶ The buttons and control panel display must not be cleaned with alcohol or alcohol-derived substances, but with a dry cloth.
- ▶ The refrigeration system pipes are located near the defrost pan and can become hot. Periodically clean them with a vacuum cleaner.

To ensure continuous and correct flow of defrost water, regularly clean the inside of the draining hole on the back of the refrigerator near the fruit and vegetable drawer, using the tool provided*.

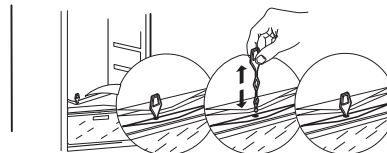

Troubleshooting

What to do if...	Possible reasons	Solutions
The appliance is not working.	There may be an appliance power supply problem.	<ul style="list-style-type: none"> • Check if power cable plugged into a live socket with the proper voltage. • Check if the protection devices and fuses of the electrical system in your home
There is water in the defrost pan.	This is normal in hot, damp weather. The pan can even be half full.	<ul style="list-style-type: none"> • Make sure the appliance is level so that the water does not overflow.
The edges of the appliance cabinet, which come in contact with the door seal, are warm to the touch.	This is not a defect. This is normal in hot weather and when the compressor is running.	
The light does not work.	The light may need replacing. The appliance may be in On/ Stand-by model.	<ul style="list-style-type: none"> • Make sure if the protection devices and fuses of the electrical system in your home work well. • Check if the power cable is plugged into a live socket with the proper voltage • In case the LEDs are broken the user must call the Service for exchange of the same type available only at our Aftersales Service Centers or authorized dealers.
The motor seems to run too much.	Motor running time depends on different things: number of door openings, amount of food stored, temperature of the room, setting of the temperature controls.	<ul style="list-style-type: none"> • Make sure that the appliance controls are correctly set. • Check if there is not a large amount of food been added to the appliance. • Check that the door is not opened too often. • Check that the door close properly.
The appliance temperature is too high.	There could be various causes (see "Solutions").	<ul style="list-style-type: none"> • Make sure that the condenser (back the appliance) is free of dust and fluff. • Make sure that the door properly closed. • Make sure that the door seals properly fitted. • On hot days or if the room is warm, the motor naturally runs longer. • If the appliance door has been left open for a while or if large amounts of food have been stored, the motor will run longer in order to cool down the interior of the appliance.
The doors do not open and close properly.	There could be various causes (see "Solutions").	<ul style="list-style-type: none"> • Check that food packages are not blocking the door. • Check that the internal parts or automatic ice maker are not out of position. • Check that the door seals are not dirty or sticky. • Ensure the appliance is level.

After-sales service

BEFORE CALLING THE AFTER-SALES SERVICE

1. See if you can solve the problem by yourself with the help of the suggestions given in the **TROUBLESHOOTING**.
2. Switch the appliance off and back on again to see if the fault persists.

IF AFTER THE ABOVE CHECKS THE FAULT STILL OCCURS, GET IN TOUCH WITH THE NEAREST AFTER-SALES SERVICE

To receive assistance, call the number shown on the warranty booklet or follow the instructions on the website

www.hotpoint.eu

When contacting our Client After sales service, always specify:

- a brief description of the fault;
- the type and exact model of the appliance;
- the service number (number after the word Service on the rating plate). The service number is also indicated on the guarantee booklet;
- your full address;
- your telephone number.

If any repairs are required, please contact an authorised aftersales service (to guarantee that original spare parts will be used and repairs carried out correctly).

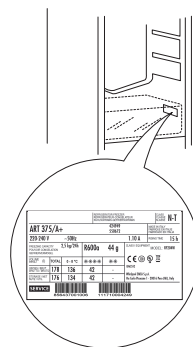

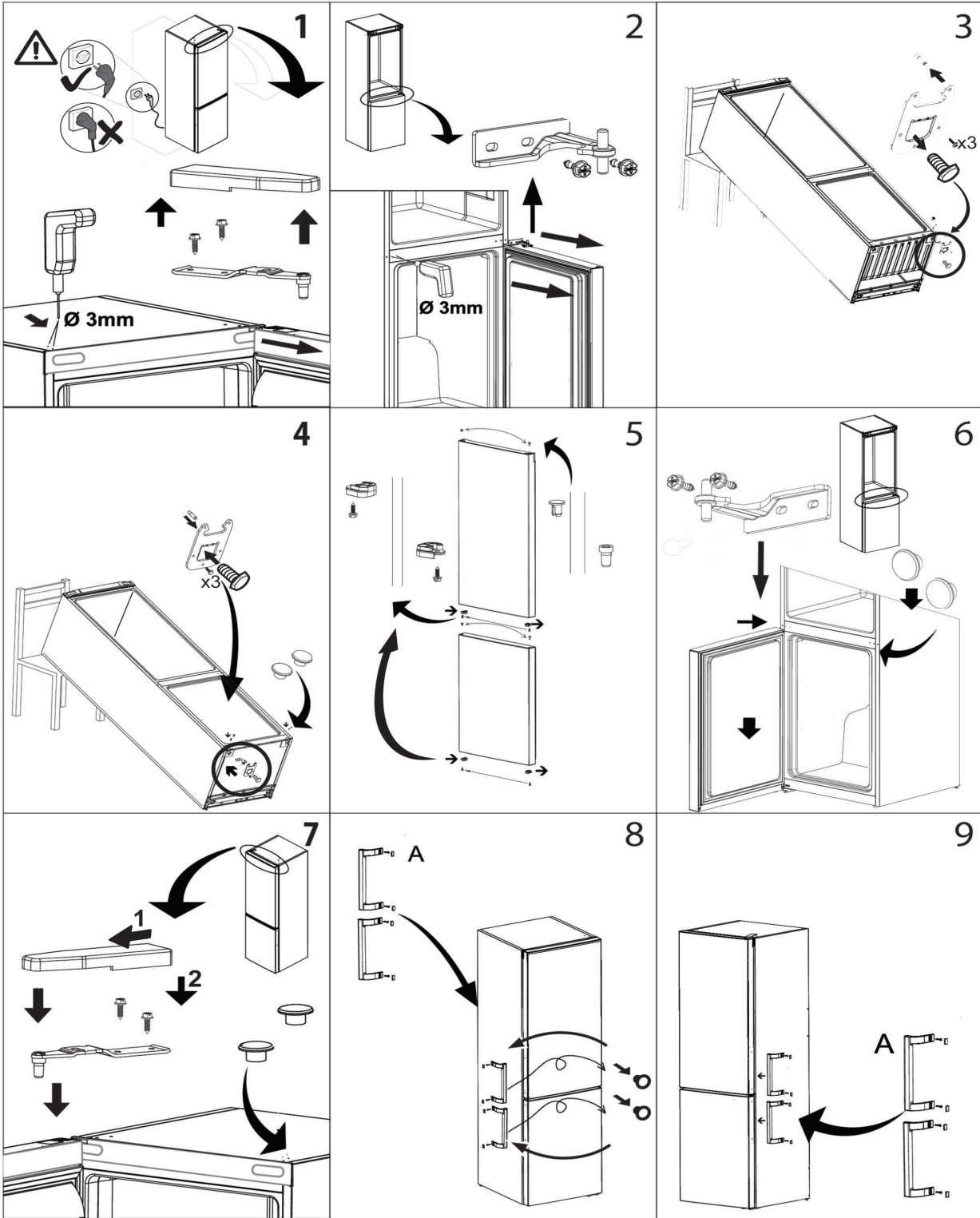

400011314274