

TUMBLE DRYER

GB

English, 1

Contents

Installation, 2

Warnings, 4

Care and maintenance, 6

Control Panel, 8

The Display, 9

Start and Programmes, 10

Laundry, 14

Troubleshooting, 15

Service, 16

www.hotpoint.eu



This symbol reminds you to read this instruction manual.

! Keep this instruction booklet on hand in order to refer to it when necessary. Take it with you when you move, and, should you sell this appliance or pass it on to another party, make sure that this booklet is supplied along with the dryer so that the new owner may be informed about warnings and suggestions on how the dryer works.

! Read these instructions carefully; the following pages contain important information on installation and suggestions on how the appliance works

Installation

GB

Where to install the tumble dryer

If the dryer is installed below a worktop, ensure there are 10 mm between the upper panel of the dryer and any objects above it, and 15 mm between the sides of the machine and the walls or furniture units adjacent to it. This ensures adequate air circulation.

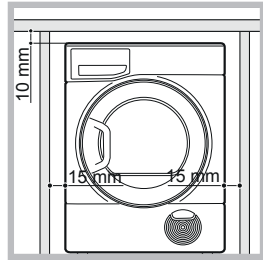

The appliance must be installed with the rear surface placed against a wall.

Ventilation

Make sure that the dryer is installed in a room free of humidity and with adequate air circulation. The flow of air around the dryer is essential to allow water to condense during drying; the dryer will not function properly if it is placed in an enclosed space or inside a cabinet.

Some condensation may form if the dryer is used in a small or cold room.

Water drain

If your dryer is installed next to a drain the water can be plumbed into this drain. This does away with the need to empty the water container. If the dryer is stacked onto or installed next to a washing machine it can share the same drain. The height of the drain must be less than 3' (1 m) from the bottom of the dryer.

Remove existing hose from position shown in picture A and fit a suitable length of hose and connect as shown in picture B.

The drain tube has to be below 1 m from the bottom of the Dryer

Make sure that the hose is not squashed or kinked when the dryer is in its final location.

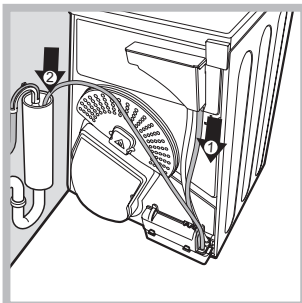

Picture A

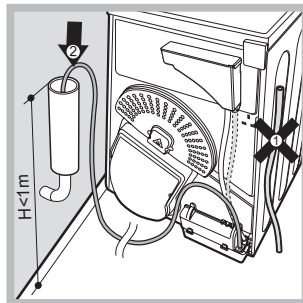

Picture B

⚠ We do not recommend that the dryer is installed in a cupboard but the dryer must never be installed behind a lockable door, a sliding door or a door with a hinge on the opposite side to that of the dryer door.

Electrical connections

Before plugging the appliance into the socket, check the following:

⚠ Make sure your hands are dry.

⚠ The socket must have an earth connection.

⚠ The socket must be able to withstand the machine's maximum power output as indicated on the rating plate.

⚠ The power supply voltage must fall within the values indicated on the data plate.

⚠ Do not use extension leads. Do not pull the power supply cable. Do not use multiple plug adaptors if the appliance is fitted with a plug. For appliances with fitted plug, if the plug is not suitable for your socket outlet, contact a qualified technician.

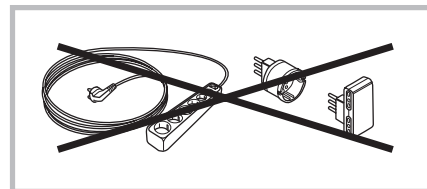

⚠ The dryer must not be installed outdoors, even if the space is sheltered.

⚠ Once installed, the dryer's electrical wire and plug must be within reach.

⚠ The power cord must not be bent or squashed.

⚠ If the plug being replaced is a non-rewirable type, then the cut-off plug must be disposed of safely. DO NOT leave it where it can be inserted into a socket and create a shock hazard.

⚠ The power must be regularly checked. If the supply cord is damaged, it must be replaced by service agent. (see Assistance).



⚠ The manufacturer denies any responsibility should any of these rules not be followed.

⚠ If in doubt about any of the above consult a qualified electrician.

Preliminary information

Once the tumble dryer is installed, clean the inside of the drum before operating it and remove any dirt accumulated during transportation.

Maximum load: 8 kg

Power consumption			
off-mode (Po) - Watts			0.17
left-on mode (Pl) - Watts			0.17
Programs	Kg	kWh	Minutes
Standard cotton* 	8	4.72	155
Standard cotton 	4	2.57	86
Synthetics	3	1.27	55
* This is the reference program for the energy label and suitable to dry normal wet cotton laundry. This is the most efficient programme in terms of energy consumption for drying wet cotton laundry.			

Warnings

GB

! This appliance has been designed and built according to international safety standards. These warnings are given for safety reasons and must be followed carefully.

General safety

- This appliance can be used by children aged from 8 years and above and persons with reduced physical, sensory or mental capabilities or lack of experience and knowledge if they have been given supervision or instruction concerning use of the appliance in a safe way and understand the hazards involved.
- This tumble dryer has been designed for home, and not professional, use.
- Do not touch the appliance while barefoot or with wet hands or feet.
- Unplug the machine by pulling on the plug, not the cord.
- After using the dryer, turn it off and unplug it. Keep the door closed to make sure that children do not use it as a toy.
- Children should be supervised to ensure that they do not play with the dryer.
- Cleaning and user maintenance shall not be made by children without supervision.
- Children of less than 3 years should be kept away from the appliance unless continuously supervised.
- The appliance must be installed correctly and have proper ventilation. The air intake at the front of the dryer should never be obstructed (see *Installation*).
- Never use the dryer on carpeting where the pile height would prevent air from entering the dryer from the base.
- Check to see if the dryer is empty before loading it.
-  The back of the dryer could become very hot. Never touch it while in use.
- Do not use the dryer unless the filter, water container and condenser are securely in place (see *Maintenance*).
- Do not overload the dryer (see *Laundry* for maximum loads).
- Do not load items that are dripping wet.
- Carefully check all instructions on clothing labels (see *Laundry*).
- Do not tumble dry large, very bulky items.
- Do not tumble dry acrylic fibres at high temperatures.
- Do not turn off the dryer when there are still warm items inside.
- Clean the filter after each use (see *Maintenance*).
- Empty the water container after each use (see *Maintenance*).
- Clean the condenser unit at regular intervals (see *Maintenance*).
- Do not allow lint to collect around the dryer.
- Never climb on top of the dryer. It could result in damage.
- Always follow electrical standards and requirements (see *Installation*).
- Always buy original spare parts and accessories (see *Service*).

To minimise the risk of fire in your tumble dryer, the following should be observed:

- Tumble dry items only if they have been washed with detergent and water, rinsed and been through the spin cycle. It is a fire hazard to dry items that HAVE NOT been washed with water.
- Do not dry garments that have been treated with chemical products.
- Do not tumble dry items that have been spotted or soaked with vegetable or cooking oils, this constitutes a fire hazard. Oil-affected items can ignite spontaneously, especially when exposed to heat sources such as a tumble dryer. The items become warm, causing an oxidation reaction with the oil. Oxidation creates heat. If the heat cannot escape, items can become hot enough to catch fire. Piling, stacking or storing oil-affected items can prevent heat from escaping and so create a fire hazard. If it is unavoidable that fabrics containing vegetable or cooking oil or those that have been contaminated with hair care products be placed in a tumble dryer they should first be washed with extra detergent - this will reduce, but not eliminate the hazard. They should not be removed from the dryer and piled or stacked while hot.
- Do not tumble dry items that have previously been cleaned in or washed in, soaked in or soiled with petrol/ gasoline, dry cleaning solvents or other

flammable or explosive substances. Highly flammable substances commonly used in domestic environments including cooking oil, acetone, denatured alcohol, kerosene, spot removers, turpentine, waxes and wax removers. Ensure these items have been washed in hot water with an extra amount of detergent before being dried in the tumble dryer.

- Do not tumble dry items containing foam rubber (also known as latex foam), or similarly textured rubber like materials. Foam rubber materials can, when heated, produce fire by spontaneous combustion.
- Fabric softener or similar products should not be used in a tumble dryer to eliminate the effects of static electricity unless the practice is specifically recommended by the manufacturer of the fabric softener product.
- Do not tumble dry undergarments that contain metal reinforcements eg. bras with metal reinforcing wires. Damage to the tumble dryer can result if the metal reinforcements come loose during drying.
- Do not tumble dry rubber, plastic articles such as shower caps or babies waterproof covers, polythene or paper.
- Do not tumble dry rubber backed articles, clothes fitted with foam rubber pads, pillows, galoshes and rubber coated tennis shoes.
- Remove all objects from pockets such as lighters and matches.

! WARNING: Never stop the dryer before the end of the drying cycle unless all items are quickly removed and spread out so that the heat is dissipated.

Save energy and respect the environment

- Wring out all items to eliminate excess water before tumble drying (if you use a washing machine first, select a high spin cycle). Doing this will save time and energy during drying.
- Always dry full loads - you save energy: single items or small loads take longer to dry.
- Clean the filter after each use to contain energy consumption costs (*see Maintenance*).

Care and maintenance

GB

Disconnecting the power supply

! Disconnect the dryer when not in use or during cleaning and maintenance operations.

Cleaning the filter after each cycle

The filter is a fundamental component of the dryer: its function is to collect lint and fluff that form during drying.

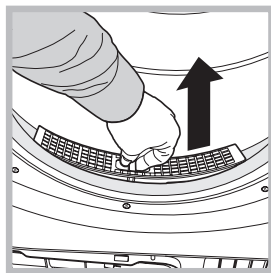

Clean the filter once drying is completed, by rinsing it under running water or cleaning it with a vacuum cleaner. Should the filter become clogged, the flow of air inside the dryer will be seriously hampered: drying times becomes longer and more energy is consumed.

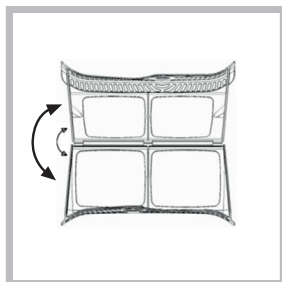

Moreover, the dryer may become damaged. The filter is located in front of the dryer seal (see *Picture*).

Removing the filter:
1. Pull the filter's plastic handle upwards (see

Picture).

2. Clean the fluff off the filter and replace it correctly. Ensure that the filter is pushed fully home.

! Do not use the dryer unless the filter has been replaced in its holder.

Checking the drum after each cycle

Rotate the drum manually to remove smaller items (handkerchiefs) that could have been left inside the dryer.

Cleaning the drum

! Avoid using abrasives, steel wool or stainless steel cleaning agents to clean the drum. A coloured film may appear on the stainless steel drum surface: it may be caused by a combination of water and/or cleaning agents such as wash-softeners. This coloured film does not affect the dryer's performance.

Emptying the water container after each cycle

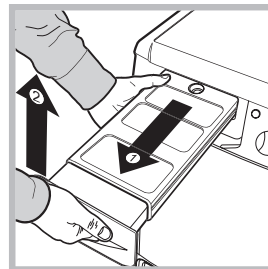

Remove the water container and empty it into a sink or other suitable drain outlet, then replace it correctly. Always check the water container and empty it before starting a new drying cycle.

-Failure to empty the water container may cause the following:

- The dryer stops heating (thus the load may still be damp at the end of the drying cycle).

Priming the Water Collection System

When your dryer is new, the Water Container will not collect Water until the system is primed, this will take 1 or 2 drying cycles. Once primed it will collect Water during every cycle.

Cleaning the condenser unit.

- Remove the condenser (see *Picture* below) unit regularly (monthly) and clean off any fluff deposits from the plates by rinsing it with cold water running on the rear end of the condenser.

Removing the condenser:

1. Disconnect the dryer from the power supply and open the door.

2. Open the condenser cover (see *Picture* below), unlock the three catches by turning them 90° anti-clockwise, then pull on the grip to remove the condenser.

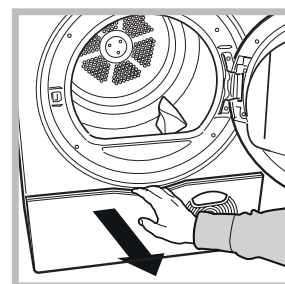

3. Clean the surface of the seals and replace the unit with the arrows pointing upwards, while making sure that the catches are securely fixed.

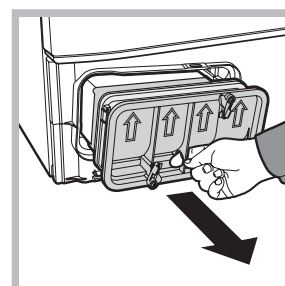

Cleaning the tumble dryer

- The external metal, plastic and rubber parts can be cleaned with a damp cloth.
- Clean the front air intake grille regularly (every 6 months) with a vacuum cleaner to remove any lint, fluff or dust deposits. Furthermore, remove any lint deposits from the front part of the condenser and from the filter area, using a vacuum cleaner every so often.

! Do not use solvents or abrasives.

! Have the dryer checked regularly by authorised technical personnel in order to ensure that the electrical and mechanical parts work safely (see Assistance).

Quick Tips

!Remember to clean your filter and Condenser unit after each load.

! Remember to empty your water container after each load.

! Doing this will keep your machine working at its BEST!

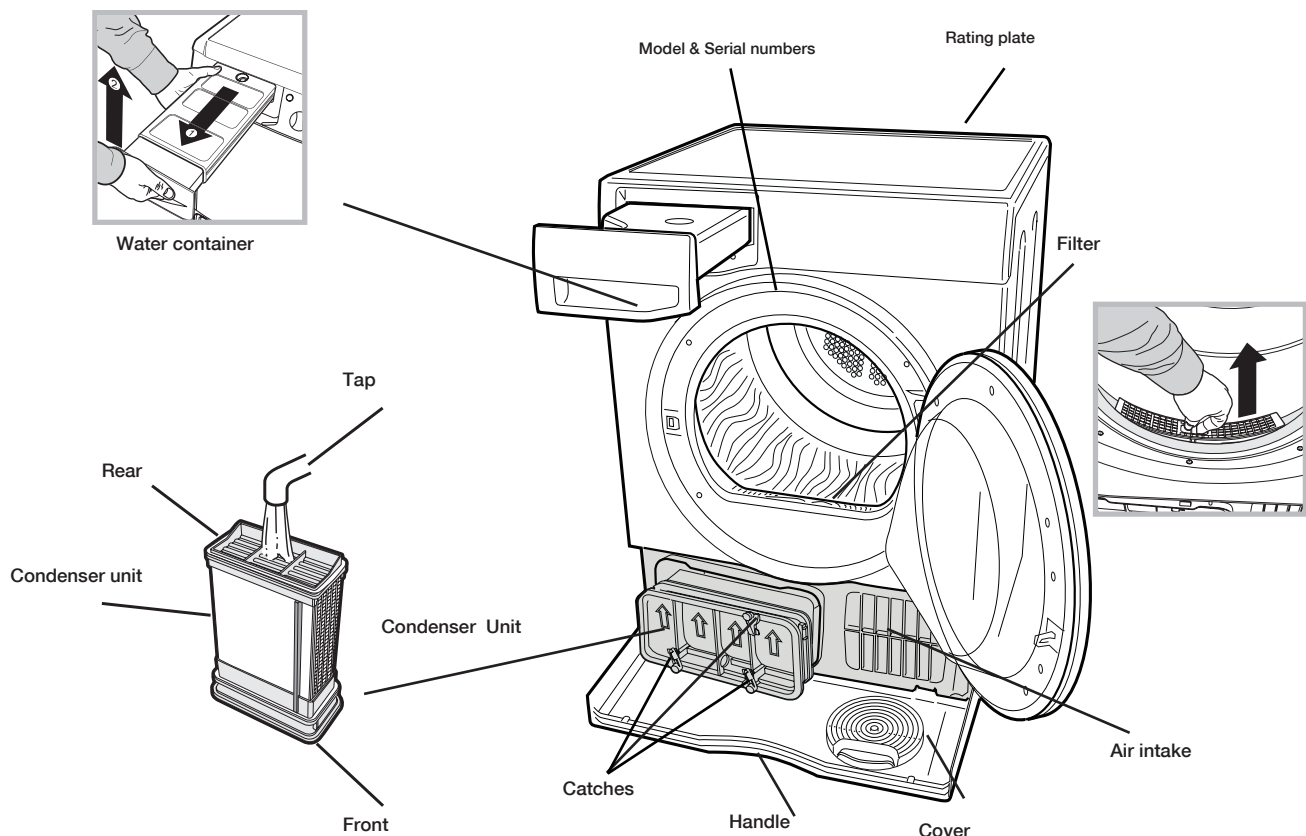

Control panel

GB

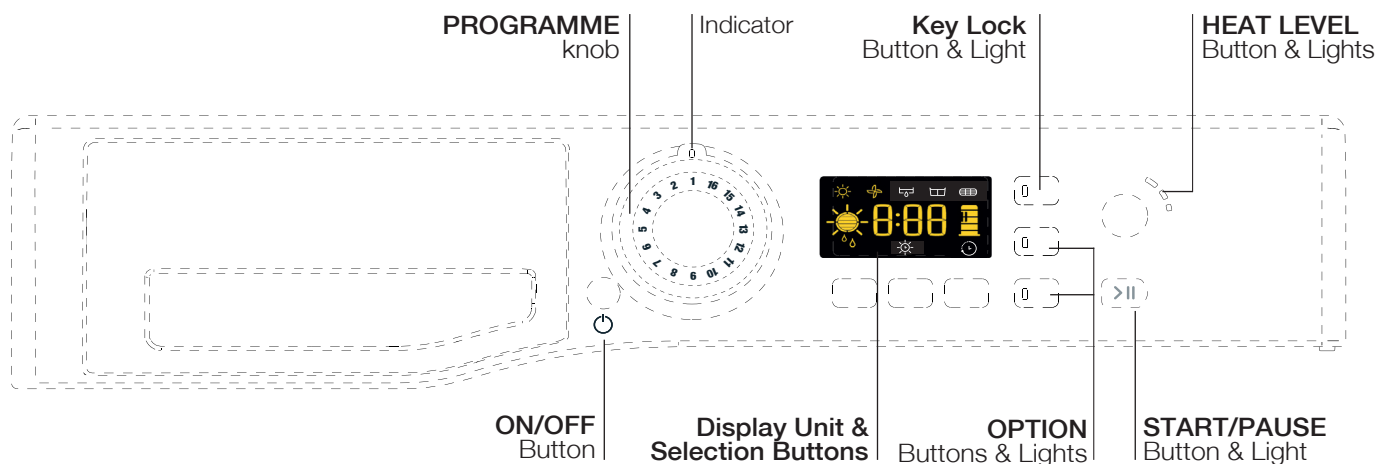

The **ON/OFF** button : If the dryer is running and this button is pressed and held for more than 3 seconds the dryer is turned off, it counts down 3, 2, 1, Off and the programme is then cancelled. Press and hold for more than 3 seconds and the dryer reactivates.

The **PROGRAMMES** knob sets the programme: rotate it until the indicator is pointing to the programme you want to select (see *Start and Programmes*).

The **OPTION** buttons select available options for your selected programme. The lights indicate that the option has been selected.

The **START/PAUSE** button/light  starts a selected programme. When you press this button there will be one beep and the progress lights will flash to confirm the action. When a programme is running, pressing this button in pauses the programme and stops the dryer. The light is green when programme is running, flashing amber if the programme has been paused or flashing green if on standby waiting to start a programme.

The **Display Unit** gives an indication of the drying or delay time together with icons that light to give warning information and show the status of your programmes progress.

The three buttons below the display select 'Automatic' or 'Timed Dry' and if required a delayed start (see *Start and Programmes* or *The Display*).

The **Key Lock** button/light : Press and hold this button after selecting your programme and any options, the light turns on. This prevents the programme settings from being changed. When the light is lit, the other buttons are disabled. Hold the button to cancel and the light will go out.

The **Empty Water** icon : signals that the water container should be emptied. The display will take a few seconds to update after replacing the empty water container, the dryer must be running for this to happen (see *The Controls*).

Note: If the water container fills the 'water container full' icon  flashes, the display shows "H2O", the heat is turned off and your clothes will not dry.

The **Clean Filter** icon : gives a reminder before every programme, that it is essential to clean the filter every time the dryer is used (see *Maintenance and Care*).

The **Clean Condenser** icon : gives a reminder that it is essential to clean the condenser at regular intervals (see *Maintenance and Care*).

The Display has three main functions, each with its corresponding button.



Dryness Sensing Levels









After selecting a programme that has a Sensor Dry option, press and release the button until the required dryness sensing level is displayed. If the sensing option is not available with your selected programme, the display will flash and the buzzer will beep three times.

! Some sensing programmes do not have all seven dryness level options available.



Dryness levels:

-  **Damp Dry:** Dries your items ready to be ironed using a machine or rotary ironer.
-  **Iron Dry:** Dries your items ready to be ironed with a hand iron.
-  **Hanger Dry Plus:** Dries your delicate items ready to be hanged for final drying.
-  **Hanger Dry:** Dries your items ready to be hanged for final drying.
-  **Light Dry:** Dries your delicate items ready to be put away.
-  **Cupboard Dry:** Dries your items ready to be put away.
-  **Extra Dry:** Dries your items ready to be worn.

Timed Dry



After selecting a programme that has a Timed Dry option, press the Timed Dry button and the Timed Dry icon  will light, the display will reduce the selected time each time you press and release this button (see Start and Programmes). Each programme that has a timed option has different times available and the selection of up to 11 drying times will also depend on the heat setting that you have selected.



Each press of the button decreases the drying time. If you change your mind, press the Sensor Dry button and the sensing level options are available.



If the Timed Dry option is not available the display will flash and the buzzer will beep three times. The selected time remains displayed after the programme starts and can be changed during the programme if you wish.

Delay Timer



After selecting a programme that has a Delay Timer option, a delay start time can be selected. Each press of the Delay Timer button  advances the delay setting in 30 minutes increments from 0:30 to 9:30 and then increments from 10h to 24h then OFF and then after five seconds cancels the delay.

For delays of 10 hours or more the display counts down the time in hours until 10 hours, then the display shows "9:59" and then continues to count down in minutes.

For delays 9 hours or less the display shows hours and minutes and then counts down in minutes for all of the delay. After the START/PAUSE button  is pressed the delay time can be changed or cancelled. When the delay period finishes the delay icon  is off and the **Time to End** is displayed.

Note: During this period the clothes will tumble occasionally to help prevent creases developing.

Time to End

If the delay icon  is off the time displayed is the Time to End for the programme running. When timed programmes are selected the time displayed throughout the cycle is the actual time remaining. When Automatic programmes are selected the time displayed is an estimate of the time remaining: When the programme is selected the display shows the time required to dry a full load.







The time remaining is constantly monitored during the drying cycle and is updated to show the best forecast. The Time to End is displayed in hours and minutes and counts down each minute. The colons between the hours and minutes in the display flash to show the time is counting down.

The display also shows if there is a problem with your dryer, if this occurs the display will show "F" followed by a fault code number, the three option lights and the START/PAUSE light will also flash amber (see *Troubleshooting*).

Start and Programmes

GB

Choosing a Programme

1. Plug the dryer into the electrical socket.
2. Sort your laundry according to fabric type (see *Laundry*).
3. Open the door and make sure the filter is clean and in place and the water container is empty and in place (see *Maintenance*).
4. Load the machine and make sure that the items are not in the way of the door seal. Close the door.
5. Press the On/Off Button .
6. Select the Programmes selection that corresponds with fabric being dried by checking the Programmes table (see *Programmes*) as well as the indications for each type of fabric (see *Laundry*).
7. Where available, choose Sensor Dry  or Timed Dry  option pressing and releasing the corresponding button until the desired level or time is displayed.
8. Set a delay time and other options as necessary (see *The Display*).
9. If you wish the buzzer to sound at the end of the programme, press the sound button . If you have selected the Crease Care option, this option is not available.
10. Press the START button  to begin. The display will show the estimated time to end.
During the drying programme, you can check on your laundry and take out the items that are dry while the others continue drying. When you close the door again, press START in order to resume drying.
11. During the last few minutes of Drying Programmes before the programme is completed, the final COOL TUMBLE phase  is entered (fabrics are cooled), this phase should always be allowed to complete.
12. To let you know that your programme is complete the buzzer will beep 3 times and the display shows **END** (Note: if the SOUND option was selected the buzzer beeps 3 times every 30 seconds for 5 minutes). Open the door, take your laundry out, clean the filter and replace it. Empty the water container and replace it (see *Maintenance*).
13. Switch dryer off using the On/Off button.



Standby mode

This tumble dryer, in compliance with new energy saving regulations, is fitted with an automatic standby system which is enabled after about 30 minutes if no activity is detected. Press and hold the On-Off button until the dryer reactivates.

n°	Programme	Description of program The duration of the drying cycles can be checked on the display ¹ .
	Max. load	
1	Standard Cotton	<ul style="list-style-type: none"> This is a programme for cotton items. The Standard Cotton programme to EU Regulation 392/2012 is Programme 1 selection with High Heat and Dryness Level Cupboard Dry (the standard/default starting configuration). It is the most efficient programme in terms of energy consumption (to EU.392/2012)
	max.	
2	Shirts	<p>High heat option</p> <ul style="list-style-type: none"> This is a programme for shirts made from cotton. <p>Medium heat option</p> <ul style="list-style-type: none"> This is a programme for shirts made from synthetic materials or a mixture of natural and synthetic materials, such as polyester and cotton. <p>Loads dried using the Cupboard Dry setting are usually ready to wear, the edges or seams may be slightly damp. If this is the case, try turning the shirts inside out and running the programme again for a short period.</p>
	3 kg	
3	Bed & Bath	<ul style="list-style-type: none"> This is a programme for cotton towels and sheets. Loads dried using the Extra Dry setting are usually ready to use, the edges or seams may be slightly damp especially on large items. If this is the case, try opening them out and running the programme again for a short period.
	max.	
4	Anti Allergy	<ul style="list-style-type: none"> This programme has the 'Seal of Approval' endorsement from Allergy UK, which reflects the effective reduction and elimination of allergens from the clothes with the special Anti Allergy cycle. With this programme, thanks to the achievement of constant temperature for an extended period of time, the effects of the most common allergens (including House Mites and Pollen) are neutralised. Can be used on a full size wet load to dry and treat, or on a 4 kg dry load just to treat your laundry.
	max.	
5	Synthetics	<ul style="list-style-type: none"> This is a programme for items of Synthetic or Synthetic/Cotton mixtures. Some fabrics may require a further timed dry period for the desired dryness level, we recommend smaller loads use a low heat timed dry.
	3 kg	
6	Quick Dry	<ul style="list-style-type: none"> This programme gives a reduced drying time for small loads, up to 1kg. <p>Note: Dries your load to the cupboard dry setting.</p>
	1 kg	
7	Jeans	<ul style="list-style-type: none"> This is a programme for jeans made from denim cotton. Before drying your jeans turn the front pockets inside out. Do not mix dark and light coloured items. It can also be used on other garments made from the same material, such as jackets. Loads dried using the Extra Dry setting are usually ready to wear, the edges or seams may be slightly damp. If this is the case, try turning the jeans inside out and running the programme again for a short period. <p>! We do not recommend that you use this programme if your jeans have elastic waist bands, studs or embroidery.</p>
	3 kg	
8	Wool	<ul style="list-style-type: none"> This is a programme for tumble dryer safe garments marked with the symbol . We recommend that garments are turned inside out before drying. Loads dried using this programme are usually ready to wear, but on some heavier garments the edges may be slightly damp. Allow these to dry naturally as over-drying could damage garments. <p>! Unlike other materials, the mechanism of wool shrinkage is irreversible; i.e. it will not stretch back to original size and shape. ! This programme is not suitable for Acrylic garments.</p>
	1 kg	
9	Silk	<ul style="list-style-type: none"> This is a programme for drying your delicate silk. Loads dried using the Cupboard Dry setting are usually ready to use, but on some garments the edges may be slightly damp. If this is the case, try opening them out or turn items inside out and running the programme again for a short period.
	0,5 kg	
10	Delicates	<ul style="list-style-type: none"> This is a programme for drying your delicate clothes ie. Acrylics. Loads dried using this programme are usually ready to wear, but on some heavier garments the edges may be slightly damp. If this is the case, try turning items inside out and running the programme again for a short period.
	2 kg	

Note:



1 - The duration of the program will depend on the size of the load, types of textiles, the spin speed used in your washer and any extra options selected.

n°	Programme	Description of program
	Max. load	The duration of the drying cycles can be checked on the display ¹ .
11	Duvet	<p>! Take care with this programme DO NOT dry any items that are damaged which could result in the filling blocking the filter and air vent resulting in a fire hazard.</p> <ul style="list-style-type: none"> • Must only be used on single size duvets: NOT suitable for double or king size items. • Loads dried using this programme are usually ready to use, but may be slightly damp in places. If this is the case, try opening them out and shaking them and running the programme again for a short period. • Also suitable for down filled jackets. • Select high heat for Cotton Duvets and medium heat for Synthetic duvets.
	-	
12	Baby cycle	<ul style="list-style-type: none"> • This is a programme for drying your baby's small delicate items of clothing and bedding (Cotton and Chenille) and for drying your delicate clothes. • DO NOT dry items such as bibs and nappy pants with plastic coverings. • Loads dried using this programme are usually ready to wear, but on some heavier garments the edges may be slightly damp. If this is the case, try turning items inside out and running the programme again for a short period.
	2 kg	
13	Cuddly Toys	<ul style="list-style-type: none"> • With this programme you can remove dust easier and wash the cuddly toys more often because the drying time is very much reduced compared to drying in the open air. It is a delicate drying cycle that dries at low temperature and with soft mechanical action to maintain at best the original look and shine of the fur. • Note: For allergy protection, just freeze cuddly toys for 24 hours then wash and dry them. Repeat every 6 weeks. • Before drying remove accessories such as clothes, collars or sound boxes and protect plastic eyes with masking tape after drying them with a cloth. • The programme time will vary dependant on the exact make up of the load. The maximum load should not exceed 2.5 kg and no individual item should be greater than 600 g.
	2,5 kg	
14	Heat & Enjoy	<ul style="list-style-type: none"> • This programme helps to heat towels & bathrobes for a warm sensation after a bath or shower. It is also useful for warming clothes before dressing during winter. The cycle heats clothes to 37°C (Body Temperature) and runs at this temperature for a maximum of 4 hours or until you stop the cycle by opening the door. • Note: During this programme a  icon rotates in the display until the target temperature is reached, at which point the  icon flashes.
	-	
15	Easy Iron	<ul style="list-style-type: none"> • Easy Iron is a short 10 minute programme (8 minutes of heat followed by a 2 minutes cool tumble period) which fluffs the fibres of clothing that has been left in the same position/location for an extended period of time. The cycle relaxes the fibres and makes them easier to iron and fold. ! Easy Iron is not a drying programme and should not be used for wet articles of clothing. • For best results: <ol style="list-style-type: none"> 1. Do not load more than maximum capacity. These numbers refer to dry weight: Cotton and Cotton mix -2.5 kg; Synthetics -2; Denim -2. 2. Unload the dryer immediately after the end of the drying cycle, hang, fold or iron the articles and put them away in the closet. Should this not be possible, repeat the cycle.
	2,5 kg	
16	Refresh	<p>! 'Refresh' is not a drying programme and should not be used for wet articles of clothing.</p> <ul style="list-style-type: none"> • It can be used on any load size, but is more effective on smaller loads. • Do not overload your dryer (see <i>Laundry</i>). • This is a 20 minute programme that airs your clothes with cool air. Also use to cool warm clothes.
	-	

Note:

1 - The duration of the program will depend on the size of the load, types of textiles, the spin speed used in your washer and any extra options selected.

The Controls

! Warning, after pressing the START/PAUSE button , the programme cannot be changed. To change a selected programme, press the START/PAUSE button  the light flashes Amber to indicate the programme is paused. Select the new programme and any options required, the light will then flash green. Press the START/PAUSE button  again and the new programme will start.

• Option buttons

These buttons serves to personalise the selected programme according to personal requirements. Not all options are available for all programmes. Some options are incompatible with the ones previously set. If the button of any unavailable option is pressed, the buzzer will beep 3 times. If the option is available, the option light will stay on.

Progress (Drying, Cool Tumble) icons

These are part of the Display, they indicate the progress of the dryer. Each icon comes on as the corresponding phase starts.

Delay Timer (Time Delay)

The start of some programmes (see *The Display and Programmes tables*) can be delayed for up to 24 hours. Ensure the water container is emptied before setting a delayed start.

Extra Care

This Anti-Ageing function for Cottons helps to maintain the brightness of your laundry for a long time, thanks to the correct drum rotation (reduced in the last part of the cycle) and the correct temperature.

Heat Level button and lights

Not all programmes allow you to change the heat level and some programmes allow all three heat level options: Low, Medium and High.

When the heat level options are available pressing this button changes the heat level and the light corresponding to the selection is lit.

Sound



If selected, gives a signal at the end of the drying cycle, to remind you that the clothes are ready to be removed. Not available with the Heat & Enjoy programme.

• DISPLAY “8:88”

The display shows either the amount of time delay remaining or an indication of the amount of time left for a drying programme (see *The Display*). The colons between the hours and minutes in the display flash to show that the time is counting down. When the programme finishes its cool tumble phase the display will show ‘End’.

• Empty Water Icon / Container

(If you have plumbed your dryer to a drain this icon can be ignored, as there is no need to empty the water container). When this icon is on () it reminds you to empty the water container.

If the water container fills during a programme, the heater turns off and the dryer does a period of Cool Tumble then the buzzer sounds, the ‘water container full’ icon  flashes, the display shows “H2O” and the ‘empty water’ icon  is on.

You must empty the water container and restart the dryer or the clothes will not dry. After re-starting the dryer the display will take a few seconds to refresh. To avoid this always empty the water container each time you use the dryer (see *Maintenance*).

• Door Opening

Opening the door (or pressing the Start/Pause Button) during a programme will stop the dryer and have the following effects:

- The START/PAUSE light flashes Amber.
- During a delay phase the delay will continue to count down. The START/PAUSE button must be pressed to resume the delay programme.
- The START/PAUSE button must be pressed to resume the programme. The progress lights will change to show the current status and the Start/Pause light will stop flashing and turn green.
- Changing the Programmes knob will select a new programme and the START/PAUSE Light will flash green. You can use this to select the “Refresh” programme to cool the clothes if you find them dry enough. Pressing the START/PAUSE button to begin new Programme.

• Note

If you have a power cut, switch off the power or remove the plug. When power is restored, plug in the machine, press and hold the ON/OFF button until the dryer reactivates, then press Start/Pause button.

Laundry

GB

Sorting laundry

- Check the symbols on the care labels of the various garments to verify whether the garments can be safely tumble dried.
- Sort laundry according to the type of fabric.
- Empty all pockets and check for loose buttons.
- Close zips and hooks and fasten belts and strings without tightening them.
- Wring out garments to remove the maximum amount of water possible.

! Do not load the dryer when garments are dripping wet.

Maximum load sizes

Do not overload the drum.

The following values indicate the weight of dry garments:





Natural fibres: maximum 8 kg

Synthetic fibres: maximum 3 kg

! Do not overload the dryer as this may result in reduced drying performance.

Care labels

Always check the care labels, especially when placing garments in the tumble dryer for the first time. Below are the most commonly used symbols:

-  May be tumble dried.
-  Do not tumble dry.
-  Tumble dry – high heat.
-  Tumble dry – low heat.

Drying times

Drying times are approximate and may vary depending on the following:

- Amount of water retained by items after the spin cycle: towels and delicate items retain a lot of water.
- Fabrics: items of the same fabric, but with different texture and thickness may have different drying times.
- Amount of laundry: single items and small loads may take longer to dry.
- Drying: if items are to be ironed, they can be removed from the dryer while still slightly damp. Items that require complete drying can be left longer.
- Heat setting.
- Temperature of the room: the lower the temperature of the room, the longer it will take for the dryer to dry clothing.
- Bulk: certain bulky items require special care during the drying process. We suggest removing these items and replacing them in the dryer once they have been shaken out: repeat this procedure several times during the course of the drying cycle.

! Do not over-dry items.

All fabrics contain natural dampness which helps to keep them soft and fluffy.

One day your dryer seems not to be working. Before you call your Service Centre (see Service), go through the following troubleshooting suggestions:

Problem:

The tumble dryer won't start.



Possible causes / Solution:

- The plug is not plugged into the socket, or not making contact.
- There has been a power failure.
- The fuse has blown. Try to plug another appliance into the socket.
- You are using an extension cord? Try to plug the dryer's power cord directly into the socket.
- The door is not closed securely?
- The programme has not been set properly (**see Start and Programmes**).
- The Start/Pause button has not been pressed (**see Start and Programmes**).

Drying cycle will not begin.

- You have set a delayed time (**see Start and Programmes**).

Its taking a long time to dry.

- The filter has not been cleaned (**see Maintenance**).
- The water container needs emptying... The 'water container full' icon  is flashing, the display shows "H2O" and the 'empty water' icon  is on (see Maintenance).
- The condenser needs cleaning? (**see Maintenance**).
- The temperature setting is not ideal for the type of fabric you are drying (**see Start and Programmes, and see Laundry**).
- The correct drying time has not been selected for the load (**see Laundry**).
- The air intake grille is obstructed (**see Installation, and see Maintenance**).
- The items were too wet (**see Laundry**).
- The dryer was overloaded (**see Laundry**).

The 'water container full' icon  is flashing and "H2O" displayed but the dryer has only been running for a short period.

- The water container was probably not emptied at the start of the programme. Do not wait for the empty water signal, always check and empty the container before starting a new drying programme (**see Maintenance**).

Empty water icon  is on and the water container is not full.

- This is normal. If the icon is on it is just a reminder to empty the container (see Start and Programmes).

Programme finishes and clothes are damper than expected.

- ! For safety the dryer has a maximum programme time of 5 hours. If an automatic programme has not sensed the required final moisture in this time the dryer will complete the programme and stop. Check the above points and run the programme again, if the results are still damp, contact the Service Centre (**see Service**).

The display shows a fault code F followed by one or two numbers.

- If the display shows a fault:
 - Turn off and remove the plug. Clean the filter and the condenser (**see maintenance**). Then replace the plug, turn on and start another programme. If a fault is then displayed: Note down the code and contact the Service Centre (**see Service**).



19515643602
06/2019

GB

Before contacting the Technical Assistance Centre:

- Follow the troubleshooting guide to check whether problems can be solved personally (see *Troubleshooting*).
- If not, switch the dryer off and contact the Technical Assistance Centre closest to you.

Spare parts

This dryer is a complex machine. Attempting to repair it personally or with the aid of an unqualified personnel may put the safety of people at risk, damage the machine or invalidate the spare parts guarantee. Always contact a qualified technician when experiencing problems with this machine.

Product Guarantee And Repair Information

Guarantee

12 Months Parts and Labour Guarantee

Your appliance has the benefit of our manufacturer's guarantee, which covers the cost of breakdown repairs for twelve months from the date of purchase.

This gives you the reassurance that if, within that time, your appliance is proven to be defective because of either workmanship or materials, we will, at our discretion, either repair or replace the appliance at no cost to you:

This guarantee is subject to the following conditions:

- The appliance has been installed and operated correctly and in accordance with our operating and maintenance instructions.
- The appliance is used only on the electricity or gas supply printed on the rating plate.
- The appliance has been used for normal domestic purposes only.
- The appliance has not been altered, serviced, maintained, dismantled, or otherwise interfered with by any person not authorised by us.
- Any repair work must be undertaken by us or our appointed agent.
- Any parts removed during repair work or any appliance that is replaced become our property.
- The appliance is used in the United Kingdom or Republic of Ireland.

The guarantee does not cover:

- Damage resulting from transportation, improper use, neglect or interference or as a result of improper installation.
- Replacement of any consumable item or accessory. These include but are not limited to: plugs, cables, batteries, light bulbs, fluorescent tubes and starters, covers and filters.
- Replacement of any removable parts made of glass or plastic.

THIS GUARANTEE WILL NOT APPLY IF THE APPLIANCE HAS BEEN USED IN COMMERCIAL OR NON-DOMESTIC PREMISES.

Repairs and After Sales

For product help and advice, repairs, spare parts or accessories, we're here to help.

For local repair engineers - **03448 111 606** ROI - **0818 313 413** UK standard local rate applies ROI local Irish rate applies

For Parts and Accessories visit: parts.hotpoint.co.uk/shop

Please remember to register your appliance at www.hotpointservice.co.uk to activate your 10 year parts guarantee.

Please note, our advisors will require the following information: model number, serial number

This information can be found on the data plate located behind the door.

Information on recycling and disposal

As part of our continual commitment towards environmental protection, we reserve the right to use recycled quality components to reduce costs for our customers and to minimise materials wastage.

- Disposing of the packaging materials: follow local regulations to allow for recycling of packaging materials.
- In order to minimise the risk of injury to children, remove the door and plug, then cut the power supply cord flush with the appliance. Dispose of these parts separately to prevent the appliance from being connected to a power supply socket.

Disposal of old household appliances



European Directive 2012/19/EC concerning Waste Electrical and Electronic Equipment (WEEE) states that household appliances should not be disposed of using the normal solid urban waste cycle. Exhausted appliances should be collected separately in order to optimise the cost of re-using and recycling materials comprising the machine, while preventing potential damage to public health and the environment. The crossed-out wheeled bin symbol appears on all products to remind owners of the obligations regarding separate waste collection.

Owners should contact their local authorities or appliance dealers for further information concerning the correct disposal of household appliances.



This appliance has been designed, constructed and distributed in compliance with the requirements of European Directives:

- LVD 2014/35/EU, EMC 2014/30/EU and RoHS 2011/65/EU.