

TUMBLE DRYER

GB

English

AQUALTIS

AQC9 BF7

Contents

Installation, 2

Laundry, 3

Warnings, 4

Care and Maintenance, 6

Dryer Description, 8

The Display, 9

Start and Programmes, 10

Troubleshooting, 15

Service, 16

www.hotpoint.eu



This symbol reminds you to read this instruction manual.

! Keep this manual at hand for immediate reference whenever necessary. Always store this manual close to the tumble dryer and remember to pass it on to any new owners when selling or transferring the appliance, so they may familiarise with the warnings and suggestions herein contained.

! Read these instructions carefully: the following pages contain important information on installation and useful suggestions for operating the appliance.

Installation

GB

Where to install the tumble dryer

If the dryer is installed below a worktop, ensure there are 10 mm between the upper panel of the dryer and any objects above it, and 15 mm between the sides of the machine and the walls or furniture units adjacent to it. This ensures adequate air circulation.

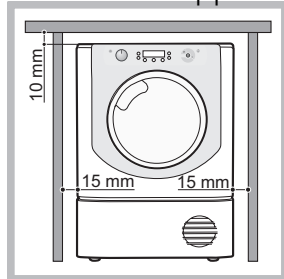

The appliance must be installed with the rear surface placed against a wall.

Ventilation

Make sure that the dryer is installed in a room free of humidity and with adequate air circulation. The flow of air around the dryer is essential to allow water to condense during drying; the dryer will not function properly if it is placed in an enclosed space or inside a cabinet.

Some condensation may form if the dryer is used in a small or cold room.

Water drain

If your dryer is installed next to a drain the water can be plumbed into this drain. This does away with the need to empty the water container. If the dryer is stacked onto or installed next to a washing machine it can share the same drain. The height of the drain must be less than 3' (1 m) from the bottom of the dryer.

Remove existing hose from position shown in picture A and fit a suitable length of hose and connect as shown in picture B.

The drain tube has to be below 1 m from the bottom of the Dryer

Make sure that the hose is not squashed or kinked when the dryer is in its final location.

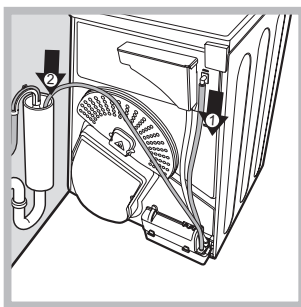

Picture A

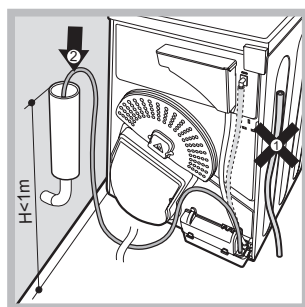

Picture B

⚠ We do not recommend that the dryer is installed in a cupboard but the dryer must never be installed behind a lockable door, a sliding door or a door with a hinge on the opposite side to that of the dryer door.

Electrical connections

Before plugging the appliance into the socket,

check the following:

- ⚠ Make sure your hands are dry.
- ⚠ The socket must have an earth connection.
- ⚠ The socket must be able to withstand the machine's maximum power output as indicated on the rating plate.
- ⚠ The power supply voltage must fall within the values indicated on the data plate.
- ⚠ Do not use extension leads. Do not pull the power supply cable. Do not use multiple plug adaptors if the appliance is fitted with a plug. For appliances with fitted plug, if the plug is not suitable for your socket outlet, contact a qualified technician.

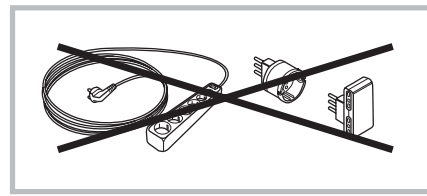

- ⚠ The dryer must not be installed outdoors, even if the space is sheltered.
- ⚠ Once installed, the dryer's electrical wire and plug must be within reach.
- ⚠ The power cord must not be bent or squashed.
- ⚠ If the plug being replaced is a non-rewirable type, then the cut-off plug must be disposed of safely. DO NOT leave it where it can be inserted into a socket and create a shock hazard.
- ⚠ The power must be regularly checked. If the supply cord is damaged, it must be replaced by service agent. (see Assistance).
- ⚠ **The manufacturer denies any responsibility should any of these rules not be followed.**
- ⚠ **If in doubt about any of the above consult a qualified electrician.**

Preliminary information

Once the tumble dryer is installed, clean the inside of the drum before operating it and remove any dirt accumulated during transportation.

Sorting laundry

- Check the symbols on the care labels of the various garments to verify whether the garments can be safely tumble dried.
- Sort laundry according to the type of fabric.
- Empty all pockets and check for loose buttons.
- Close zips and hooks and fasten belts and strings without tightening them.
- Wring out garments to remove the maximum amount of water possible.

! Do not load the dryer when garments are dripping wet.

Maximum load sizes

Do not overload the drum.

The following values indicate the weight of dry garments:





Natural fibres: maximum 9 kg

Synthetic fibres: maximum 3 kg

! Do not overload the dryer as this may result in reduced drying performance.

Care labels

Always check the care labels, especially when placing garments in the tumble dryer for the first time. Below are the most commonly used symbols:

-  May be tumble dried.
-  Do not tumble dry.
-  Tumble dry – high heat.
-  Tumble dry – low heat.

Drying times

Drying times are approximate and may vary depending on the following:

- Amount of water retained by items after the spin cycle: towels and delicate items retain a lot of water.
- Fabrics: items of the same fabric, but with different texture and thickness may have different drying times.
- Amount of laundry: single items and small loads may take longer to dry.
- Drying: if items are to be ironed, they can be removed from the dryer while still slightly damp. Items that require complete drying can be left longer.
- Heat setting.
- Temperature of the room: the lower the temperature of the room, the longer it will take for the dryer to dry clothing.
- Bulk: certain bulky items require special care during the drying process. We suggest removing these items and replacing them in the dryer once they have been shaken out: repeat this procedure several times during the course of the drying cycle.

! Do not over-dry items.



All fabrics contain natural dampness which helps to keep them soft and fluffy.

The drying times provided refer to the automatic Cupboard dry programmes.

The Timed drying settings are also indicated to enable you to select the most suitable timed option.

The weight refers to dry items.

Drying times

Cottons 		1 kg	2 kg	3 kg	4 kg	5 kg	6 kg	7 kg	8 kg	9 kg
	Automatic minutes	30-40	40-55	55-70	70-80	80-90	95-120	120-140	130-160	140-170
	Timed	30 or 60	60 or 90	60 or 90	90 or 120	90 or 120	120 or 160	120 or 160	160	160 or 180
High heat	Drying times 800-1000 rpm in washing machine									
Synthetics 		1 kg			2 kg			3 kg		
	Automatic minutes	30-40			40-50			50-70		
	Timed Dry setting	30 or 60			30 or 60			60 or 90		
Low heat	Drying times on reduced spin in washing machine									
Acrylics		1 kg				2 kg				
	Low heat	Timed Dry setting				30		60		

Warnings

GB

! This appliance has been designed and built according to international safety standards. These warnings are given for safety reasons and must be followed carefully.

General safety

- This appliance can be used by children aged from 8 years and above and persons with reduced physical, sensory or mental capabilities or lack of experience and knowledge if they have been given supervision or instruction concerning use of the appliance in a safe way and understand the hazards involved.
- This tumble dryer has been designed for home, and not professional, use.
- Do not touch the appliance while barefoot or with wet hands or feet.
- Unplug the machine by pulling on the plug, not the cord.
- After using the dryer, turn it off and unplug it. Keep the door closed to make sure that children do not use it as a toy.
- Children should be supervised to ensure that they do not play with the dryer.
- Cleaning and user maintenance shall not be made by children without supervision.
- Children of less than 3 years should be kept away from the appliance unless continuously supervised.
- The appliance must be installed correctly and have proper ventilation. The air intake at the front of the dryer should never be obstructed (see *Installation*).
- Never use the dryer on carpeting where the pile height would prevent air from entering the dryer from the base.
- Check to see if the dryer is empty before loading it.
-  The back of the dryer could become very hot. Never touch it while in use.
- Do not use the dryer unless the filter, water container and condenser are securely in place (see *Maintenance*).
- Do not overload the dryer (see *Laundry* for maximum loads).
- Do not load items that are dripping wet.
- Carefully check all instructions on clothing labels (see *Laundry*).
- Do not tumble dry large, very bulky items.
- Do not tumble dry acrylic fibres at high temperatures.

- Do not turn off the dryer when there are still warm items inside.
- Clean the filter after each use (see *Maintenance*).
- Empty the water container after each use (see *Maintenance*).
- Clean the condenser unit at regular intervals (see *Maintenance*).
- Do not allow lint to collect around the dryer.
- Never climb on top of the dryer. It could result in damage.
- Always follow electrical standards and requirements (see *Installation*).
- Always buy original spare parts and accessories (see *Service*).

To minimise the risk of fire in your tumble dryer, the following should be observed:

- Tumble dry items only if they have been washed with detergent and water, rinsed and been through the spin cycle. It is a fire hazard to dry items that HAVE NOT been washed with water.
- Do not dry garments that have been treated with chemical products.
- Do not tumble dry items that have been spotted or soaked with vegetable or cooking oils, this constitutes a fire hazard. Oil-affected items can ignite spontaneously, especially when exposed to heat sources such as a tumble dryer. The items become warm, causing an oxidation reaction with the oil. Oxidation creates heat. If the heat cannot escape, items can become hot enough to catch fire. Piling, stacking or storing oil-affected items can prevent heat from escaping and so create a fire hazard. If it is unavoidable that fabrics containing vegetable or cooking oil or those that have been contaminated with hair care products be placed in a tumble dryer they should first be washed with extra detergent - this will reduce, but not eliminate the hazard. They should not be removed from the dryer and piled or stacked while hot.
- Do not tumble dry items that have previously been cleaned in or washed in, soaked in or soiled with petrol/ gasoline, dry cleaning solvents or other

flammable or explosive substances. Highly flammable substances commonly used in domestic environments including cooking oil, acetone, denatured alcohol, kerosene, spot removers, turpentine, waxes and wax removers. Ensure these items have been washed in hot water with an extra amount of detergent before being dried in the tumble dryer.

- Do not tumble dry items containing foam rubber (also known as latex foam), or similarly textured rubber like materials. Foam rubber materials can, when heated, produce fire by spontaneous combustion.
- Fabric softener or similar products should not be used in a tumble dryer to eliminate the effects of static electricity unless the practice is specifically recommended by the manufacturer of the fabric softener product.
- Do not tumble dry undergarments that contain metal reinforcements eg. bras with metal reinforcing wires. Damage to the tumble dryer can result if the metal reinforcements come loose during drying.
- Do not tumble dry rubber, plastic articles such as shower caps or babies waterproof covers, polythene or paper.
- Do not tumble dry rubber backed articles, clothes fitted with foam rubber pads, pillows, galoshes and rubber coated tennis shoes.
- Remove all objects from pockets such as lighters and matches.

! WARNING: Never stop the dryer before the end of the drying cycle unless all items are quickly removed and spread out so that the heat is dissipated.

Save energy and respect the environment

- Wring out all items to eliminate excess water before tumble drying (if you use a washing machine first, select a high spin cycle). Doing this will save time and energy during drying.
- Always dry full loads - you save energy: single items or small loads take longer to dry.
- Clean the filter after each use to contain energy consumption costs (see *Maintenance*).

Maximum load sizes: 9 kg

Power Consumption			
Off-mode (Po) - Watts			0.17
Left-on mode (PI) - Watts			0.17
Programmes	Kg	kWh	Minutes
Standard Cotton* ◁	9	5.25	161
Standard Cotton ◁	4.5	2.79	92
Synthetics	3	1.3	80
*This is the reference programme for the energy label and suitable to dry normal wet cotton laundry. This is the most efficient programme in terms of energy consumption for drying wet cotton laundry.			

Care and maintenance

GB

Disconnecting the power supply

! Disconnect the dryer when not in use or during cleaning and maintenance operations.

Cleaning the filter after each cycle

The filter is a fundamental component of the dryer: its function is to collect lint and fluff that form during drying.

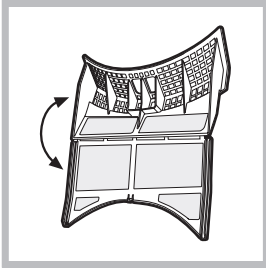

Clean the filter once drying is completed, by rinsing it under running water or cleaning it with a vacuum cleaner. Should the filter become clogged, the flow of air

inside the dryer will be seriously hampered: drying times becomes longer and more energy is consumed. Moreover, the dryer may become damaged.

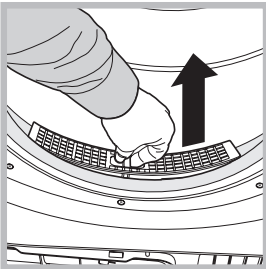

The filter is located in front of the dryer seal (see Picture).

Removing the filter:
1. Pull the filter's plastic handle upwards (see Picture).

2. Clean the fluff off the filter and replace it correctly. Ensure that the filter is pushed fully home.

! Do not use the dryer unless the filter has been replaced in its holder.

Checking the drum after each cycle

Rotate the drum manually to remove smaller items (handkerchiefs) that could have been left inside the dryer.

Cleaning the drum

! Avoid using abrasives, steel wool or stainless steel cleaning agents to clean the drum. A coloured film may appear on the stainless steel drum surface: it may be caused by a combination of water and/or cleaning agents such as wash-softeners. This coloured film does not affect the dryer's performance.

Emptying the water container after each cycle

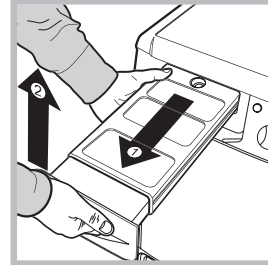

Remove the water container and empty it into a sink or other suitable drain outlet, then replace it correctly. Always check the water container and empty it before starting a new drying cycle.

-Failure to empty the water container may cause the following:

- The dryer stops heating (thus the load may still be damp at the end of the drying cycle).
- The "Empty water container" LED activates to show that the water container is full.

Priming the Water Collection System

When your dryer is new, the Water Container will not collect Water until the system is primed, this will take 1 or 2 drying cycles. Once primed it will collect Water during every cycle.

Cleaning the condenser unit.

• Remove the condenser (see Picture below) unit regularly (monthly) and clean off any fluff deposits from the plates by rinsing it with cold water running on the rear end of the condenser.

Removing the condenser:

1. Disconnect the dryer from the power supply and open the door.

2. Open the condenser cover (see Picture below), unlock the three catches by turning them 90° anti-clockwise, then pull on the grip to remove the condenser.

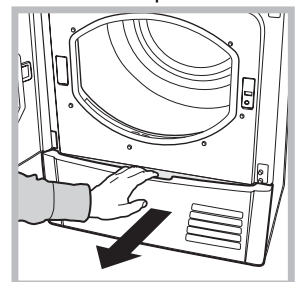

3. Clean the surface of the seals and replace the unit with the arrows pointing upwards, while making sure that the catches are securely fixed.

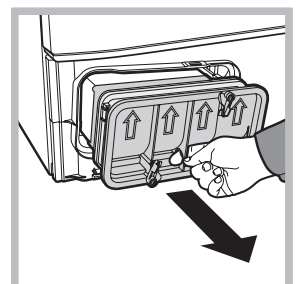

Cleaning the tumble dryer

- The external metal, plastic and rubber parts can be cleaned with a damp cloth.
- Clean the front air intake grille regularly (every 6 months) with a vacuum cleaner to remove any lint, fluff or dust deposits. Furthermore, remove any lint deposits from the front part of the condenser and from the filter area, using a vacuum cleaner every so often.

! Do not use solvents or abrasives.

! Have the dryer checked regularly by authorised technical personnel in order to ensure that the electrical and mechanical parts work safely (see Assistance).

Quick Tips

! Remember to clean your filter and Condenser unit after each load.

! Remember to empty your water container after each load.

! Doing this will keep your machine working at its BEST!

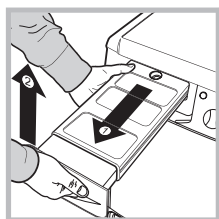

Water Container

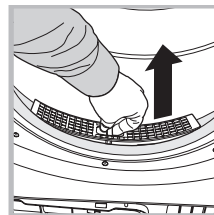

Filter

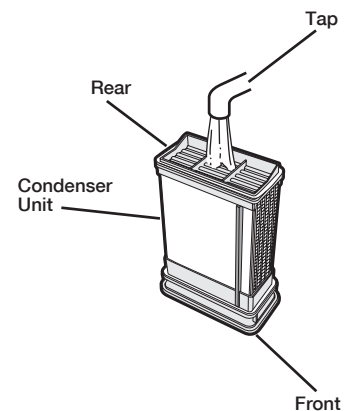
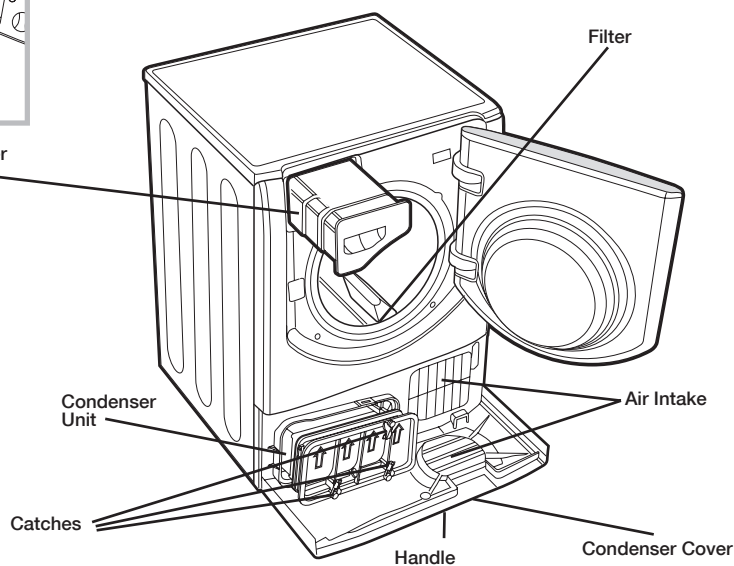

Dryer Description

GB

To open door

Pull on handle

Condenser unit
(cover open)

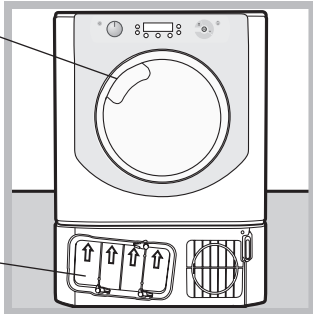

The Features

Rating Plate

Water container

Filter

Model & Serial Numbers

Air Intake Grille

Condenser cover handle
(Pull to open)

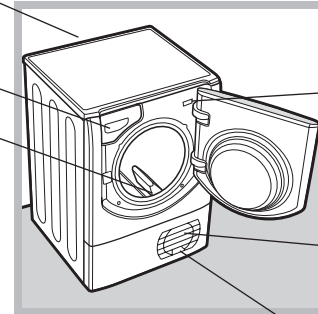

Control Panel

On/Off Button & Light

Option Buttons and Lights

ECO Light

Start/Pause Button & Light

Programme Progress Light

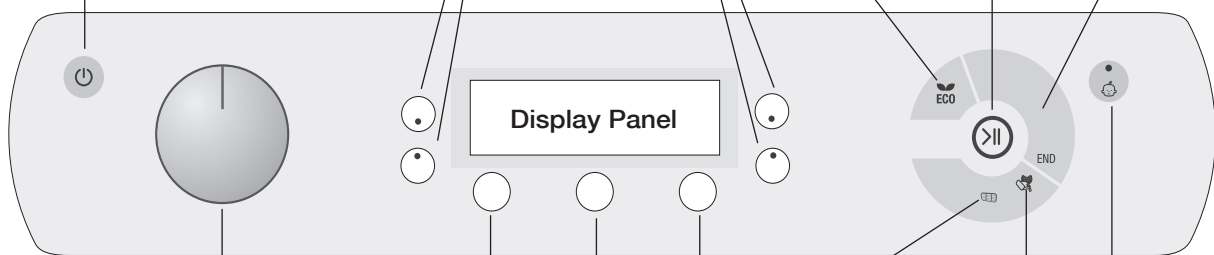

Programme Knob

Sensor Dry

Timed Dry

Delay Timer

Clean Condenser Light

Empty Water / Clean Filter Light

Child Lock Button & Light

The **On/Off** button/light , if the dryer is running and this button is pressed and held for more than 3 seconds the dryer is turned off. The light signals that your dryer is in use or ready to select a programme.

The **Programmes** knob sets the programme: rotate until the indicator is pointing to the programme you want to select (see *Start and Programmes*).

The **Option** buttons/ lights select available options for your selected programme. The lights indicate that the option has been selected (see *Start and Programmes*).

The **Display Panel** has three sections: Sensor Dry = Drying level, Timed dry = Drying time and Time to End / Delay start each with a corresponding selection button (see *The Display*).

START/PAUSE button with indicator light : when the green indicator light flashes slowly, press the button to start the programme. When the cycle has started, the indicator light is illuminated in a fixed manner. To pause the programme, press the button again; the indicator light will turn orange and begin to flash again.

To restart the programme from the point at which it was interrupted, press the button again (see *Start and Programmes*).

The **Programme Progress Lights** indicate each state of the programme by turning on as appropriate (see *Start and Programmes*).

Note: this light also flashes amber during post care phase.

The **Empty Water** indicator “h2o” signals that the water container should be emptied. The light will take a few seconds to go out after replacing the empty water container; the dryer must be running for this to happen (see *The Controls*).

Note: if the water bottle is full the display shows “h2o” and the  indicator flashes, the heat is turned off and your clothes will not dry.

The **Empty Water / Clean Filter** Light  gives a reminder before every programme, that its essential to clean the filter and empty the water container every time the dryer is used (see *Maintenance and Care*).

The **Clean Condenser** Light  gives a reminder, that its essential to clean the condenser at regular intervals (see *Maintenance and Care*).

The **Child Lock** button/light  Press and hold this button after selecting your programme and any options. This prevents the programme settings from being changed.

When the light is lit the other buttons and programme knob are disabled. Hold the button to cancel and the light will go out.

ECO Light - this light is illuminated as you select options that use less energy (see *the controls*).

The Display has three sections each with its corresponding button.

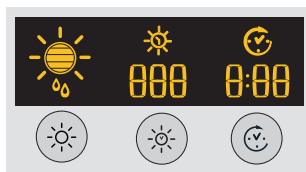

Sensor Dry

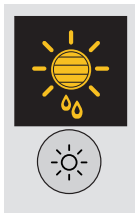

After selecting a programme that has a Sensor Dry Option, press and release the button until the required dryness sensing level is displayed. If the sensing option is not available the display will flash and the buzzer beeps three times.

! Some drying programmes are not compatible with all sensor drying levels.

Dryness levels available

- ☾ **Damp dry:** the most delicate level which makes sure that your clothes are not dripping wet. After a hand-wash the perfect level to then hang your clothes if you do not want to tumble dry them all the way to the end.
- ☀ **Iron Dry:** a very delicate drying, It is useful for garments you would like to iron afterwards.
- ☀ **Hanger plus:** just the drying status to hang delicate garments up (as curtains).
- ☀ **Hanger Dry:** just the drying level to hang the garments up.
- ☀ **Light dry:** ideal for delicate clothes to be folded and placed into the cupboard.
- ☀ **Cupboard Dry:** the garments are completely dry and are ready to be folded and placed in the cupboard.
- ☀ **Ready to Wear:** used for clothes to be worn straight away once the cycle is completed.

Timed Dry

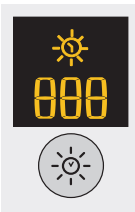

After selecting a Programme that has a Timed Dry Option, press the Timed Button to select a drying time. The display will reduce the selected time each time you press and release this button (*see Start and Programmes*). Each press decreases the set time **180, 160, 120, 90, 60, 30, 20** and then repeats. If the Timed Dry option is not available the display will flash and the buzzer beeps three times. The selected time remains displayed after the programme starts and can be changed during the programme if you wish.

! You can either choose a sensor dry level or a drying time.

Delay Timer



After selecting a Programme that has a Delay Start Option a delay start time can be selected.

Each press of the Delay start button ☹ advances the delay setting in 1 hour increments from "1h" to "24h" then "OFF" and then after five seconds cancels the delay.

For delays of 10 hours or more the display counts down the time in hours until 10 hours, then the display shows "9:59" and then counts down in minutes. For delays of 9 hours or less the display shows hours and minutes and then counts down in minutes for all of the delay.

After the Start/Pause Button >|| is pressed the delay time can be changed or cancelled, if you wish.

When the delay period finished the ☹ symbol is off and the **Time to End** is displayed, if you wish.

If you have chosen a timed drying the display during programming will show the drying time only in the timed drying

display in the middle. After having pressed start the machine will turn the time display on and visualize the countdown of the programme time.

Time to End

If the delay icon ☹ is off the time displayed is the **Time to End** of the programme running.

When timed programmes are selected the time displayed throughout the cycle is the actual time remaining.

When an Automatic programme is selected the time displayed is an estimate of the time remaining.

When the programme is selected the display shows the time required to dry a full load. The remaining time is constantly monitored during the drying cycle and is updated to show the best forecast.

The time to end is displayed in hours and minutes and counts down each minute.





The colon between the hours and minutes display flashes to show that the time is counting down.

The Display also shows if there is a problem with your dryer, if this occurs the display will show F followed by a fault code number, the four option lights and the pause light will also flash Orange (*see Troubleshooting*).

Start and Programmes

GB

Choosing a Programme

1. Plug the dryer into the electrical socket.
 2. Sort your laundry according to fabric type (see *Laundry*).
 3. Open the door and make sure the filter is clean and in place and the water container is empty and in place (see *Maintenance*).
 4. Load the machine and make sure that the items are not in the way of the door seal. Close the door.
 5. If the ON/Off light is not lit; press the On/Off Button .
 6. Select the Programmes selection that corresponds with fabric being dried by checking the Programmes table (see *Programmes*) as well as the indications for each type of fabric (see *Laundry*).
 7. Where available, choose Sensor Dry  or Timed Dry  option pressing and releasing the corresponding button until the desired level or time is displayed.
- ! See programmes table, for more details.
8. Set a delay time and other options as necessary (see *The Display*).
 9. If you wish the buzzer to sound at the end of the programme, press the Sound button . If you have selected the Crease Care option, this option is not available.
 10. Press the START button  to begin. The display will show the estimated time to end.

During the drying programme, you can check on your laundry and take out the items that are dry while the others continue drying. When you close the door again, press START in order to resume drying.

11. During the last few minutes of Drying Programmes before the programme is completed, the final COOL TUMBLE phase is entered (fabrics are cooled), this phase should always be allowed to complete.

12. To let you know that your programme is complete the buzzer will beep 3 times and the display shows **END** (Note: if the SOUND option was selected the buzzer beeps 3 times every 30 seconds for 5 minutes).

Open the door, take your laundry out, clean the filter and replace it. Empty the water container and replace it (see *Maintenance*). If the Crease Care  option has been selected and you do not take the clothes out immediately the clothes will tumble occasionally for 10 hours or until you open the door.

13. Switch dryer off using the On/Off button.

Standby mode

This tumble dryer, in compliance with new energy saving regulations, is fitted with an automatic standby system which is enabled after about 30 minutes if no activity is detected. Press the On-Off button to reactivate the dryer.

Special Programmes

Easy Iron Programme

Easy Iron is a short 10 minute programme (8 minutes of heat followed by a 2 minutes cool tumble period) which fluffs the fibres of clothing that has been left in the same position/location for an extended period of time. The cycle relaxes the fibres and makes them easier to iron and fold.

! Easy Iron is not a drying programme and should not be used for wet articles of clothing.

For best results:

1. Do not load more than maximum capacity. These numbers refer to dry weight:

Fabric:	Max
Cotton and Cotton mix	2.5 kg
Synthetics	2
Denim	2

2. Unload the dryer immediately after the end of the drying cycle, hang, fold or iron the articles and put them away in the closet. Should this not be possible, repeat the cycle.

The Easy Iron effect varies from one fabric to the next. It works very well on traditional fabrics like Cotton or Cotton mix, and less well on acrylic fibres and on materials such as Tencel.*

Wool Programme

- This is a programme for tumble dryer safe garments marked with the symbol .
- It can be used for load sizes up to 1 kg (approximately 3 sweaters).
- We recommend that garments are turned inside out before drying.
- This programme will take about 60 minutes, but may take longer depending on the size and density of the load and the spin speed used in your washer.
- Loads dried using this programme are usually ready to wear, but on some heavier garments the edges may be slightly damp. Allow these to dry naturally as over-drying could damage garments.

! Unlike other materials, the mechanism of wool shrinkage is irreversible; i.e. it will not stretch back to original size and shape.

! This program is not suitable for Acrylic garments.

Jeans

- This is a programme for Jeans made from Denim Cotton. Before drying your Jeans turn the front pockets inside out.
 - It can be used for load sizes up to 3 kg (approximately 4 pairs).
 - It can also be used on other garments made from same material such as jackets.
 - The duration of this programme will depend on the size of the load, the dryness setting selected and the spin speed used in your washer.
 - Loads dried using this programme are usually ready to wear; the edges or seams may be slightly damp. If this is found try turning the jeans inside out and running the programme again for a short period.
 - Use this cycle only for a 100% cotton load, do not mix dark and light coloured items. Do not use this cycle for garments with embroidery and accessories (pins,...), turn the pockets insideout
- ! We do not recommend that you use this programme if your jeans have elastic waist bands or embroidery.

Shirts - Low Heat option

- This is a programme for Shirts made from synthetic materials or a mixture of natural and synthetic materials such as Polyester and Cotton.
- It can be used for load sizes up to 3 kg (approximately 14 shirts).
- The duration of this programme will depend on the size of the load, the dryness setting selected and the spin speed used in your washer.
- Loads dried using this programme are usually ready to wear; the edges or seams may be slightly damp. If this is found try turning the shirts inside out and running the programme again for a short period.

Shirts - High Heat option

- This is a programme for Shirts made from Cotton.
- It can be used for load sizes up to 3 kg (approximately 10 shirts).
- The duration of this programme will depend on the size of the load, the dryness setting selected and the spin speed used in your washer.
- Loads dried using this programme are usually ready to wear; the edges or seams may be slightly damp. If this is found try turning the shirts inside out and running the programme again for a short period.

Silk

- This is a programme for drying your Delicate Silk.
- It can be used for load sizes up to 0.5 kg.
- The duration of this programme will depend on the size of the load, the dryness setting selected and the spin speed used in your washer.
- Loads dried using this programme are usually ready to use, but on some heavier garments the edges may be slightly damp. If this is found try removing the load and open them out then run the programme again for a short period.
- Only for garments labelled suitable for tumble drying.

Duvet programmes

! Take care with these programme do not dry any items that are damaged which could result in the filling blocking the filter and air path resulting in a fire hazard.

- Must only be used on Single size duvets not suitable for double or king size items.
- Loads dried using this programme are usually ready to use, but may be slightly damp in places. If this is found try removing the load and open them out and shake then run the programme again for a short period.
- Also suitable for down filled jackets.

Duvet - High Heat option

- This is a programme for drying your Cotton Duvets. With Cotton outer cover and down filling.
- The duration of this programme will depend on the size of the load and the spin speed used in your washer.
- Only for garments labelled suitable for tumble drying.

Duvet - Low Heat option

- This is a programme for drying your Synthetic Duvets, with synthetic filling.
- The duration of this programme will depend on the size of the load and the spin speed used in your washer.
- Only for garments labelled suitable for tumble drying.

Baby Delicate

- This is a programme for drying your baby's small delicate items of clothing and bedding (Cotton and Chenille) and for drying your Delicate Clothes.
- Do not dry items such as bibs and nappy pants with plastic coverings.
- It can be used for load sizes up to 2 kg.
- The duration of this programme will depend on the size of the load, the dryness setting selected and the spin speed used in your washer.
- Loads dried using this programme are usually ready to use, but on some heavier garments the edges may be slightly damp. If this is found try turning them inside out and running the programme again for a short period.

Bed & Bath

- This is a programme for Cotton Towels and sheets.
- It can be used for load sizes up to 9 kg.
- The duration of this programme will depend on the size of the load, the dryness setting selected and the spin speed used in your washer.
- Loads dried using this programme are usually ready to use; the edges or seams may be slightly damp especially on large items. If this is found try opening them out and running the programme again for a short period.

Refresh

Thanks to a cool air flow, oxygen penetrates the fibers and transports unpleasant odors such as cigarette smoke, frying, smog out of the clothes. With this short program, you can easily refresh your garments in just 20 minutes.

! Airing is not a drying programme and should not be used for wet articles of clothing.

- It can be used on any load size up to 9 kg, but is more effective on smaller loads.
- 20-minute programme that airs your clothes with cool air. Use also to cool warm clothes.

Anti Allergy

The programme has the 'Seal of Approval' endorsement from 'Allergy UK', which reflects the effective reduction and elimination of allergens from the clothes. With this programme, thanks to the achievement of constant temperature for an extended period of time, the effects of the most common allergens (including House Dust Mite) are neutralized.

Can be used on wet load to dry and treat or on a dry load just to treat your laundry. Maximum load is 9 kg for a wet load and 4 kg for a dry load.

Quick Dry

• Your drying time for small loads is very much reduced with a huge time saving up to 53% on cottons (with High Heat option) and 50% on synthetics (with Low Heat option).

Load: 1 Kg. Dryness level: only Cupboard Dry

Activewear

• This programme is specific for drying water-repellent fabrics and sports jackets (e.g. Gore-Tex, polyester, nylon). Drying the garment after a wash cycle has a beneficial effect as it reactivates the garment's water-repellent treatment.

It can be used for loads of up to 2 kg. The duration of this programme will depend on the size of the load, the dryness setting selected and the spin speed used in your washer. Dryness level: only Cupboard Dry

Cuddly Toys

• With the cuddly toy cycle user can remove dust easier and wash the cuddly toys more often because the drying time is very much reduced compared to drying in the open air. It's a delicate drying cycle that dries at low temperature and with soft mechanical action to maintain at best the original look and the shine of the hair.

Note: For allergy protection, just freeze for 24hrs your cuddly toys, wash and dry. Repeat every 6 weeks. Before drying remove accessories such as clothes, collars, or sound boxes and protect plastic eyes (using masking tape).

The programme time will vary dependant on the exact make up of the load. The maximum load should not exceed 2.5 kg and no individual item should be greater than 600 g.

Heat & Enjoy

• The Heat & Enjoy cycle helps to heat towels & bathrobes for a warm sensation after a bath or a shower. It is also useful for warming clothes before dressing during winter.





















The cycle heats the clothes up to 37° (the body temperature) and keeps the same temperature for a maximum of 4 hours or until the user stops the cycle by opening the door.

Load: 3 Kg.

! Note: during this programme a  icon rotates in the display until the temperature target is reached at which point the dryness level icon flashes.

Sensor Drying and Timed Drying





































































































































First select a programme (see programmes table).

Programme	What it does	How to set it	Notes / Options available
Sensor Drying	Always use Sensor Dry if possible for drying your clothes. It will guarantee you best drying results. The heat setting depends on the programme (material option) selected.	1. Press and release the sensor Dry button until the display shows the desired selection. Each press advances  ,  ,  ,  ,  ,  ,  and then repeats. ! Some sensing programmes do not have all 7 dryness level options. 2. Select any Options if required. 3. Press the Start Button  .	Options available Sound  or Crease care  . Delay Start  . High Heat  .  . Extra Care  . Consult suggested drying times (see Laundry). The last few minutes of these programmes is the cool tumble phase.
Timed Drying (180, 160, 120, 90, 60, 30 or 20 minutes)	Always use timed drying option if you want to decide the drying time. The heat setting depends on the Programme (material option) selected.	1. Press and release the Timed Button until the display shows the required selection. Each decreases time 180, 160, 120, 90, 60, 30, 20 and then repeats. • Baby Delicates and Synthetics have a maximum time of 160 . 2. Select any Options if required. 3. Press the Start Button  .	Options available Sound  or Crease care  . Delay Start  . High Heat  .  . Consult suggested drying times (see Laundry). The last few minutes of these programmes is the cool tumble phase.











! For the best performance do not open the door before the cycle has finished.

Programmes Table

! If the On/Off light is not lit; Press the On/Off Button  and then select programme.

Programme	What it does	How to set it	Notes / Options available
 Easy Iron	Brief programme (approximately 10 minutes) that softens fibres of clothing that is ready for ironing.	<ol style="list-style-type: none"> 1. Position the PROGRAMME knob on . 2. Select Alarm Option if required. 3. Press the Start Button . 	! This is not a drying programme (see previous page). Options available Sound  .
 Refresh	20 min cool programme to air your clothes	<ol style="list-style-type: none"> 1. Position the PROGRAMME knob on . 2. Select Alarm Option if required. 3. Press the Start Button . 	Sound  .
 Standard Cotton**	Dries: your Cotton clothes. N.B: Max. load 6 kg (with Low Heat option)	<ol style="list-style-type: none"> 1. Position the PROGRAMME knob on . 2. Choose Sensor Dry  or Timed Dry  (see next page). 3. Select any Options if required. 4. Press the Start Button . 	Sound  or Crease care  . Delay Start  . High Heat  Extra Care  . Sensor Dry option, automatic drying: Damp dry  , Iron dry  , Hanger Plus  , Hanger dry  , Light dry  , Cupboard dry  , Ready to Wear  *
 Shirts	Dries your shirt.	<ol style="list-style-type: none"> 1. Position the PROGRAMME knob on . 2. Choose Sensor Dry  or Timed Dry  (see next page). 3. Select any Options if required. 4. Press the Start Button . 	Sound  or Crease care  . Delay Start  . High Heat  . Sensor Dry option, automatic drying: Damp dry  , Iron dry  , Hanger Plus  , Hanger dry  , Light dry  , Cupboard dry  .
 Jeans	Dries denim clothes.	<ol style="list-style-type: none"> 1. Position the PROGRAMME knob on . 2. Choose Sensor Dry  (see next page). 3. Select any Options if required. 4. Press the Start Button . 	Sound  or Crease care  . Delay Start  . Sensor Dry option, automatic drying: Damp dry  , Iron dry  , Hanger Plus  , Hanger dry  , Light dry  , Cupboard dry  . Ready to Wear  *
 Synthetics	Dries: your synthetics clothes.	<ol style="list-style-type: none"> 1. Position the PROGRAMME knob on . 2. Choose Sensor Dry  or Timed Dry  (see next page). 3. Select any Options if required. 4. Press the Start Button . 	Sound  or Crease care  . Delay Start  . Sensor Dry option, automatic drying: Damp dry  , Iron dry  , Hanger Plus  , Hanger dry  , Light dry  , Cupboard dry  .
 Bed & Bath	Dries your Towels and bedding.	<ol style="list-style-type: none"> 1. Position the PROGRAMME knob on . 2. Choose Sensor Dry  (see next page). 3. Select any Options if required. 4. Press the Start Button . 	Sound  or Crease care  . Delay Start  . Extra Care  . Sensor Dry option, automatic drying: Damp dry  , Iron dry  , Hanger Plus  , Hanger dry  , Light dry  , Cupboard dry  . Ready to Wear  *. (We suggest to use only Cupboard dry).
 Duvet	Dries your Duvet.	<ol style="list-style-type: none"> 1. Position the PROGRAMME knob on . 2. Select any Options if required. 3. Press the Start Button . 	Sound  or Crease care  . Delay Start  . High Heat  .
 Wool	Dries: your Woollen clothes.	<ol style="list-style-type: none"> 1. Position the PROGRAMME knob on . 2. Select any Options if required. 3. Press the Start Button . 	Sound  .
 Silk	Dries your silk items.	<ol style="list-style-type: none"> 1. Position the PROGRAMME knob on . 2. Choose Sensor Dry  (see next page). 3. Select any Options if required. 4. Press the Start Button . 	Sound  . Sensor Dry option, automatic drying: Damp dry  , Iron dry  , Hanger Plus  , Hanger dry  , Light dry  , Cupboard dry  . (We suggest to use only Cupboard dry).
 Baby Delicate	Dries your baby clothes.	<ol style="list-style-type: none"> 1. Position the PROGRAMME knob on . 2. Choose Sensor Dry  or Timed Dry  (see next page). 3. Select any Options if required. 4. Press the Start Button . 	Sound  or Crease care  . Delay Start  . Sensor Dry option, automatic drying: Damp dry  , Iron dry  , Hanger Plus  , Hanger dry  , Light dry  , Cupboard dry  . (We suggest to use only Cupboard dry).
 Anti Allergy	Anti Allergy treatment for your cotton clothes.	<ol style="list-style-type: none"> 1. Position the PROGRAMME knob on . 2. Select any Options if required. 3. Press the Start Button . 	Sound  or Crease care  . Delay Start  .
 Quick Dry	Dries your cotton or synthetic clothes in less time.	<ol style="list-style-type: none"> 1. Position the PROGRAMME knob on . 2. Select any Options if required. 3. Press the Start Button . 	Sound  or Crease care  . Delay Start  . High Heat  .

* just with **High Heat** option on ** This is the most efficient program in terms of energy consumption (EU 392/2012). To reach maximum efficiency, select the CUPBOARD DRY level and the highest temperature option (Standard/Default starting configuration)

Programme	What it does	How to set it	Notes / Options available
 Activewear	Dries your sports clothes.	1. Position the PROGRAMME knob on  . 2. Select any Options if required. 3. Press the Start Button > .	Sound  or Crease care  . Delay Start  .
 Cuddly Toys	Dries your cuddly toy.	1. Position the PROGRAMME knob on  . 2. Select any Options if required. 3. Press the Start Button > .	Sound  . Delay Start  .
 Heat & Enjoy	Heats your towel & bathrobe.	1. Position the PROGRAMME knob on  . 2. Press the Start Button > .	-

The Controls

• Programme knob

! Warning, if after pressing the start button the programme knob position is changed, the new position will **NOT** change the programme selected.

To change programme press Start/Pause Button >|| to pause the programme, the light flashes Amber, select new programme and any option, the light will then flash green. Press the Start/Pause Button >|| and the new programme will start.

• Option Buttons/ Lights

These buttons are used to customise the selected programme to your requirements. Not all options are available for all programmes (see *Start and Programmes*). If an option is not available and you press the button, the buzzer will beep three times. If the option is available there will be one beep and the option light next to the button lights to confirm the selection.

• ECO Light

This light is illuminated when you select programme options that will use less energy than the default setting. Examples are if you choose an Automatic or sensing programme or use a timed dry setting less than the default time. This light does not indicate that the optimum setting for energy use has been selected; it only shows you that your selected options will use less energy.

• Progress Drying, Cool tumble, END) Lights

The Progress lights show you the status of the programme. At each stage of the programme the corresponding light turns on.

• Delay Timer

The start of some programmes (see *Start and Programmes*) can be delayed for up to 24 hours (see The Display).

Ensure the water bottle is emptied and the filter is cleaned before setting a delayed start.

• Extra Care

The Anti-ageing function for Cottons helps to maintain the brightness of your laundry for longer thanks to the use of the right drum rotation (reduced in the last part of cycle) and the correct drying temperature.

Note: It cannot be used with the “Ready to Wear”, “Cupboard Dry” and “Light Dry” dryness levels

• Sound

A buzzer sounds at the end of the drying cycle to signal that the programme has ended and the garments are ready to be removed. If you have selected the Crease Care option, this option is not available.



• Crease Care

When a delayed start and this option have been selected the clothes are tumbled occasionally during the delayed period to help prevent creases developing. After end of the drying and cool tumble cycles, the clothes are

occasionally tumbled to help prevent creases developing, should you not be available to remove the load immediately after the programme is complete. The **END** light is on during this phase after end of the cycle and the start/pause light flashes amber. flashes amber. If you have selected the Sound option, this option is not available.

• High Heat

When a drying time is selected, pressing this button sets a high heat drying and the indicator light above the button lights up.

• **Empty Water Clean Filter Light “h2o”** 
(If you have plumbed your dryer to a drain the  light can be ignored for the water bottle, as there is no need to empty the water container). When  is on (not flashing) it reminds you to empty the water container. If the water container fills during a programme, the heater turns off and the dryer does a period of Cool Tumble then the light flashes and the buzzer sounds. You must empty the container and restart the dryer or the clothes will not dry. After re-starting the dryer the light will take a few seconds to go out. To avoid this always empty the water container each time you use the dryer (see *Maintenance*).

! Please note that you ALWAYS have to clean the filter even if you have plumbed your dryer to a drain.

• Door Opening

Opening the door (or pressing the Start/Pause Button) during a programme will stop the dryer and have the following effects. Note: The Start/Pause Light flashes Amber during the Post Care phase of a programme.

- During a delay phase the delay will continue to count down. The start button must be pressed to resume the delay programme. One of the delay lights will flash to show the current delay setting.
- The start button must be pressed to resume the programme. The progress lights will change to show the current status and the Start/Pause light will stop flashing and turn green.
- During the post creasecare phase of a drying program, the Programme will finish. Pressing the Start/Pause button will restart a new program at the beginning.
 - Changing the Programmes knob will select a new programme and the Start/Pause Light will flash green. You can use this to select the “Refresh” programme to cool the clothes if you find them dry enough. Pressing the start/pause button to begin new Programme.

• Note

If you have a power cut, switch off the power or remove the plug. When power is restored, plug in the machine, press and hold the ON/OFF button until the dryer reactivates, then press Start/Pause button.

One day your dryer seems not to be working. Before you call your Service Centre (see *Service*), go through the following troubleshooting suggestions.

Problem:

The dryer won't start.

Possible causes / Solutions:

- The plug is not plugged into the socket, or not making contact.
- There has been a power failure.
- The fuse has blown. Try to plug another appliance into the socket.
- You are using an extension cord. Try to plug the dryer's power cord directly into the socket.
- The door is not closed securely.
- The programme has not been set properly (see *Start and Programmes*).
- The START button has not been pressed (see *Start and Programmes*).

Drying cycle will not begin.

- You have set a delay time (see *Start and Programmes*).
- You have pressed the start button; there will be a short delay before the dryer starts. Wait for drying to begin, do not press the start button again or the dryer will pause and not begin drying.

It is taking a long time to dry.

- The filter has not been cleaned (see *Maintenance*).
- The water container needs emptying? The empty water light is flashing and "h2o" message is displayed? (see *Maintenance*).
- The condenser needs cleaning (see *Maintenance*).
- The temperature setting is not ideal for the type of fabric you are drying (see *Start and Programmes, and Laundry*).
- The correct drying time has not been selected for this load (see *Laundry*).
- The air intake grille are obstructed (see *Installation and see Maintenance*).
- The items are too wet (see *Laundry*).
- The dryer is overloaded (see *Laundry*).

The Empty water light is flashing but the dryer has only been running for a short period.

- The water container was probably not emptied at the start of the programme. Do not wait for the empty water signal always check and empty the container before starting a new drying programme (see *Maintenance*).

Empty water light is on and the water container is not full.

- This is normal the empty water flashes when the container is full. If the light is on but not flashing its just a reminder to empty the container (see *Start and Programmes*).

Programme finishes and clothes damper than expected.

- ! For safety the dryer has a maximum programme time of 5 hours. If an automatic programme has not sensed the required final moisture in this time the dryer will complete the programme and stop. Check the above points and run the programme again, if the results are still to damp, contact the service centre (see *Service*).

The Display shows a fault code F followed by one or two numbers, the option lights and pause light are flashing.

- If the display shows a Fault, Turn off and remove plug, Clean the Filter and Condenser (see *Maintenance*). Then replace plug turn on and start another program. If the Fault is then displayed contact the service centre (see *Service*). If any other number is shown; Note down the number and contact the service centre (see *Service*).

The display briefly shows "dOn" every 6 seconds.

- The dryer is in 'Demo' mode. Press and hold both the On/Off and Start/Pause buttons for 3 seconds. The display will show "dOn" for 3 seconds and then the dryer will resume normal operation.

Time to End display changes during drying.

- The time to end is continuously monitored throughout the drying cycle and the time is adjusted to give the best-estimated time. The displayed time may increase during the cycle and this is normal.

The dryer makes a thumping noise during the first few minutes of operation.

- This is normal, particularly if the dryer has not been used for a while. If the noise persists throughout the whole drying cycle then contact the service centre.

The lights on the dryer control panel are off although the dryer is switched on.

- The dryer has gone into standby mode to save power. This occurs if you have left the dryer on or have had a power cut. It occurs after 30 minutes:
 - if you leave the dryer without starting a programme;
 - after your drying programme has finished.
 Press and hold the ON/OFF button until the dryer reactivates



Before contacting the Technical Assistance Centre:

- Follow the troubleshooting guide to check whether problems can be solved personally (see *Troubleshooting*).
- If not, switch the dryer off and contact the Technical Assistance Centre closest to you.

Spare parts

This dryer is a complex machine. Attempting to repair it personally or with the aid of an unqualified personnel may put the safety of people at risk, damage the machine or invalidate the spare parts guarantee.
Always contact a qualified technician when experiencing problems with this machine.

Product Guarantee And Repair Information

Guarantee

12 Months Parts and Labour Guarantee

Your appliance has the benefit of our manufacturer's guarantee, which covers the cost of breakdown repairs for twelve months from the date of purchase.

This gives you the reassurance that if, within that time, your appliance is proven to be defective because of either workmanship or materials, we will, at our discretion, either repair or replace the appliance at no cost to you:

This guarantee is subject to the following conditions:

- The appliance has been installed and operated correctly and in accordance with our operating and maintenance instructions.
- The appliance is used only on the electricity or gas supply printed on the rating plate.
- The appliance has been used for normal domestic purposes only.
- The appliance has not been altered, serviced, maintained, dismantled, or otherwise interfered with by any person not authorised by us.
- Any repair work must be undertaken by us or our appointed agent.
- Any parts removed during repair work or any appliance that is replaced become our property.
- The appliance is used in the United Kingdom or Republic of Ireland.

The guarantee does not cover:

- Damage resulting from transportation, improper use, neglect or interference or as a result of improper installation.
- Replacement of any consumable item or accessory. These include but are not limited to: plugs, cables, batteries, light bulbs, fluorescent tubes and starters, covers and filters.
- Replacement of any removable parts made of glass or plastic.

THIS GUARANTEE WILL NOT APPLY IF THE APPLIANCE HAS BEEN USED IN COMMERCIAL OR NON-DOMESTIC PREMISES.

Repairs and After Sales

For product help and advice, repairs, spare parts or accessories, we're here to help.

For local repair engineers - **03448 111 606** ROI - **0818 313 413** UK standard local rate applies ROI local Irish rate applies

For Parts and Accessories visit: parts.hotpoint.co.uk/shop

Please remember to register your appliance at www.hotpointservice.co.uk to activate your 10 year parts guarantee.

Please note, our advisors will require the following information: model number, serial number

This information can be found on the data plate located behind the door.

Information on recycling and disposal

As part of our continual commitment towards environmental protection, we reserve the right to use recycled quality components to reduce costs for our customers and to minimise materials wastage.

- Disposing of the packaging materials: follow local regulations to allow for recycling of packaging materials.
- In order to minimise the risk of injury to children, remove the door and plug, then cut the power supply cord flush with the appliance. Dispose of these parts separately to prevent the appliance from being connected to a power supply socket.

Disposal of old household appliances



European Directive 2012/19/EC concerning Waste Electrical and Electronic Equipment (WEEE) states that household appliances should not be disposed of using the normal solid urban waste cycle. Exhausted appliances should be collected separately in order to optimise the cost of re-using and recycling materials comprising the machine, while preventing potential damage to public health and the environment. The crossed-out wheeled bin symbol appears on all products to remind owners of the obligations regarding separate waste collection.

Owners should contact their local authorities or appliance dealers for further information concerning the correct disposal of household appliances.



This appliance has been designed, constructed and distributed in compliance with the requirements of European Directives:

- LVD 2014/35/EU, EMC 2014/30/EU and RoHS 2011/65/EU.