

# DAILY REFERENCE GUIDE



**THANK YOU FOR BUYING A WHIRLPOOL PRODUCT.**  
For even more complete user support, register your appliance at [www.whirlpool.eu/register](http://www.whirlpool.eu/register)

Please read the content of the *Health & Safety and Installation Guides* thoroughly before you use this appliance.



The transit bolts must be removed before the appliance is used.

See the *Health & Safety and Installation Guides* for detailed instructions on how to remove the transit bolts

## PRODUCT DESCRIPTION

### APPLIANCE

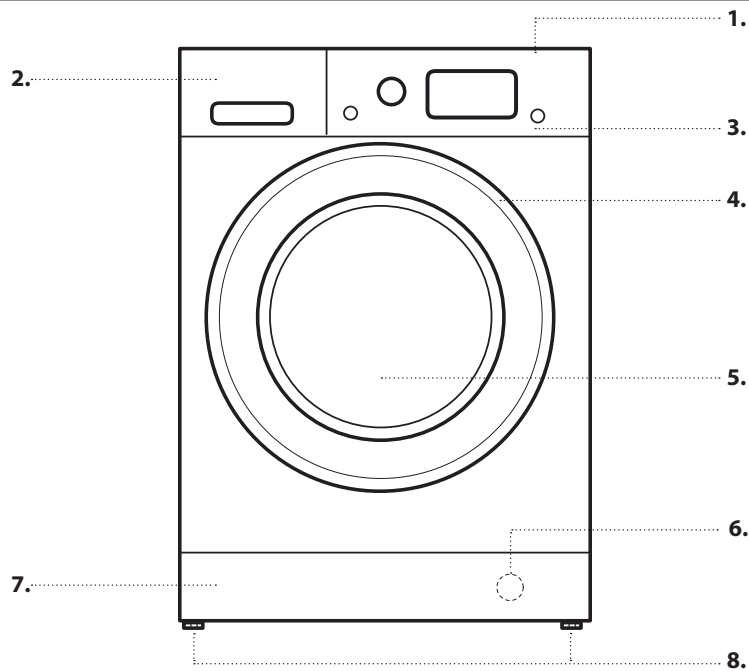

1. Top
2. Detergent dispenser
3. Control Panel
4. Lid handle
5. Door
6. Water filter - behind kick panel
7. Removable kick panel
8. Adjustable feet (2)

### CONTROL PANEL

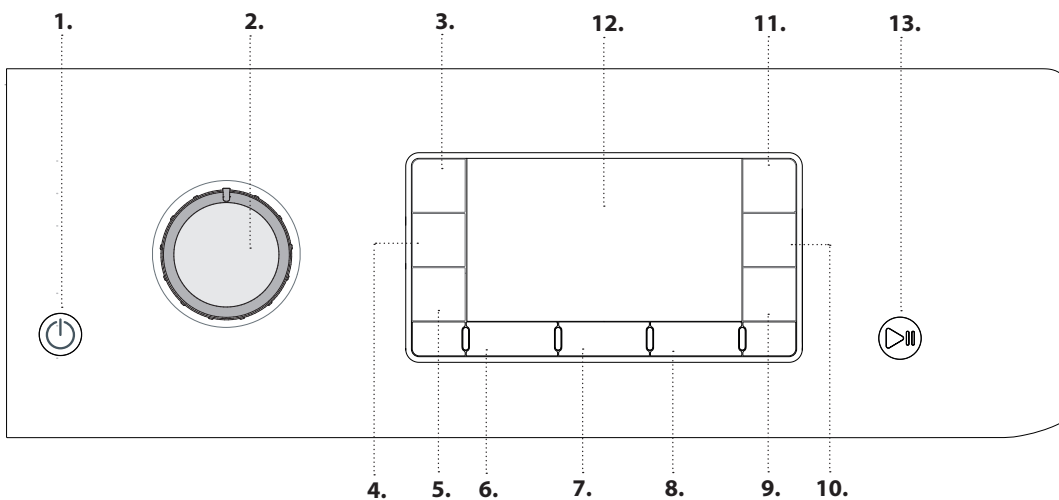

1. On/Off button
2. Programme selector
3. Key Lock button
4. Drying settings button
5. Dry Only Button
6. Temperature button
7. Spin button
8. Delay timer button
9. Rapid button
10. Intensive Rinse button
11. FreshCare+ button
12. Display
13. Start/Pause button

## DETERGENT DISPENSER

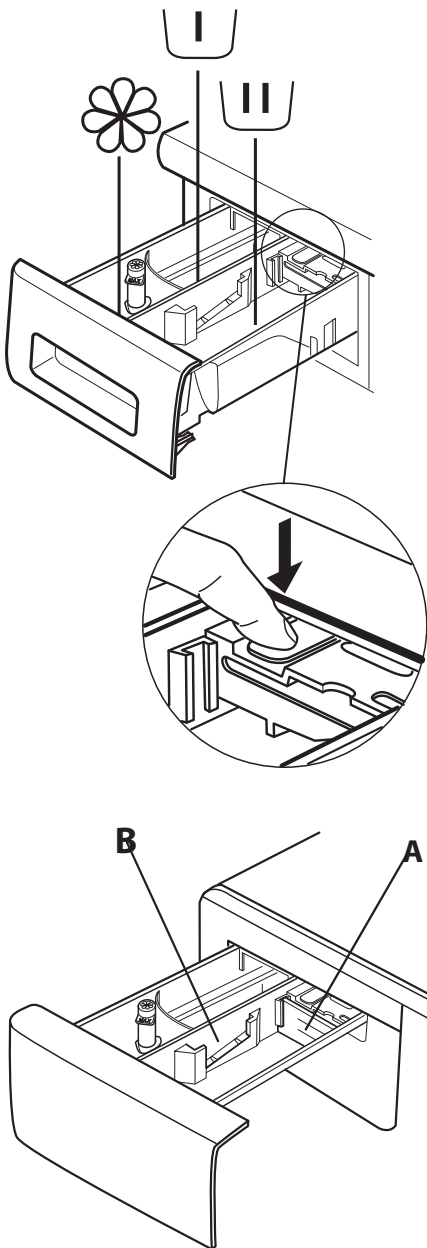

### Prewash Compartment

- Detergent for prewash



### Main Wash Compartment

- Detergent for the main wash
- Stain remover
- Water softener



### Softener compartment

- Softener
- Liquid starch

**Pour softener or starch solution into the compartment without exceeding the "max" level.**

### Release button

(press to remove tray for cleaning).

Preferably use the partition **A** when washing with a liquid detergent for washing, to ensure that the correct quantity of detergent is used (the partition is included in the bag containing the instructions). Move the partition into slot **B** when using detergent powder.

## FIRST TIME USE

See the section *DAILY USE* for instructions on selecting and starting a programme.

The first time the machine is switched on, you will be asked to select the language and the display will automatically show the language selection menu.

To select the desired language press the °C and h buttons; to confirm the selection press the button.

To change the language switch off the machine and press buttons —, , simultaneously until an alarm is heard: the language-selection menu will be displayed again.

To change the display luminosity, which by default is set to the medium value, switch the machine off then simultaneously press buttons —, , and until the buzzer sounds. Press buttons °C and h to choose the desired level of luminosity then confirm by pressing button .

### FIRST CYCLE OPERATION

Remove any manufacturing debris:

1. Select the "**Cotton**" programme with a temperature setting of 60 °C.
2. Pour a small quantity of detergent powder into the main wash compartment of the detergent dispenser (maximum 1/3 of the quantity the detergent manufacturer recommends for lightly soiled laundry).
3. Start the programme **without loading the Washer dryer machine** (with empty drum).



# DAILY USE

## 1. LOADING LAUNDRY.

- Prepare the laundry, following the recommendations given in the section "HINTS AND TIPS". - Open the door and load the laundry into the drum, without exceeding the maximum load capacities indicated in the *Programme Chart*.
- Close the door, pressing until the latch audibly locks, and check that there is no laundry trapped between the door glass and the rubber seal.



## 2. OPEN THE WATER TAP

Check that the Washer dryer is connected correctly to the water mains. Open the water tap.



## 3. SWITCHING ON THE Washer dryer MACHINE.

Press button ; the lamp flashes slowly.

## 4. SELECTING A PROGRAMME AND CUSTOMISING A CYCLE.

The following functions are possible with this appliance:

- Wash only
- Wash and dry
- Dry only

### Wash only

Select the required programme with the PROGRAMME selector dial. The display will show the name and duration of the cycle. The Washer dryer machine automatically displays the maximum temperature and spin speed settings possible for the selected programme. Adjust the temperature and/or spin speed settings if needed with the relative buttons.

- Press button to cycle through progressively lower temperature settings until cold wash is set ("--") shown on display.
- Press button to cycle through progressively lower spin speed settings until the spin cycle is turned off ("--" shown on display).

Pressing the button again sets the highest possible setting.

Select the required options (if necessary).

- Press the button to select the option; the respective button lamp illuminates.
- Press the button again to cancel the option; the lamp extinguishes.

! If the selected option is not compatible with the programme set, an error warning tone sounds and the wording "No Selection" is shown on the display. The option is not selected.

### Wash and dry

To wash and dry a load with no interruption between the wash and dry cycles, make sure that the load does not exceed the maximum permissible drying load for the selected programme (see the column "Max. load for drying cycle" in the *Programme chart*).

1. Follow the instructions given in the paragraph "Wash Only" to select and, if necessary, customise the required programme.
2. Press to select the required drying mode. Two drying modes are available: automatic or timer.

- *Automatic drying with selectable levels:*

In automatic drying mode, the Washer dryer machine dries the laundry until the set level of dryness is reached. Pressing button once automatically selects the highest drying level available for the selected programme. Press the button again to reduce the drying level.

The following levels are available:

Cupboard extra dry : suitable for garments which need to be dried completely, such as sponges and bathrobes.

Cupboard dry : laundry is completely dry and ready to be put away in the wardrobe without ironing.

Hanger dry : laundry is left slightly damp to minimise creasing. Garments must be hung to air dry completely.

Iron dry : garments are left reasonably damp to make ironing easier.

- *Timer drying mode:*

Press button repeatedly to set timer drying mode. After cycling through all the automatic drying levels, continue pressing button until the desired time is displayed. Values from 180 to 30 minutes are settable.

To wash a load of laundry larger than the maximum permissible load for drying (see the column "Max. load for drying cycle" in the *Programme chart*), remove a few garments once the washing cycle has finished before starting the drying cycle. Proceed as follows:

1. Follow the instructions given in the paragraph "Wash Only" to select and, if necessary, customise the required programme.
2. Do not include a drying cycle.
3. Once the washing cycle is finished, open the door and remove a few garments to reduce the load. Now follow the instructions for "Dry only".

N.B.: always allow a cooling down period after drying before opening the door.

When using the two preset cycles "Wash & Dry 45'" and "Wash & Dry 90'", it is not necessary to select and start a drying cycle.

### Dry only

This function is used to simply dry a wet load washed previously in the Washer dryer or by hand.

1. Select a suitable programme for the laundry you want to dry (e.g. select cotton to dry wet cotton laundry).
2. Press button to dry without a wash cycle.
3. Press to select the required drying mode. Two drying modes are available: automatic drying by levels or drying by time.

- *Automatic drying with selectable levels:*

In automatic drying mode, the Washer dryer machine dries the laundry until the set level of dryness is reached. Pressing button once automatically selects the highest drying level available for the selected programme. Press the button again to reduce the drying level.

The following levels are available:



Cupboard extra dry : suitable for garments which need to be dried completely, such as sponges and bathrobes.

Cupboard dry : laundry is completely dry and ready to be put away in the wardrobe without ironing.

Hanger dry : laundry is left slightly damp to minimise creasing. Garments must be hung to air dry completely.

Iron dry : garments are left reasonably damp to make ironing easier.



- *Timer drying mode:*

Press button  repeatedly to set timer drying mode. After cycling through all the automatic drying levels, continue pressing button  until the desired time is displayed. Values from 180 to 30 minutes are settable.  
N.B.: always allow a cooling down period after drying before opening the door.

**5. USING THE CORRECT AMOUNT OF DETERGENT.** Pull out the tray and pour detergent into the relative compartments as described in "*Detergent dispenser*". This is only necessary when using a wash only or a wash + dry programme.

**6. DELAYING THE START OF A PROGRAMME.** To set a programme to start at a later time, see the section "*Options and Functions*".



### **7. STARTING A PROGRAMME.**

Press the START/PAUSE button. The relative indicator lamp illuminates, the door locks and the door open  symbol extinguishes. To change a programme while a cycle is in progress, press START/PAUSE to pause the Washer dryer (the START/ PAUSE lamp flashes amber slowly); then select the required cycle and press START/PAUSE again. To open the door while a cycle is in progress, press START/PAUSE; the door may be opened if the  symbol lights. Press the START/ PAUSE button again to resume the programme from where it was paused.

### **8. CANCELLING A RUNNING PROGRAMME (IF NECESSARY)**

Press and hold the button  until the Washer dryer stops. If the water level and temperature are low enough, the door unlocks and may be opened.  
The door remains locked if there is water in the drum. To unlock the door, switch the Washer dryer on, select the "SPIN & DRAIN" programme and turn the spin function off by setting the spin speed to "- -". The water is emptied and the door unlocks at the end of the programme.

### **9. SWITCHING THE WASHER DRYER OFF AT THE END OF A PROGRAMME.**

At the end of the cycle, the message "Cycle end" is shown on the display. The door can only be opened when the  symbol lights. Check that the door unlocked symbol is lit, then open the door and take out the laundry.  
Press  to switch the Washer dryer off. To save energy, if the Washer dryer is not switched off manually with the  button, it turns off automatically approximately 10 minutes after the end of the programme.  
Leave the door ajar to let the interior of the Washer dryer dry.

# HINTS AND TIPS

## Sort your laundry according to

Type of fabric/care label (cotton, mixed fibres, synthetics, wool, handwash items). Colour (separate coloured and white items, wash new coloured items separately). Delicates (wash small items – like nylon stockings – and items with hooks – like bras – in a cloth bag or pillow case with zip).

## Empty all pockets

Objects like coins or lighters can damage your laundry as well as the drum.

## Follow the dosage recommendation / additives

It optimizes the cleaning result, it avoids irritating residues of surplus detergent in your laundry and it saves money by avoiding waste of surplus detergent

## Use low temperature and longer duration

The most efficient programmes in terms of energy consumption are generally those that perform at lower temperatures and longer duration.

## Observe the load sizes





Load your Washer dryer up to the capacity indicated in the "PROGRAMME CHART" table to save water and energy.

## Noise and remaining moisture content

They are influenced by the spinning speed: the higher the spinning speed in the spinning phase, the higher the noise and the lower the remaining moisture content.

## WASH SYMBOLS ON GARMENT LABELS

The value given in the tub symbol is the maximum temperature possible for washing the garment.

-  Normal mechanical action
-  Reduced mechanical action
-  Much reduced mechanical action
-  Hand wash only
-  Do not wash

## CLEANING & MAINTENANCE

*For any cleaning and maintenance, switch off and unplug the Washer dryer. Do not use flammable fluids to clean the Washer dryer. Clean and maintain your Washer dryer periodically (at least 4 times per year).*

### Cleaning the outside of the Washer dryer

Use a soft damp cloth to clean the outer parts of the Washer dryer. Do not use glass or general purpose cleaners, scouring powder or similar to clean the control panel – these substances might damage the printing

### Checking the water supply hose

Check the inlet hose regularly for brittleness and cracks. If damaged, replace it by a new hose available through our After-Sales Service or your specialist dealer. Depending on the hose type:

If the inlet hose has a transparent coating, periodically check if the colour intensifies locally. If yes, the hose may have a leak and should be replaced.

### Cleaning the water filter / draining residual water

*If you used a hot wash programme, wait until the water has cooled down before draining any water. Clean the water filter regularly, to avoid that the water cannot drain after the wash due to obstruction of the filter.*

Remove the plinth by using the removable plastic partition of the detergent dispenser: push downwards one side of the plinth with your hand, then push the removable plastic partition into the gap between plinth and front panel and pry open the plinth. Place a broad, flat container beneath the water filter, to collect the drain water. Slowly turn the filter counterclockwise until water flows out. Let the water flow out, without removing the filter. When the container is full, close the water filter by turning it in clockwise.

Empty the container. Repeat this procedure until all the water has drained. Lay a cotton cloth beneath the water filter, which can absorb a small amount of rest water. Then remove the water filter by turning it out anti clockwise. Clean the water filter: remove residues in the filter and clean it under running water. Insert the water filter and reinstall the plinth: Reinsert the water filter again by turning it in clockwise direction. Make sure to turn it in as far as it goes; the filter handle must be in vertical position. To test water tightness of the water filter, you can pour about 1 liter of water into the detergent dispenser. Then reinstall the plinth.

### Cleaning the detergent dispenser

Remove the detergent dispenser by pressing on the release button and at the same time pulling out the detergent dispenser. Remove the insert from the detergent dispenser, as well as the insert of the softener compartment. Clean all parts under running water, removing all detergent or softener residues. Wipe the parts dry with a soft cloth. Reinstall the detergent dispenser and push it back into the detergent compartment.

## SAVING ENERGY AND PROTECTING THE ENVIRONMENT

- Keeping within the load limits indicated in the programme chart will optimise energy, water and detergent consumption and reduce washing times.
- Do not exceed the detergent quantities recommended by the detergent manufacturer.
- Save energy by using a 60°C instead of a 90°C wash programme, or by using a 40°C instead of a 60°C wash programme. We recommend using the "Eco 40-60" programme for cotton garments, which is longer but uses less energy.
- To save energy and time when washing and drying, select highest spin speed available for the programme to reduce the residual water remaining in the garments at the end of the wash cycle.

# PROGRAMME CHART

Maximum load 11 kg Power input in off mode 0.5 W / in left-on mode 8 W								Detergents and additives			Recommended detergent		Residual dampness % (***)	Energy consumption kWh	Total water lt	Laundry temperature °C	
Programme	Temperatures		Max. spin speed (rpm)	Drying	Max. load for wash cycle (kg)	Max. load for drying cycle (kg)	Duration (h : m)	Prewash	Main	Softener	Powder	Liquid					
	Setting	Range															
MIXED	40°C	☼ - 40°C	1000	✓	11,0	7,0	**	-	●	○	-	✓	-	-	-	-	-
WHITE (WHITES)	60°C	☼ - 90°C	1600	✓	11,0	7,0	2:40	● (90°)	●	○	✓	-	54	1,90	100	55	
COTTON (2)	40°C	☼ - 60°C	1600	✓	11,0	7,0	3:55	-	●	○	✓	✓	49	1,14	107	45	
ECO 40-60 (1)	40 °C	40°C	1551	✓	11,0	7,0	3:59	-	●	○	✓	✓	44	1,10	62	35	
			1551	✓	5,5		3:00	-	●	○	✓	✓	44	0,85	60	35	
			1551	✓	3		2:15	-	●	○	✓	✓	44	0,60	43	33	
DELICATES	30°C	☼ - 30°C	-	✓	1,0	1,0	**	-	●	○	-	✓	-	-	-	-	-
SYNTHETICS (3)	40 °C	☼ - 60°C	1200	✓	5,5	5,5	2:55	-	●	○	✓	✓	35	0,83	80	43	
DUVET	30°C	☼ - 30°C	1000	-	3,5	-	**	-	●	○	-	✓	-	-	-	-	-
STEAM REFRESH	-	-	-	-	2,0	-	**	-	-	-	-	-	-	-	-	-	-
SPIN & DRAIN *	-	-	1600	✓	11,0	7,0	**	-	-	-	-	-	-	-	-	-	-
RINSE & SPIN	-	-	1600	✓	11,0	7,0	**	-	-	○	-	-	-	-	-	-	-
RAPID 30'	30°C	☼ - 30°C	800	-	5,5	-	0:30	-	●	○	-	✓	71	0,21	50	27	
20°C	20°C	☼ - 20°C	1600	✓	11,0	7,0	1:50	-	●	○	-	✓	55	0,20	95	22	
JEANS	40 °C	☼ - 40°C	800	✓	4,0	4,0	**	-	●	○	-	✓	-	-	-	-	-
WOOL	40 °C	☼ - 40°C	800	✓	2,5	2,5	**	-	●	○	-	✓	-	-	-	-	-
WASH & DRY 45'	30°C	30°C	1600	✓	1,0	1,0	**	-	●	○	-	✓	-	-	-	-	-
WASH & DRY 90'	30°C	30°C	1200	✓	2,0	2,0	**	-	●	○	-	✓	-	-	-	-	-
ECO COTTON (4)	60°C	60°C	1600	✓	11,0	7,0	4:50	-	●	○	✓	✓	44	1,21	70	-	

Selectable/optional      - Not selectable/applicable      ● Required quantity      ○ Optional quantity

The cycle duration indicated on the display or instruction manual is an estimate based on standard conditions. The actual duration may vary in relation to several factors, such as the temperature and pressure of the incoming water, ambient temperature, amount of detergent, load quantity and type, load balancing and any additional options selected. The values given for programmes other than the Eco 40-60 programme are indicative only.

**1) Eco 40-60 (Wash) - Test wash cycle in compliance with EU Ecodesign regulation 2019/2014.** The most efficient programme in terms of energy and water consumption for washing normally soiled cotton laundry.

**Note:** spin speed values shown on the display can slightly differs from the values stated in the table.

**Eco 40-60 (Drying) - Test drying cycle in compliance with EU Ecodesign regulation 2019/2014.** To access "wash and dry" cycle select "Eco 40-60" wash programme and set ☼ option level to . The most efficient programme in terms of energy and water consumption for washing and drying normally soiled cotton laundry. (Cycle duration: full load 9h:50' / half load 6h:00').

**For all testing institutes:**

- Long cotton cycle: set programme COTTON at temperature 40°C.
- Long synthetics cycle: set cycle SYNTHETICS at a temperature of 40°C.

4) **Eco Cotton** - Test wash cycle in compliance with regulations 1061/2010. Set COTTON wash cycle at a temperature of 60°C to access this cycles.

\* Select the SPIN & DRAIN programme and set the spin speed to "--" to empty only.

\*\* The duration of the wash cycles can be checked on the display.

\*\*\* After programme end and spinning with maximum selectable spin speed, in default programme setting.

For wash programmes with temperatures above 50°C, we recommend using powder detergent rather than liquid, and following the directions given on the detergent package.

**6th Sense** - the sensor technology adapts water, energy and programme duration to your wash load.

# PROGRAMMES

Follow the directions indicated in the garment wash symbols.

## MIXED

for washing lightly to normally soiled resilient garments in cotton, linen, synthetic fibres and mixed fibres.

## WHITE

For washing normally to heavily soiled towels, underwear, table and bed linen, etc in resilient cotton and linen. Only when the temperature is selected at 90°C the cycle is provided with a prewash phase before main washing phase. In this case it is recommended to add detergent both, in the prewash and main wash section.

## COTTON

for washing normally to heavily soiled towels, underwear, table and bed linen etc. in resilient cotton and linen.

## ECO 40-60

For washing normally soiled cotton garments declared to be washable at 40 °C or 60 °C, together in the same cycle. This is the standard cotton programme and the most efficient in terms of water and energy consumption.

## DELICATES

for washing particularly delicate garments. Preferably turn garments inside out before washing.

## SYNTHETICS

for washing normally soiled garments made from synthetic fibres (such as polyester, polyacrylic, viscose etc.) or cotton/synthetic blends.

## DUVET

designed for washing eiderdown padded items such as double or single duvets, cushions and anoraks. It is recommended to load such padded items in the drum with the edges folded inwards and not to exceed ¾ of the drum's volume. For optimal washing, we recommend using a liquid detergent.

## STEAM REFRESH

for refreshing garments, neutralised unpleasant odours and relaxing the fibres by delivering steam into the drum. The garments will be damp at the end of the cycle.

## SPIN & DRAIN

spins the load then empties the water. For resilient garments.

## RINSE & SPIN

rinses and then spins. For resilient garments.

## RAPID 30'

for washing lightly soiled garments quickly: this cycle lasts only 30 minutes, saving time and energy. Maximum load 5,5 Kg.

## 20°C

For washing lightly soiled cotton garments, at a temperature of 20 °C.

## JEANS

Turn garments inside-out before washing and use a liquid detergent.

## WOOL

All wool garments can be washed using programme „Wool“ even those carrying the “hand-wash only “ label. For best results, use special detergents and **do not exceed max kg declaration of laundry.**

## WASH & DRY 45'

for washing and drying lightly soiled cotton and synthetic fibre garments quickly. This cycle washes and dries a laundry load of up to 1 Kg in just 45 minutes.

## WASH & DRY 90'

for washing and drying cotton and synthetic fibre garments quickly. This cycle washes and dries a laundry load of up to 2 Kg in just 90 minutes.

## ECO COTTON

For washing normally soiled cotton garments at 60°C.

# OPTIONS AND FUNCTIONS

## OPTIONS selectable directly by pressing the relative button

! If the selected option is not compatible with the programme set, an error warning tone sounds and the wording “No Selection” is shown on the display. The option is not selected.



## FRESHCARE+

If associated with wash cycles, this option increases their performances by generating steam to block proliferation of the main sources of unpleasant odours inside the appliance (exclusively for the wash). After the steam phase, the machine runs a delicate cycle with slow drum rotations. When the FRESHCARE+ option is associated with drying cycles, it prevents stubborn creases from stabilising on garments, thanks to slow drum rotations.

The FreshCare+ cycle starts at the end of the wash or drying cycle and continues for maximum 6 hours; it can be

interrupted at any time by pressing any button on the control panel, or by turning the knob. Wait roughly 5 minutes before opening the door.



## INTENSIVE RINSE

Option makes it possible to select the desired rinse type for sensitive skin. Press the button once for the “Extra +1” level, which makes it possible to select an additional rinse after the standard cycle rinse and remove all traces of detergent. Press the button again for the “Extra +2” level, which makes it possible to select two additional rinses to the standard cycle rinses; it is recommended for very sensitive skin. When the button is pressed for the third time, the “Extra +3” level is set, thus allowing the selection of 3 rinses in addition to the standard cycle's rinses. The option - started with cycles at a temperature of 40°C - makes it possible to remove major allergens such as pollen, cat and dog hair. With cycles at a temperature higher than 40° a very good level of antiallergic protection is achieved. Press the button again to go back to the “Normal rinse” rinse type.

If the current adjustment can be neither set nor changed, the display will show "No Selection" or "No Change".



### **RAPID**

If you select this option, the wash duration will be reduced by up to 50% depending on the selected cycle, thereby guaranteeing simultaneous water and energy saving. Use this cycle for lightly soiled garments.

### **DELAY TIMER**

To set the selected programme to start at a later time, press the button to set the desired delay time. To cancel the delayed start, press the button again until the value "-- h" is shown on the display.

### **LOCK BUTTON**

to lock the control panel, press and hold the button  for approximately 2 seconds. When the display visualises "KEY LOCK ON" the control panel is locked (with the exception of the  button). This prevents unintentional changes to programmes, especially with children near the machine. To unlock the control panel, press and hold the button  for approximately 2 seconds.



You can download the Safety Instructions, Product Fiche and Energy data by:

- Visiting our website - [docs.whirlpool.eu](https://docs.whirlpool.eu)
- Using QR Code
- Alternatively, **contact our After-sales Service** (See phone number in the warranty booklet). When contacting our After-sales Service, please state the codes provided on your product's identification plate.
- For User's Repair & Maintenance Information visit [www.whirlpool.eu](https://www.whirlpool.eu)

The model information can be retrieved using the QR-Code reported in the energy label. The label also includes the model identifier that can be used to consult the portal of the registry at <https://eprel.ec.europa.eu>

