

# Hotpoint

ARISTON



CM 9945 HA



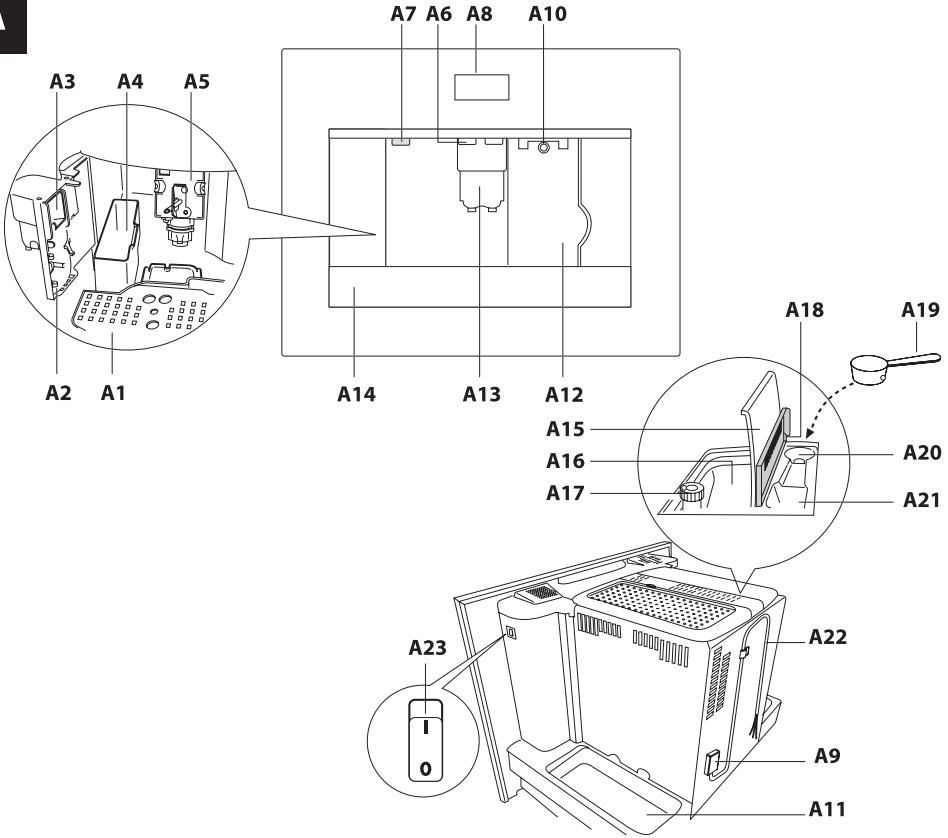
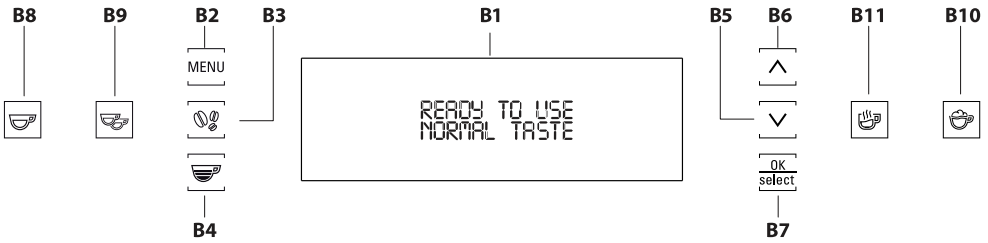
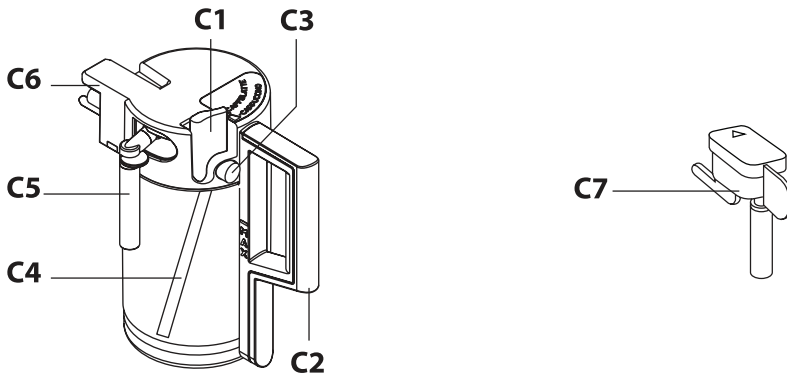

**A****B****C**

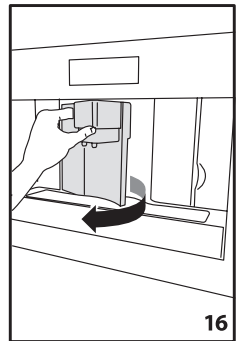
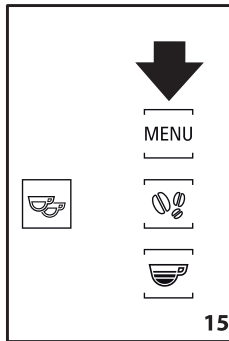
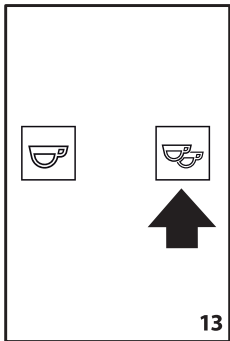
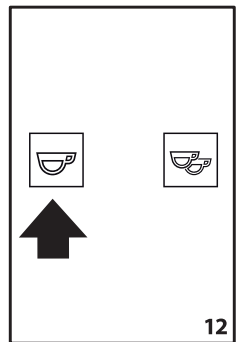
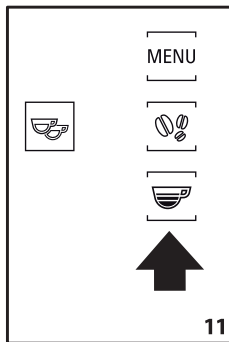
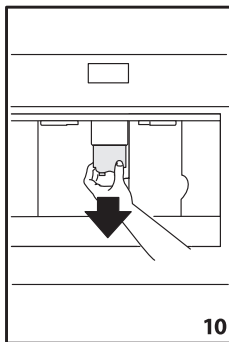
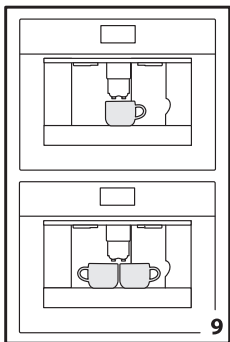
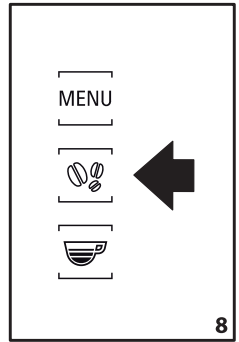
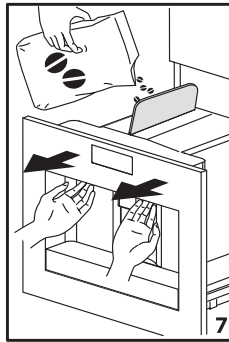
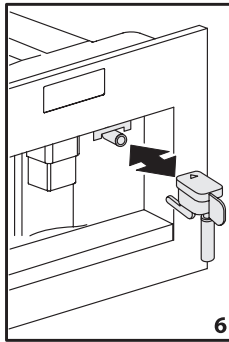
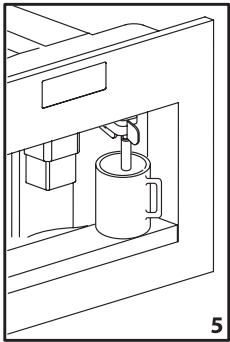
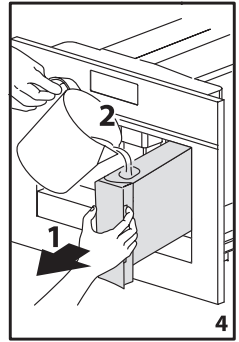
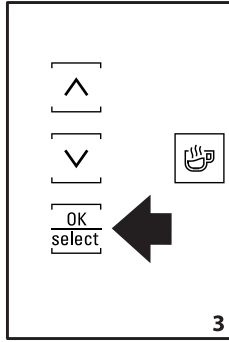
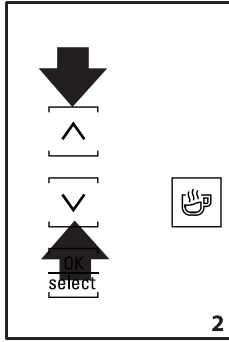
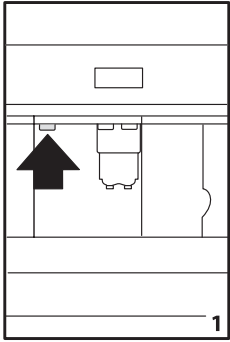

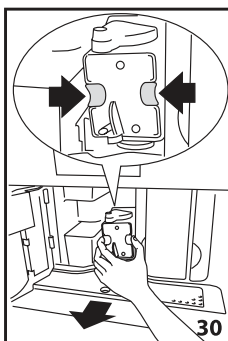
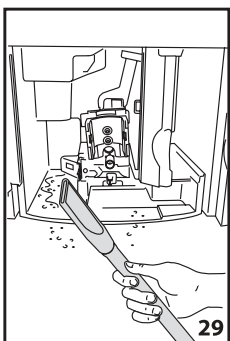
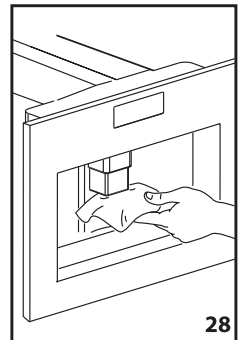
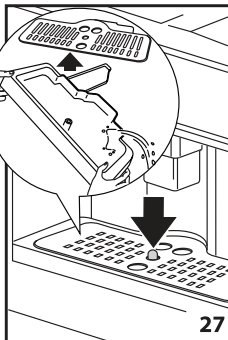
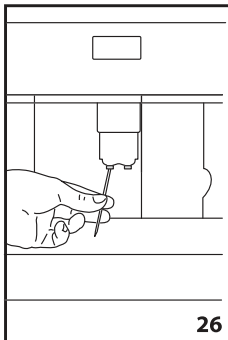
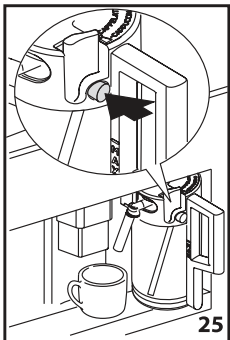
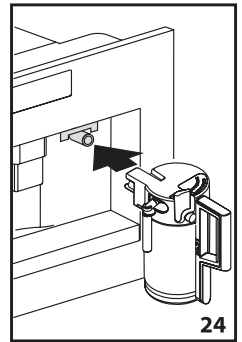
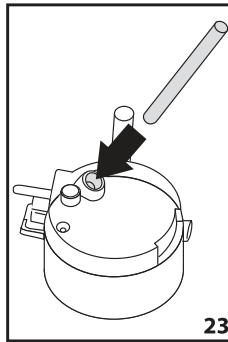
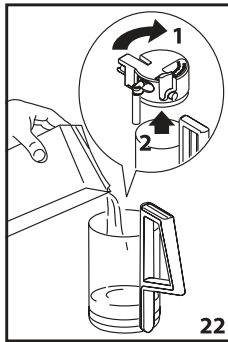
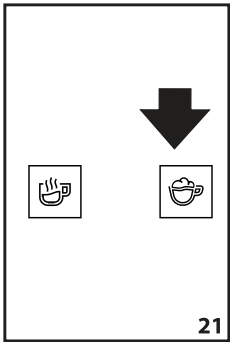
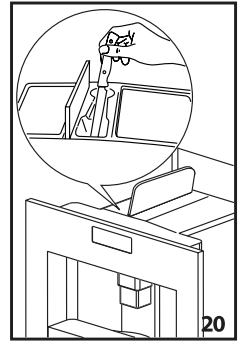
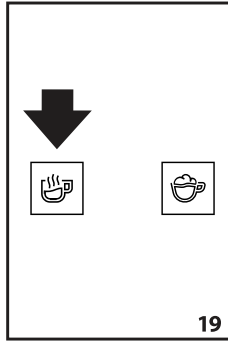
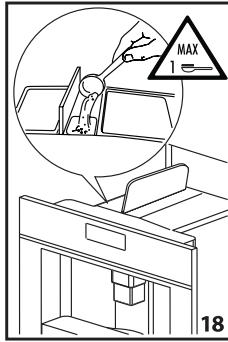
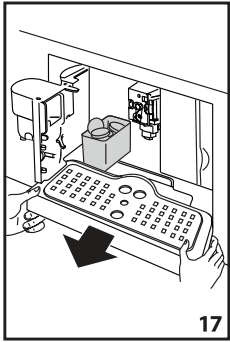

Safety instructions	8
Safeguarding the environment	10
Built-in installation	11
Product description	13
Technical data	13
Using the appliance for the first time	14
Switching on and preheating	14
Making coffee (using coffee beans)	15
Changing the amount of coffee in the cup	16
Adjusting the coffee grinder	16
Making espresso with pre-ground coffee (instead of beans)	16
Running off hot water	17
Making cappuccino	17
Changing the amount of milk and coffee for cappuccino	18
Changing and setting menu parameters	18
Cleaning and maintenance	21
Switching off the appliance	23
Displayed messages	24
Troubleshooting	25

# Safety instructions

## Important to be read and observed

Before using the appliance, read these safety instructions. Keep them nearby for future reference. These instructions are also available on docs.hotpoint.eu.

These instructions and the appliance itself provide important safety warnings, to be observed at all times. The manufacturer declines any liability for failure to observe these safety instructions, for inappropriate use of the appliance or incorrect setting of controls.

## Safety warnings

Very young children (0-3 years) should be kept away from the appliance. Young children (3-8 years) should be kept away from the appliance unless continuously supervised. Children from 8 years old and above and persons with reduced physical, sensory or mental capabilities or lack of experience and knowledge can use this appliance only if they are supervised or have been given instructions on safe use and understand the hazards involved. Children must not play with the appliance.

Cleaning and user maintenance must not be carried out by children without supervision. Intended use: this appliance is designed to prepare coffee, milk based beverages and hot water. Any other use is considered improper and thus dangerous. The manufacturer is not liable for damages deriving from improper use of the appliance. The heating element surface is subject to residual heat after use and the outside of the appliance may retain heat for several minutes depending on use. To clean the appliance follow the instructions provided in section "Cleaning". Cleaning and user maintenance shall not be made by children unless they are above 8 years old and supervised. Keep the appliance and power cord away from children under 8 years of age.

**WARNING:** Accessible parts may become hot during use, young children should be kept away.

The appliance produce hot water. Take care to avoid contact with splashes - Risk of burns.

If the appliance is damage or not working properly, do not attempt to carry out any repairs.

Switch the appliance off, unplug from power supply and contact After-sales Service.



Surfaces marked with this symbol become hot during use (the symbol is present in certain models only).

**WARNING:** Models with glass surfaces: do not use the appliance if the surface is cracked.



## **Permitted use**

**CAUTION:** the appliance is not intended to be operated by means of an external timer or separate remote controlled system.

This appliance is intended to be used only in household application.

This appliance is Not intended to be used in similar application such as: staff kitchen areas in shops, offices and other working environments; farm houses; by clients in hotels, motels, bed & breakfast and other residential environments.

This appliance is not for professional use. Do not use the appliance outdoors. Do not store explosive or flammable substances (e.g. gasoline or aerosol cans) inside or near the appliance - risk of fire.

## **Installation**

The appliance must be handled and installed by two or more persons - risk of injury. Use protective gloves to unpack and install - risk of cuts. Installation, including water supply (if any) and electrical connections, and repairs must be carried out by a qualified technician. Do not repair or replace any part of the appliance unless specifically stated in the user manual. Keep children away from the installation site.

After unpacking the appliance, make sure that it has not been damaged during transport. In the event of problems, contact the dealer or your nearest After-sales Service. Once installed, packaging waste (plastic, styrofoam parts etc.) must be stored out of reach of children - risk of suffocation. The appliance must be disconnected from the power supply before any installation operation - risk of electrical shock. During installation, make sure the appliance does not damage the power cable - risk of fire or electrical shock. Only activate the appliance when the installation has been completed.

The appliance can be installed above a built-in oven only if the latter is equipped with a cooling fan system.

## **Electrical warnings**

Prior to connect the appliance verify that the voltage on the rating plate corresponds to the voltage in your home.

It must be possible to disconnect the appliance from the power supply by unplugging it if plug is accessible, or by a multi-pole switch installed upstream of the socket and the appliance must be earthed, in conformity with national electrical safety standards.

Do not use extension leads, multiple sockets or adapters. The electrical components must not be accessible to the user after installation. Do not use the appliance when you are wet or barefoot. Do not operate this appliance if it has a damaged power cable or plug, if it is not working properly, or if it has been damaged or dropped. If the power cable is

damaged, it must be replaced with an identical one - risk of electrical shock. If the power cable needs to be replaced, contact an authorised service center. Appliances with removable cord: avoid splashes of water on the power cord connector or socket at the back of the appliance.

**WARNING:** Avoid any spillage on the connector and plug.

## **Cleaning and maintenance**

**WARNING:** Ensure that the appliance is switched off and disconnected from the power supply before performing any maintenance operation. To avoid risk of personal injury use protective gloves (risk of laceration) and safety shoes (risk of contusion); be sure to handle by two persons (reduce load); never use steam cleaning equipment (risk of electric shock).

Non-professional repairs not authorised by the manufacturer could result in a risk to health and safety, for which the manufacturer cannot be held liable. Any defect or damage caused from non-professional repairs or maintenance will not be covered by the guarantee, the terms of which are outlined in the document delivered with the unit.

Never immerse the appliance in water.

Empty regularly the drip tray to avoid overflow - Risk of injury.

Clean all the components thoroughly, taking particular care with parts in contact with the coffee and milk.

Always clean tubes inside milk container after use - Risk of poisoning.

During rinsing, hot water is spilled from the coffee spouts. Avoid contact with splashes of water - Risk of burns.

## **Safeguarding the environment**

### **Disposal of packaging materials**

The packaging material is 100% recyclable and is marked with the recycle symbol (). The various parts of the packaging must therefore be disposed of responsibly and in full compliance with local authority regulations governing waste disposal.

### **Scrapping of household appliances**

This appliance is manufactured with recyclable or reusable materials. Dispose of it in accordance with local waste disposal regulations. For further information on the treatment, recovery and recycling of household electrical appliances, contact your local authority, the collection service for household waste or the store where you purchased the appliance. This appliance is marked in compliance with European Directive 2012/19/EU, Waste Electrical and Electronic Equipment (WEEE) and with the Waste Electrical and Electronic Equipment regulations 2013 (as amended). By ensuring this product is disposed of correctly, you will help prevent negative consequences for the environment and human health.

The () symbol on the product or on the accompanying documentation indicates that it should not be treated as domestic waste but must be taken to an appropriate collection center for the recycling of electrical and electronic equipment.

### **Declaration of conformity CE**

This appliance has been designed, constructed and distributed in compliance with the requirements of European Directives: LVD 2014/35/EU, EMC 2014/30/EU and RoHS 2011/65/EU.

This appliance, which is intended to come into contact with foodstuffs, complies with European Regulation ()

# Built-in installation

Check the minimum measurements required for correct installation of the appliance. The coffee machine must be installed in a column unit, which must in turn be securely fixed to the wall by means of commercial brackets.

### Attention:

- Disconnect the appliance from the mains before carrying out any installation work or servicing.
- Kitchen units in contact with the appliance must be heat resistant (min. 65°C).
- To ensure adequate ventilation, provide an opening on the bottom of the housing (see dimensions in Figure).

### Dimensions in mm

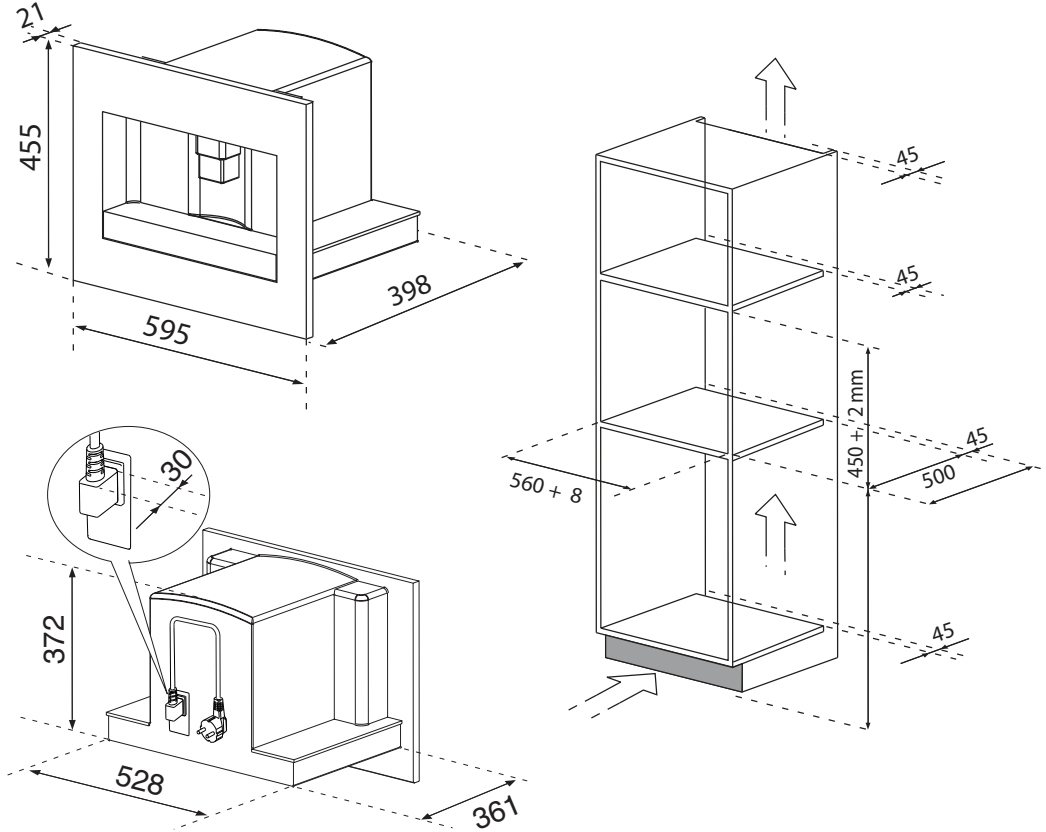

Position the runners on the sides of the housing, as shown in the Figure. Secure the runners with the screws supplied, then pull them out to full extension. If the coffee machine is installed above a "warmer drawer", use the top of the latter as a reference for positioning the runners. In this case, there will be no support surface.

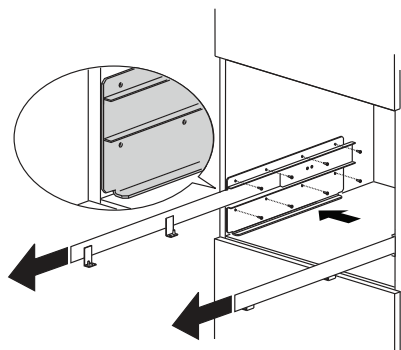

Secure the power supply cable with the clip provided. The power supply cable must be long enough to allow the machine to be removed from the housing in order to fill the coffee bean container. **Regulations require that the appliance is earthed. Electrical connection must be carried out by a qualified electrician in accordance with the manufacturer's instructions.**

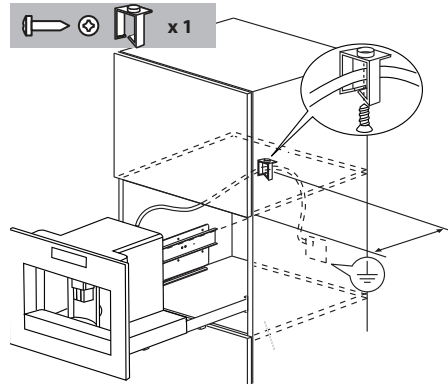

Position the machine on the runners, making sure that the pins engage properly in their seats before securing with the screws provided.

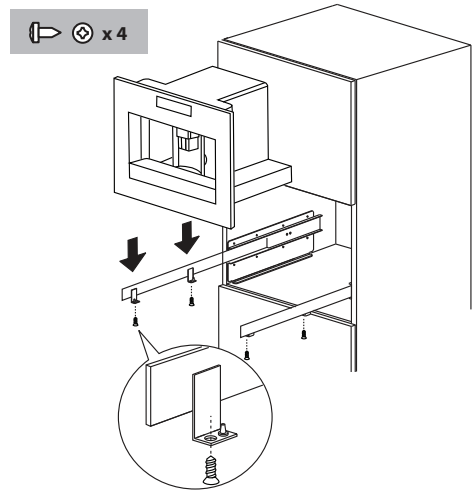

If machine alignment requires adjustment, position the spacers provided either below or at the side of the support.

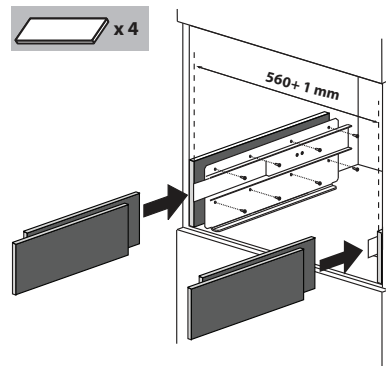

## Product description

### Appliance











See image **A** on page 4.

- A1** Cup tray
- A2** Service door
- A3** Coffee feed
- A4** Coffee grounds container
- A5** Brewing unit
- A6** Cup tray lights
- A7** On/stand-by button
- A8** Control panel
- A9** IEC Connector
- A10** Hot water and steam nozzle
- A11** Storage tray
- A12** Water tank
- A13** Coffee spout (height-adjustable)
- A14** Drip tray
- A15** Lid of coffee bean container
- A16** Coffee bean container
- A17** Grinding coarseness adjustment knob
- A18** Ground coffee funnel cap
- A19** Scoop
- A20** Scoop compartment
- A21** Ground coffee feed funnel
- A22** Power supply cable
- A23** Main **ON/OFF** switch

### Control panel

See image **B** on page 4.

**N.B.:** the touch-control buttons are activated at the lightest touch of a finger.

- B1** Display: guides the user through use of the machine.
- B2** **MENU** Button  to activate or deactivate the menu setting mode.
- B3** Button  for selecting the coffee taste.
- B4** Button  for selecting the type of coffee desired (espresso, small cup, medium cup, large cup, mug)
- B5-B6** Buttons   for browsing through the various menu entries.
- B7** Button  to confirm the selection
- B8** Button  to prepare one cup of coffee
- B9** Button  to prepare two cups of coffee
- B10** Button  to prepare a cappuccino.
- B11** Button  to dispense hot water.

### Milk and accessories container





See image **C** on page 4.

- C1** Milk frother pointer
- C2** Milk container handle
- C3** **CLEAN** button
- C4** Milk intake tube
- C5** Frothed milk spout
- C6** Milk frother
- C7** Hot water spout

## Technical data

Voltage	220-240 V~ 50/60 Hz max. 10A
Absorbed power:	1350W
Pressure:	15 bar
Water tank capacity:	1.8 litres
Size (L x H x W):	595 x 455 x 398 mm
Weight:	26 kg

## Using the appliance for the first time

- Coffee has been used to factory test the machine and it is therefore completely normal for there to be traces of coffee in the mill.
  - Customize water hardness as soon as possible, following the instructions in paragraph *Setting water hardness*.
1. Connect the appliance to the mains electricity supply and place the main switch (A23) in position I.
  2. The appliance displays “fill tank” in different languages. Extract the water tank (fig. 4), rinse and fill with fresh water without exceeding the MAX line. Replace and push as far as it will go.
  3. Choose the language (the languages scroll through at intervals of about 3 seconds): When the message “press  to TO INSTALL ENGLISH” is displayed, press the  (B7) (fig. 3) for 3 seconds until **ENGLISH INSTALLED** is displayed. If you set the wrong language, follow the instructions in the “Setting the language” section. If your language is not available, select one from those displayed (the instructions refer to English). Then follow the instructions displayed.
  4. Place a cup under the hot water spout (fig. 5). (If the hot water spout is not inserted, the appliance displays **INSERT WATER SPOUT!** Attach the spout as shown in figure 6. The machine displays **HOT WATER PRESS **”. Press the  (B7), a little water comes out of the spout.
  5. The display shows **TURNING OFF. PLEASE WAIT...** and switches off.
  6. Slide the machine out, using the handles provided (Figure 7); open the lid, fill the coffee bean container, then close the lid and push the machine back into the housing.

The coffee machine is now ready for normal use.



### **WARNING:**

**Never place pre-ground coffee, freeze-dried coffee, caramelized coffee or foreign objects in the container, as they could damage the machine**

### **N.B.:**

- When using the appliance for the first time, you need to make 4/5 cups of coffee and 4/5 cappuccinos before the appliance gives good results.
- Each time the machine is turned on using the main **ON/OFF** switch (A23) it runs the **SELF-DIAGNOSIS** function and then switches off: to switch back on again, press the (A7) on/stand-by button (Figure 1).

## Switching on and preheating

Each time the machine is switched on, it performs an automatic preheat and rinse cycle which cannot be interrupted. The machine is ready for use only after completion of this cycle







### **WARNING:**

**Risk of burns! During rinsing, some hot water is run off from the coffee spouts.**

To switch the appliance on, press the (A7) on/stand-by button (Figure 1): the display shows **HEATING UP. PLEASE WAIT....** After heating, the display shows another message: **RINSING**. The machine is at working temperature when the display shows **MEDIUM CUP STANDARD TASTE**.





## Making coffee (using coffee beans)

1. The machine is factory-set to make coffee with a standard taste. You can choose coffee with the following tastes: extra-mild, mild, standard, strong or extra-strong, with the option of using pre-ground coffee. To choose the desired taste, press the button  (B3) (Figure 8) repeatedly until the required taste is displayed.
2. Place 1 cup under the coffee spouts if you wish to make 1 coffee (Figure 9) or 2 cups for 2 coffees (Figure 9). For a creamier coffee, lower the coffee spout as near as possible to the cups (Figure 10).
3. Press button  (B4) (Figure 11) to select the type of coffee desired: espresso, small cup, medium cup, large cup, mug.  
Press button  (B8) (Figure 12) to make 1 coffee, or button  (B9) (Figure 13) to make 2 coffees.  
The machine grinds the coffee beans and then runs off the coffee.  
After running off the pre-set quantity of coffee, the machine automatically stops run-off and then empties the coffee grounds into the grounds container.
4. After a few seconds, the machine is once again ready for use.
5. To switch off the machine, press the on/stand-by button (A7) (Figure 1). (Before switching off, the machine runs an automatic rinse cycle: beware of the danger of burns).

### N.B.:

- If coffee run-off is too slow or incomplete, refer to chapter *ADJUSTING THE COFFEE GRINDER*.
- If coffee run-off is too quick and the coffee is not creamy enough, refer to chapter *ADJUSTING THE COFFEE GRINDER*.
- Tips for hotter coffee:
  - proceed as described in chapter *CHANGING AND SETTING MENU PARAMETERS*, function Rinsing;
  - do not use very thick cups as they absorb too much heat unless pre-heated in advance;
  - use pre-heated cups, rinsing them with hot water.
- You can interrupt run-off any time by pressing the previously selected button again.
- As soon as run-off is finished, to increase the amount of coffee in the cup, simply press and hold the previously selected button within 3 seconds of completion of run-off).
- When the display shows **FILL TANK!** the water tank must be filled, otherwise the machine will not prepare any coffee. (The tank may still contain some water; this is normal).
- Every 14 single coffees (or 7 doubles) made, the display shows the message **EMPTY GROUNDS CONTAINER!**. To clean, open the service door on the front by pulling the spout (Figure 16), then remove the drip tray (Figure 17) and clean it.

When cleaning the machine, **always fully remove the drip tray.**

- **When removing the drip tray, the grounds container MUST be emptied. If this is not done, the machine may clog up.**
- The water tank must never be pulled out during coffee run-off. If the tank is removed at this point, the machine cannot make the coffee and will display the message: **GROUND TOO FINE ADJUST MILL! PRESS**  followed by **FILL TANK!**. Check the water level in the tank and replace in the machine. To restart the machine, insert the water spout if not already inserted (Figure 6), press  (B7) and the display shows **HOT WATER. PRESS** . Press  (B7) within a few seconds, let water run off from the spout for around 30 seconds. After run-off, the machine display automatically reverts to the programmed standard settings.
- The machine may require you to repeat the operation several times; this is in order to eliminate any air in the hydraulic circuit.
- If the above described operation is not carried out correctly or if the machine is switched off, the display may revert to showing the programmed standard settings, even if in actual fact the problem persists.

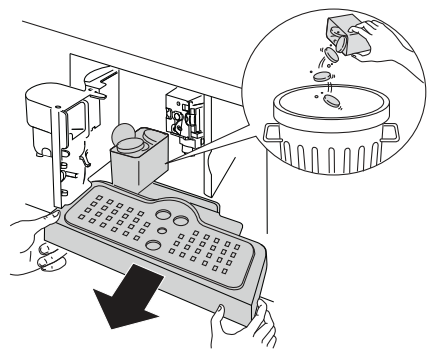



## Changing the amount of coffee in the cup

The appliance is factory-set to automatically deliver the following amounts of coffee:



- Espresso,
- Small cup,
- Medium cup,
- Large cup,
- Mug.

To modify these quantities and set the amount of coffee desired, for example changing the amount of espresso, proceed as follows:

- Press the button  (B4) repeatedly until the display shows **ESPRESSO**.
- Keep the button  (B8) pressed until the display shows the message **PROGRAM QUANTITY**. Meantime the machines runs off coffee.
- Press the button  (B8) again to stop run-off and reprogram the machine with the new quantity of coffee.

The machine is now reprogrammed with the new setting and is ready for use.

You can also modify the amount of coffee in a small cup, medium cup, large cup and mug.

**N.B.:** press button  (B9) for a measure of coffee which is double that previously set using button  (B8). If you wish to return to the original machine settings, see paragraph *Resetting factory default values (reset)*.

## Adjusting the coffee grinder

The coffee grinder is factory-set and does not require adjustment; nonetheless, if run-off is too fast or too slow (coffee drips out), carry out an adjustment using the grinding coarseness adjustment knob (Figure 14).

### **WARNING:**

**The adjustment knob must only be turned while the grinder is in operation.**

For slower run-off and creamier coffee, turn the knob 1 click in an anti-clockwise direction (= finer ground coffee).

For faster run-off (not in drips), turn the knob 1 click in a clockwise direction (= coarser ground coffee).

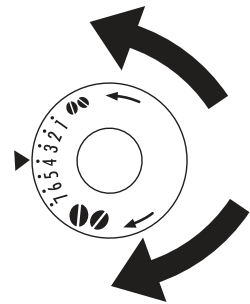

## Making espresso with pre-ground coffee (instead of beans)

- Press button  (B3) (Figure 8) and select the pre-ground coffee function.
- Slide the machine out towards you; be sure to use the purpose-designed handles (Figure 7).
- Lift the small central lid, pour one scoop of pre-ground coffee into the funnel (Figure 18); push the machine back inside the housing and proceed as described in chapter *MAKING COFFEE (USING COFFEE BEANS)*.

**N.B.:** only one coffee at a time can be made, press button  (B8) (Figure 12).



- If, after operating the machine with pre-ground coffee, you want to revert to making coffee with beans again, deactivate the pre-ground coffee function by pressing button  (B3) (Figure 8) again.

### **N.B.:**

- Never add pre-ground coffee when the machine is switched off, as it could spread throughout the inside.
- Never add more than 1 scoop, otherwise the machine will not prepare the coffee.
- Use only the scoop provided.
- Only use pre-ground coffee for espresso coffee machines.
- If you add more than one scoop of ground coffee and the funnel becomes blocked, carefully use a knife to clear the coffee through the funnel (Figure 20), then remove and clean the brewing unit and the machine as described in paragraph *Cleaning the brewing unit*.



## Running off hot water

- Always check that the machine is ready for use.
- Check that the water spout is attached to the nozzle (Figure 6).
- Place a container under the spout.
- Press button  (B11) the display will show **HOT WATER PRESS**  , press  (B7) to confirm.

The display shows **HOT WATER** and hot water runs out of the spout, filling the container below (Do not run off hot water for more than 2 minutes at a time). To stop the flow, press the button  (B11). Run-off stops automatically when the pre-set quantity of water has been dispensed.

## Making cappuccino

- Select the taste of coffee you wish to use for making the cappuccino, pressing the button  (B3).
- Remove the milk container lid.
- Fill the container with approximately 100 ml of milk for each cappuccino you want to make (Figure 22), without exceeding the **MAX** line (equivalent to 750ml approx.) on the container. Ideally, use skimmed or semi-skimmed milk at refrigerator temperature (about 5°C).
- Make sure the milk intake tube is properly inserted in the rubber washer (Figure 23), then replace the milk container lid.
- Position the milk frother pointer (C1) between the words **CAPPUCCINO** and **CAFFELATTE** printed on the milk container lid. The quantity of froth produced can be adjusted: move the pointer towards the word **CAFFELATTE** for a lighter froth. Moving the pointer, on the other hand, towards **CAPPUCCINO** gives a thicker froth.

- A. NO froth
- B. Lighter froth
- C. Pointer
- D. Thicker froth

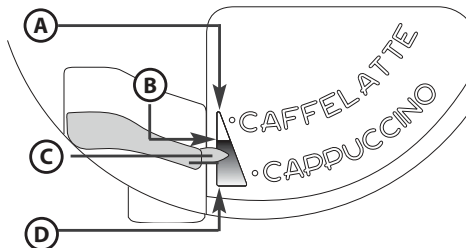



- Remove the hot water spout (Figure 6) and attach the milk container to the nozzle (Figure 24).
- Move the milk spout as described above and place a sufficiently large cup under the coffee spout and the milk spout.
- Press the button  (B10). The message **CAPPUCCINO** is displayed and a few seconds later, frothed milk runs out of the milk spout and fills the cup below. (Run-off of milk stops automatically and coffee run-off begins).
- The cappuccino is now ready: add sugar to taste and, if you like, dust the froth with powdered cocoa.

**N.B.:**

- While making cappuccino, you can stop frothed milk or coffee run-off by pressing the button  (B10).
- To keep the milk frother hygienically clean at all times, always clean the internal tubes of the milk container lid after making cappuccino. The message **PRESS CLEAN BUTTON** is displayed:
  - **place a container under the milk spout (Figure 25);**
  - press and hold the **CLEAN** button (C3) on the milk container lid for at least 8 seconds, (Figure 25) to activate cleaning. The message **CLEANING...** is displayed with a progress bar below. Do not release the **CLEAN** button until the bar is complete and cleaning has ended. The cleaning cycle stops when the **CLEAN** button is released. After cleaning, remove the milk container and place it in the refrigerator. It is best not to leave milk out of the refrigerator for longer than 15 minutes.
- If you want to modify the amount of coffee or frothed milk automatically run off into cups by the machine, proceed as described in chapter *CHANGING THE AMOUNT OF MILK AND COFFEE FOR CAPPUCCINO*.

## Changing the amount of milk and coffee for cappuccino

The appliance is factory-set to automatically deliver a standard cappuccino. To modify these quantities, proceed as follows:

- Fill the milk container up to the maximum level indicated on the container itself.
- Keep the button  (B10) pressed until the display shows the message **PROGRAM QUANTITY MILK FOR CAPPUCCINO**. Meantime the machine runs off milk.
- Press the button  (B10) again to stop run-off and reprogram the machine with the new quantity of milk.
- After a few seconds, coffee begins running out and the display shows the message **PROGRAM QUANTITY COFFEE FOR CAPPUCC**.
- Press the button  (B10) again to stop run-off and reprogram the machine with the new quantity of coffee.

The machine is now reprogrammed with the new setting and is ready for use.









## Changing and setting menu parametrs

When the machine is ready for use, you can access the menu in order to change the following parameters or functions:

- RINSING
- SETTING THE CLOCK
- LANGUAGE
- AUTO START
- DESCALING
- COFFEE TEMPERATURE
- AUTO OFF
- WATER HARDNESS
- RESET TO DEFAULT
- ENERGY SAVING
- STATISTICS
- SETTING THE TONE
- EXIT





## Setting the language

To change the display language, proceed as follows:

- Press the **MENU** button  (B2) to access the menu and then buttons   (B5) and (B6) to select **LANGUAGE**.
- Press  (B7).
- Press buttons   (B5) and (B6) until the required language is displayed.
- Press  (B7) to confirm.
- Press the **MENU** button  (B2) to exit the menu.









## Rinsing

This function is used to obtain hotter coffee. Proceed as follows:











- If, when you turn the machine on, you select a small cup of coffee (less than 60ml), use the hot water from the rinse cycle to pre-heat the cup.
- If, on the other hand, more than 2/3 minutes have elapsed since the last coffee was made, pre-heat the brewing unit before making any more coffee. To do so, press the **MENU** button  (B2) to access the menu; the display shows the message **RINSING**. Press  (B7). The display shows  **TO CONFIRM**. Press the button  (B7) again. Let the water run into the drip tray below or use it to fill (and then empty) the cup to be used for coffee, thus warming it.

## Changing the duration of operation

The appliance is factory-set to switch off automatically after 30 minutes of inactivity. To change this time (max 120 min.), proceed as follows:













- Press the **MENU** button  (B2) to access the menu and then buttons   (B5) and (B6) until the display shows the message **AUTO-OFF**.
- Press  (B7) to confirm.
- Press buttons   (B5) and (B6) to set the period of time after which the appliance must switch off (30 minutes, 1 hour, 2 hours).
- Press  (B7) to confirm.
- Press the **MENU** button  (B2) to exit the menu.

## Setting the clock

- Press the **MENU** button  (B2) to access the menu and then buttons   (B5) and (B6) until the display shows the message **ADJUST TIME**.
- Press  (B7).
- To set the hours, use buttons   (B5) and (B6) then press  (B7) to confirm.
- To set the minutes, use buttons   (B5) and (B6) and then press  (B7) to confirm.
- Press the **MENU** button  (B2) to exit the menu.









## Setting automatic start time

This function allows you to set the machine to switch on automatically at a time of your choosing.

- Make sure the appliance clock has been set.
- Press the **MENU** button  (B2) to access the menu and then buttons   (B5) and (B6) until the display shows the message **AUTO-START**.
- Press  (B7).
- The machine displays the message **AUTO-START ENABLE?**
- Press  (B7) to confirm.
- To set the auto start time, use the buttons   (B5) and (B6) then press  (B7) to confirm.
- To set the minutes, use buttons   (B5) and (B6) and then press  (B7) to confirm.
- Press  (B7), the display shows **AUTO-START ENABLED**.









## Changing the coffee temperature

To change the temperature of coffee run off, proceed as follows:

- Press the **MENU** button  (B2) to access the menu and then buttons   (B5) and (B6) until the display shows the message **COFFEE TEMPERATURE**;
- Press  (B7).
- Press buttons   (B5) and (B6) to select the required coffee temperature: low, medium, high.
- Press  (B7) to confirm the temperature chosen.
- Press the **MENU** button  (B2) to exit the menu.

## Setting water hardness

If desired, the interval between descaling cycles can be increased so that descaling is performed less frequently and in accordance with the actual calcium content of the water used. Proceed as follows:

- Remove the "Total hardness test" water hardness strip from its packaging (attached to page 2), immerse it fully in the water for a few seconds. Next, remove it and wait around 30 seconds (until it changes colour and red squares appear on the strip).
- Press the **MENU** button  (**B2**) to access the menu and then buttons   (**B5**) and (**B6**) until the display shows the message **WATER HARDNESS**.
- Press  (**B7**).
- Press buttons   (**B5**) and (**B6**) to select the number of dots corresponding to the number of red squares which have formed on the test strip (for example, if the test strip shows 3 red squares, you need to select the message ●●●○);
- Press  (**B7**) to confirm. The machine is now set to carry out descaling when it is actually necessary.
- Press the **MENU** button  (**B2**) to exit the menu.

## Descaling















### **WARNING:**

**Descaler contains acids. Observe the manufacturer's safety warnings given on the descaler pack.**

**N.B.:** Only use descalers recommended by the manufacturer. Failure to do so invalidates the machine warranty. Failure to descale the machine regularly will also invalidate the warranty.

When the display shows the message **DESCALE!**, it is time to descale the machine. Proceed as follows:







- Make sure that the machine is ready for use.
- Attach the water spout (**C7**) to the nozzle (**A10**).
- Press the **MENU** button  (**B2**) to access the menu and then buttons   (**B5**) and (**B6**) until the display shows the message **DESCALING**.
- Press  (**B7**), the display shows the message **DESCALING**.  **TO CONFIRM.**
- Press  (**B7**), the display shows the message **ADD DESCALER. PRESS** .
- Empty the water tank, pour in the contents of the bottle of descaler, taking care to observe the manufacturer's instructions on the label. Place a container with a capacity of approx. 2 litres underneath the hot water spout.
- Press the  button (**B7**); the descaling solution runs out of the hot water spout and starts to fill the container below. The message **DESCALING UNDERWAY...** is displayed.
- The descaling programme automatically follows a series of run-offs and pauses.
- After approximately 30 minutes, the display shows the message **RINSING. FILL TANK!**
- Empty the water tank, rinse it thoroughly to eliminate all traces of descaler and then fill it again with clean water.
- Fit the tank full of clean water back in the machine. The display shows the message **RINSING COMPLETE. PRESS** .
- Press  again (**B7**). Hot water runs out of the spout, filling the container, and the message **RINSING PLEASE WAIT...** is displayed.
- Wait for the message **RINSING COMPLETE. PRESS** .
- Press  (**B7**). The display shows the message **DESCALING COMPLETE**. The appliance goes off automatically.. Fill the tank again with clean water.
- The descaling programme is now complete and the machine is ready to prepare coffee again.

**N.B.:** if you interrupt the descaling cycle before it has been completed, you will have to start again from the beginning.







**N.B.: FAILURE TO DESCALE THE MACHINE REGULARLY WILL INVALIDATE THE MACHINE WARRANTY.**

## Resetting factory default values (reset)

To restore the machine's original default values (even after they have been changed), proceed as follows:









- Press the **MENU** button  (**B2**) to access the menu and then buttons   (**B5**) and (**B6**) until the display shows the message **DEFAULT VALUES**.
- Press  (**B7**), the display shows the message  **TO CONFIRM.**
- Press  (**B7**) to restore factory settings.

## Energy saving

- Press the icon  (B2) to enter the settings menu.
- Press the icons   (B5) and (B6) until **ENERGY SAVING** is displayed.
- Press the icon  (B7) **DISABLE?** is displayed (or **ENABLE?** if the function has already been disabled).
- Press the icon  (B7) to enable or disable the function or the icon  (B2) to exit the menu.

## Statistics







This function enables you to view the machine statistics. To view them, proceed as follows:

- Press the **MENU** button  (B2) to access the menu and then buttons   (B5) and (B6) until the machine shows the message **STATISTICS**.
- Press  (B7).
- Press buttons   (B5) and (B6) to verify:
  - how many coffees and cappuccinos have been made;
  - how many times the machine has been descaled;
  - the total number of litres of water run off.
- Press the **MENU** button  (B2) once to exit the function, or press **MENU** button  (B2) twice to exit the menu.

## Setting the tone

This function enables you to activate or deactivate an acoustic signal emitted by the machine each time a button is pressed and each time the accessories are inserted/removed.

**N.B.:** the machine is factory set with the acoustic signal activated.

- Press the **MENU** button  (B2) to access the menu and then buttons   (B5) and (B6) until the display shows the message **BEEP**.
- Press  (B7). The display shows the message **BEEP DISABLE?**
- Press  (B7) to deactivate the acoustic signal.
- Press the **MENU** button  (B2) to exit the menu.

## Programming coffee

For instructions on programming coffee, refer to chapter *CHANGING THE AMOUNT OF COFFEE IN THE CUP*.

## Programming cappuccino

For instructions on programming cappuccino, see chapter *CHANGING THE AMOUNT OF MILK AND COFFEE FOR CAPPUCCINO*.

## Cleaning and maintenance

### Cleaning the machine

Do not use solvents or abrasive detergents to clean the machine. A soft damp cloth will suffice. The following machine parts must be cleaned regularly:

- Coffee grounds container (A4).
- Drip tray (A14).
- Water tank (A12).
- Coffee spouts (A13).
- Feed funnel for adding pre-ground coffee (A21).
- The inside of the machine, accessed from the service door (A2).
- The brewing unit (A5).

### Cleaning the coffee grounds container

When the display shows the message **EMPTY GROUNDS CONTAINER!**, empty and clean the grounds container. To clean, proceed as follows:

- Open the service door on the front of the machine (Figure 16), next remove the drip tray (Figure 17), and clean it.
- Clean the coffee grounds container thoroughly.

**N.B.:** When removing the drip tray, the grounds container **MUST** be emptied.

## Cleaning the drip tray

### **⚠ WARNING:**

**If the drip tray is not emptied, the water can overflow. This can damage the machine.**

The drip tray has a water level indicator in the form of a red float (Figure 27). Empty and clean the drip tray before the red float protrudes from the cup tray.

To remove the drip tray:

1. Open the service door (Figure 16).
2. Remove the drip tray and the coffee grounds container (Figure 17).
3. Clean the drip tray and the grounds container (A4).
4. Fit the drip tray and the coffee grounds container back in place (A4).
5. Close the service door.

## Cleaning the water tank

1. Clean the water tank (A12) regularly (about once a month) with a damp cloth and a little mild detergent.
2. Take care to remove all traces of detergent.

## Cleaning the spouts

1. Clean the spouts regularly, using a sponge (Figure 28).
2. Check regularly that the holes in the coffee spout are not blocked. If necessary, remove coffee deposits with a toothpick (Figure 26).

## Cleaning the pre-ground coffee feed funnel

Check regularly (about once a month) that the feed funnel for pre-ground coffee is not blocked (Figure 20).

### **⚠ WARNING:**

**Before any cleaning operation, switch the machine off using the main switch (A23) and unplug it from the mains. Never immerse the coffee machine in water.**

## Cleaning the inside of the machine

1. Check regularly (about once a week) that the inside of the machine is not dirty. If necessary, remove coffee deposits with a sponge.
2. Remove any residues with a vacuum cleaner (Figure 29).

## Cleaning the brewing unit

The brewing unit must be cleaned at least once a month.

### **⚠ WARNING:**

**The brewing unit (A5) cannot be removed while the appliance is switched on. Do not attempt to use force to remove the brewing unit.**

1. Make sure that the machine is properly switched off (see SWITCHING OFF THE APPLIANCE).
2. Open the service door (Figure 16).
3. Remove the drip tray and the coffee grounds container (Figure 17).
4. Press the two red release buttons inwards and at the same time extract the brewing unit (Figure 30).

**N.B.:** Clean the brewing unit without any detergent since the inside of the piston is treated with lubricant which detergent would remove.

5. Soak the brewing unit in water for about 5 minutes, then rinse.
6. After cleaning, re-insert the brewing unit (A5) so that the support and the pin at the bottom are fully engaged; then push the PUSH symbol until it clicks into place.

- A. Support  
B. Pin

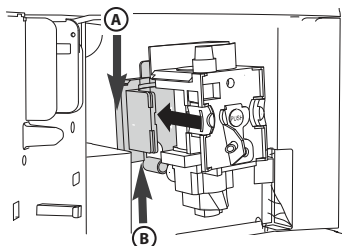

**N.B.:** If you encounter difficulty inserting the brewing unit, before inserting it adapt it to the right size by pressing it forcefully from both the bottom and top simultaneously as shown in the figure.

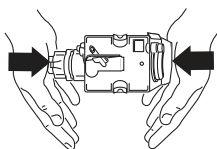

7. Once inserted, make sure the two red buttons have clicked out.

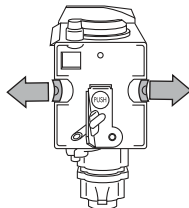

8. Replace the drip tray and coffee grounds container.

9. Close the service door.

### Cleaning the milk container



#### **WARNING:**

**Always clean the tubes inside the milk container (C) after preparing milk.**

If there is still milk in the container, do not leave it out of the refrigerator for longer than is strictly necessary.

Clean the container each time you prepare milk as described at point 3 in chapter *MAKING CAPPUCCINO*. All the components can be washed in the dishwasher, as long as they are placed in the top rack.

1. Turn the milk container lid clockwise and remove it.
2. Remove the milk spout and intake tube.

- A. Milk spout
- B. Intake tube
- C. Groove
- D. Pointer
- E. Hole

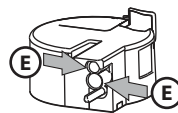
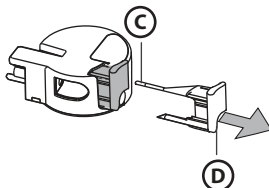
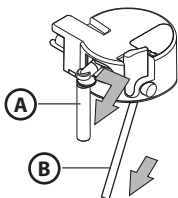

3. Remove the pointer by pulling it outwards.
4. Wash all the components thoroughly with hot water and mild detergent. Make sure there is no milk residue left inside the holes or the groove on the fine end of the pointer.
5. Check that the intake tube and spout are not clogged with milk residue.
6. Replace the pointer, milk spout and intake tube.
7. Replace the milk container lid.

### Switching off the appliance

Each time the appliance is switched off, it performs an automatic rinse which cannot be interrupted.



#### **WARNING:**

**During rinsing, some hot water is run off from the coffee spouts. Avoid contact with splashes of water. To switch the appliance off, press the on/stand-by button (A7). The appliance performs a rinse cycle and then switches off.**

**N.B.:** in the event of prolonged disuse, press the **ON/OFF** button (A23), on the side of the machine, in position **0**.

## Displayed messages

DISPLAYED MESSAGE	POSSIBLE CAUSE	REMEDY
<b>FILL TANK!</b>	- The water tank is empty or incorrectly positioned.	- Fill the tank with water and/or insert it correctly, pushing it as far as it will go.
<b>GROUND TOO FINE ADJUST MILL! INSERT WATER SPOUT AND PRESS <input checked="" type="checkbox"/> .</b>	- The ground is too fine so the coffee runs off too slowly.	- Turn the grinding adjustment knob one click towards number 7.
<b>GROUND TOO FINE ADJUST MILL!</b> <i>(alternating with)</i> <b>PRESS <input checked="" type="checkbox"/></b> <i>(and then)</i> <b>FILL TANK!</b>	- The tank was removed during run-off. - There is air in the hydraulic circuit.	- Replace the tank and press <input checked="" type="checkbox"/> (B7). The display shows <b>HOT WATER</b> . The machine runs off hot water and is then ready for use again.
<b>EMPTY GROUNDS CONTAINER!</b>	- The coffee grounds container (A4) is full or more than three days have passed since the last run-off (this operation ensures the machine remains hygienically clean).	- Empty and clean the grounds container, then replace it. <b>IMPORTANT:</b> when removing the drip tray, the grounds container <b>MUST</b> be emptied, even if it is not completely full. If this is not done, when you make the next coffees, the grounds container may fill up more than expected and clog the machine.
<b>INSERT GROUNDS CONTAINER!</b>	- After cleaning, the grounds container has not been replaced.	- Open the service door and insert the grounds container.
<b>ADD GROUND COFFEE!</b>	- The "pre-ground coffee" function has been selected without placing any pre-ground coffee in the funnel. - The funnel (A21) is blocked.	- Slide the machine out and, using the funnel, add pre-ground coffee. - Carefully use a knife to clear the funnel as described in paragraph <i>Cleaning the pre-ground coffee feed funnel</i> .
<b>DESCALE!</b> <i>(alternating with)</i> <b>MEDIUM CUP STANDARD TASTE</b>	- Indicates that descaling must be carried out.	- The descaling programme must be carried out as soon as possible, following instructions described in paragraph <i>DESCALING</i> .
<b>LESS COFFEE!</b>	- Too much coffee has been used.	- Select a milder taste or reduce the quantity of ground coffee, then run off the coffee again.
<b>FILL BEANS CONTAINER!</b>	- The coffee beans have run out.	- Fill the beans container.
<b>INSERT INFUSER ASSEMBLY!</b>	- The brewing unit has not been replaced after cleaning.	- Insert the brewing unit as described in paragraph <i>Cleaning the brewing unit</i> .
<b>CLOSE DOOR!</b>	- The service door is open.	- Close the service door.
<b>GENERAL ALARM!</b>	- The inside of the appliance is very dirty.	- Clean the inside of the appliance thoroughly, as described in chapter <i>CLEANING AND MAINTENANCE</i> . If the message is still displayed after cleaning, contact a service centre.



## Troubleshooting

Below is a list of some possible malfunctions.

If the problem cannot be resolved as described, contact After-sales Service.

PROBLEM	POSSIBLE CAUSE	REMEDY
The coffee is not hot.	<ul style="list-style-type: none"> <li>- The cups have not been pre-heated.</li> <li>- The brewing unit has cooled down because 2/3 minutes have elapsed since the last coffee was made.</li> <li>- The set temperature is not high enough.</li> </ul>	<ul style="list-style-type: none"> <li>- Heat the cups by rinsing them with hot water.</li> <li>- Before making coffee, heat the brewing unit by selecting the <b>RINSE</b> function from the menu.</li> <li>- Change the set temperature (see paragraph <i>Changing the coffee temperature</i>).</li> </ul>
The coffee is not creamy enough.	<ul style="list-style-type: none"> <li>- The coffee is ground too coarsely.</li> <li>- The blend of coffee is unsuitable.</li> </ul>	<ul style="list-style-type: none"> <li>- Turn the grinding adjustment knob one click anti-clockwise towards the number 1 while the coffee mill is in operation (Figure 14).</li> <li>- Use a blend of coffee specifically for espresso coffee machines.</li> </ul>
The coffee runs out too slowly or in drips.	<ul style="list-style-type: none"> <li>- The coffee is ground too finely.</li> </ul>	<ul style="list-style-type: none"> <li>- Turn the grinding adjustment knob one click clockwise towards the number 7 while the coffee mill is in operation (Figure 14). Continue one click at a time until coffee run-off is satisfactory. Results are only visible after running off 2 coffees.</li> </ul>
The coffee runs out too quickly.	<ul style="list-style-type: none"> <li>- The coffee is ground too coarsely.</li> </ul>	<ul style="list-style-type: none"> <li>- Turn the grinding adjustment knob one click anti-clockwise towards the number 1 while the coffee mill is in operation (Figure 14). Avoid turning the grinding coarseness regulator too far otherwise when you select 2 cups, the coffee may run out in drips. Results are only visible after running off 2 coffees.</li> </ul>
The coffee does not run out of one or either of the spouts.	<ul style="list-style-type: none"> <li>- The spouts are blocked.</li> </ul>	<ul style="list-style-type: none"> <li>- Clean the spouts with a toothpick (Figure 26).</li> </ul>
The coffee does not come out of the spouts, but around the service door (A2).	<ul style="list-style-type: none"> <li>- The holes in the spouts are clogged with dry coffee powder.</li> <li>- The coffee feed (A3) inside the service door is blocked.</li> </ul>	<ul style="list-style-type: none"> <li>- Clean the spouts with a toothpick, a sponge or a hard bristled kitchen brush (Figures 26-28).</li> <li>- Clean the coffee feed (A3) thoroughly, especially around the hinges.</li> </ul>
Water comes out of the spouts instead of coffee.	<ul style="list-style-type: none"> <li>- Ground coffee is blocking the funnel (A21)</li> </ul>	<ul style="list-style-type: none"> <li>- Clean the funnel (A21) with a wooden or plastic fork and clean the inside of the machine.</li> </ul>
The milk does not come out of the milk spout (C5).	<ul style="list-style-type: none"> <li>- The intake tube is not inserted or is inserted incorrectly.</li> </ul>	<ul style="list-style-type: none"> <li>- Insert the intake tube (C4) in the rubber washer in the milk container lid (Figure 23).</li> </ul>
The milk is not well frothed.	<ul style="list-style-type: none"> <li>- The milk container lid is dirty.</li> <li>- The milk pointer is incorrectly positioned.</li> </ul>	<ul style="list-style-type: none"> <li>- Clean the milk container lid as described in paragraph <i>Cleaning the milk container</i>.</li> <li>- Adjust the pointer as described in chapter <i>MAKING CAPPUCCINO</i>.</li> </ul>
The milk contains large bubbles or spurts out of the milk spout	<ul style="list-style-type: none"> <li>- The milk is not cold enough or is not semi-skimmed.</li> <li>- The milk frother pointer is incorrectly adjusted.</li> <li>- The milk container lid is dirty.</li> </ul>	<ul style="list-style-type: none"> <li>- Ideally, use skimmed milk at refrigerator temperature, or semi-skimmed milk at refrigerator temperature (about 5°C). If results are still not satisfactory, try changing brand of milk.</li> <li>- Move the pointer slightly towards the word <b>CAFFELATTE</b> (see chapter <i>MAKING CAPPUCCINO</i>).</li> <li>- Clean the milk container lid as described in paragraph <i>Cleaning the milk container</i>.</li> </ul>





Printed in Italy

10/2017

**400010867023A**

