

Instruction for use

KitchenAid

Installation	4
Product description	5
First time use	6
Advice and tips	8
Loading the racks	8
Selecting a cycle and options	10
Cycle table	11
Options and settings	12
Settings menu	13
Care and maintenance	14
Troubleshooting	15
After-sales service	17

Before using the appliance carefully read Health and Safety guide.

INSTALLATION

ATTENTION: If the appliance must be moved at any time, keep it in an upright position; if absolutely necessary, it may be tilted onto its back.

CONNECTING THE WATER SUPPLY

Adaptation of the water supply for installation should only be performed by a qualified technician.
The water inlet and outlet hoses may be positioned towards the right or the left in order to achieve the best possible installation.
Make sure the dishwasher does not bend or squash the hoses.

CONNECTING THE WATER INLET HOSE

- Run the water until it is perfectly clear.
 - Screw the inlet hose tightly into position and turn on the tap.
- If the inlet hose is not long enough, contact a specialist store or an authorised technician.

The water pressure must be within the values indicated in the Technical Data table - otherwise the dishwasher may not function properly. Make sure the hose is not bent or compressed.

SPECIFICATIONS FOR THE CONNECTION OF THE WATER SUPPLY HOSE:

WATER SUPPLY	cold or hot (max. 60°C)
WATER INTAKE	3/4"
POWER OF WATER PRESSURE	0,05 ÷ 1 MPa (0.5 ÷ 10 bar) 7,25 – 145 psi

CONNECTING THE WATER OUTLET HOSE

Connect the outlet hose to a drain duct with a minimum diameter of 2 cm **A**.

The outlet hose connection must be at a height ranging from 40 to 80 cm from the floor or surface where the dishwasher rests.

Before connecting the water outlet hose to the sink drain, remove the plastic plug **B**.

ANTI-FLOODING PROTECTION

Anti-flooding protection. To ensure floods do not occur, the dishwasher - is provided with a special system which blocks the water supply in the event of anomalies or leaks from inside the appliance.

Some models are also equipped with the supplementary safety device **New Aqua Stop**, which guarantees anti-flooding protection even in the event of a supply hose rupture.

Under no circumstances should the water inlet hose be cut as it contains live electrical parts.

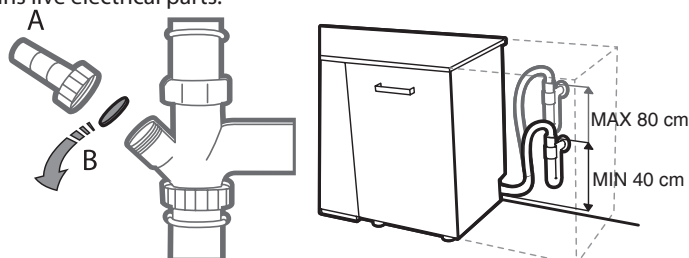

ELECTRICAL CONNECTION

⚡ WARNING: Under no circumstances should the water inlet hose be cut as it contains live electrical parts.

Before inserting the plug into the electrical socket, make sure that:

- The socket is **earth** and complies with current regulations;
- The socket can withstand the maximum load of the appliance as shown on the data plate located on the inside of the door (see *PRODUCT DESCRIPTION*).
- The power supply voltage falls within the values indicated on the data plate on the inside of the door.
- The socket is compatible with the plug of the appliance.

If this is not the case, ask an authorised technician to replace the plug (see *AFTER-SALES SERVICE*). Do not use extension cables or multiple sockets. Once the appliance has been installed, the power supply cable and the electrical socket should be easily accessible.

The cable should not be bent or compressed.

If the power supply cable is damaged, have it replaced by the manufacturer or its authorised Technical Assistance Service in order to prevent all potential hazards.

The Company shall not be held responsible for any incidents, if these regulations are not observed.

POSITIONING AND LEVELLING

1. Position the dishwasher on a level sturdy floor. If the floor is uneven, the front feet of the appliance may be adjusted until it reaches a horizontal position. If the appliance is levelled correctly, it will be more stable and much less likely to move or cause vibrations and noise while it is operating.
2. Before recessing the dishwasher, stick the adhesive transparent strip under the wooden shelf in order to protect it from any condensation which may form.
3. Place the dishwasher so that its sides or back panel are in contact with the adjacent cabinets or the wall. This appliance can also be recessed under a single worktop.
4. To adjust the height of the rear foot, turn the red hexagonal bushing on the lower central part at the front of the dishwasher using a hexagonal spanner with an opening of 8 mm. Turn the spanner in a clockwise direction to increase the height and in an anticlockwise direction to decrease it.

DIMENSIONS AND CAPACITY:

WIDTH	595 mm
HEIGHT	820 mm
DEPTH	555 mm
CAPACITY	14 standard place-settings

**The control panel of this dishwasher activates pushing by ON/OFF button.
For energy saving the control panel deactivates automatically after 10 minutes if no cycle has started.**

PRODUCT DESCRIPTION

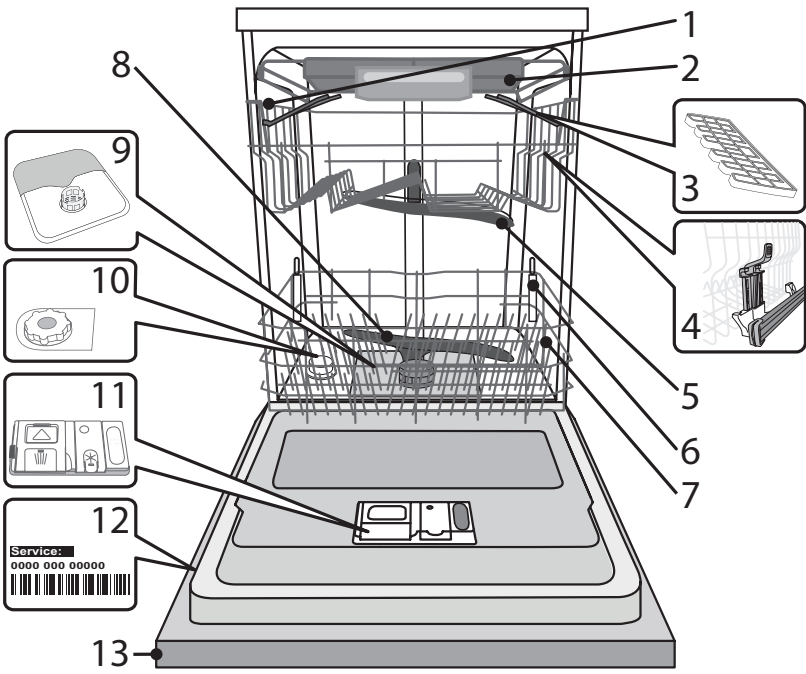

- 1. Upper rack
- 2. Cutlery rack
- 3. Foldable flaps
- 4. Upper rack height adjuster
- 5. Upper sprayer arm
- 6. Dynamic Clean support
- 7. Lower rack
- 8. Lower sprayer arm
- 9. Filter Assembly
- 10. Salt reservoir
- 11. Detergent and Rinse Aid dispensers
- 12. Rating plate
- 13. Control panel

CONTROL PANEL

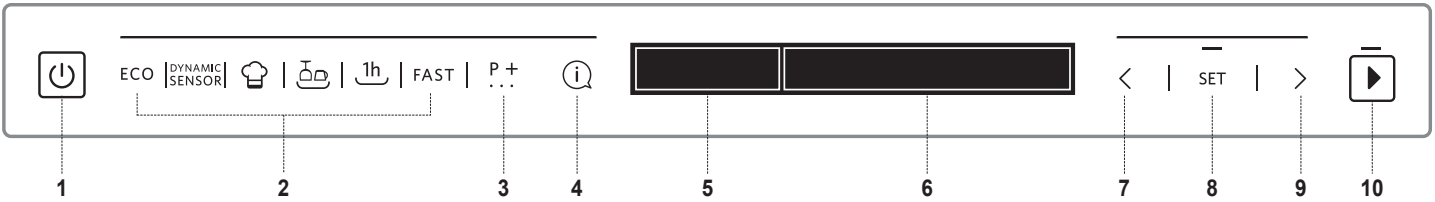

- 1. ON-OFF button
- 2. CYCLES 6 buttons for direct acces popular cycles
- 3. EXTRA CYCLES button. Access to other cycles
- 4. INFO button. Provide info for selected cycle
- 5. DISPLAY - Indicators area
- 6. DISPLAY - Information area
- 7. PREVIOUS button for options/settings
- 8. SET button. Select/change options and settings
- 9. NEXT button for options/settings
- 10. START button

DISPLAY - INDICATORS

A	B	C	
D	E		
I	H	G	F

- A. START DELAY
- B. ECO CYCLE
- C. MULTIZONE - Cutlery rack
- D. CLOSED WATER TAP
- E. ADD SALT
- F. MULTIZONE - Upper Rack
- G. MULTIZONE - Lower Rack
- H. ADD RINSE AID
- I. TABLET

FIRST TIME USE

After connecting the appliance to the power supply for the first time, the display will guide you to set up the appliance for first use.

1. The language selection

LANGUAGE: ENGLISH?
 <> = CHANGE OK = YES

ENGLISH
 SELECTED

To select preferred language please press button „<“ or „>“.

Confirm by pressing „SET“ button.

After language confirmation, the appliance will go through the first time use configuration menu.

2. Setting the water hardness

WATER HARDNESS
 (1=MIN, 5=MAX)

The water hardness is by default set to level 3. To change water hardness level press button „<“ or „>“ repeatedly.

WATER HARDNESS = 3
 <> = CHANGE OK = YES

To confirm your choice press „SET“ button. The level must be set according to the table below.

To allow the water softener to work in a perfect way, it is essential that the water hardness setting is based on the actual water hardness in your house. This information can be obtained from your local water supplier.

Water Hardness Table			
Level		German degrees °dH	French degrees °fH
1	Soft	0 - 6	0 - 10
2	Medium	7 - 11	11 - 20
3	Average	12 - 17	21 - 30
4	Hard	17 - 34	31 - 60
5	Very hard	35 - 50	61 - 90

3. Filling the water softener

POUR WATER OPERATION

When water hardness is set, it is required to fill water softener with water and special regeneration salt.

INSERT 1,5 LITER OF WATER IN THE RESERVOIR

Remove the lower rack and unscrew the reservoir cap (anticlockwise)

WATER IN THE RESERVOIR

As a first step it is needed to fill reservoir with water (~1.5 litres).

WATER SOFTENER OPERATION

Once done, proceed to the next step by pressing „SET“ button.

INSERT SALT OPERATION

ADD 1KG OF SALT IN THE SALT DISPENSER

OK = DONE

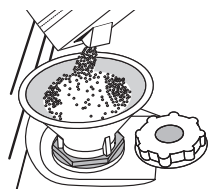

Position the funnel (see figure) and fill the salt reservoir right up to its edge (approximately 1 kg); it is not unusual for some water will spill out. Remove the funnel and wipe any salt residue away from the opening.

Make sure the cap is screwed on tightly, so that no detergent can get into the container during the wash program (this could damage the water softener beyond repair).

Once done, proceed to the next step by pressing „SET“ button.

Only use salt that has been specifically designed for dishwashers.

Whenever you need to add salt, we recommend carrying out the procedure just before the washing cycle is started.

Residual saline solution or grains of salt can lead to corrosion, irreparably damaging the stainless steel components.

The guarantee is not applicable if faults are caused by such circumstances.

If the salt container is not filled, the water softener and the heating element may be damaged as a result.

4. Setting the brightness level

ADJUST BRIGHTNESS
 (1=MIN, 5=MAX)

The brightness level is by default set to level 4. To change brightness level press button „<“ or „>“ repeatedly.

BRIGHTNESS = 5
 <> = CHANGE OK = YES

To confirm Your choice press „SET“ button.

5. Detergent type operation

DETERGENT TYPE OPERATION

DO YOU USE DOUBLE DETERGENT?

<> = NO OK = YES

“ALL IN ONE”

<> = NO OK = YES

DETERGENT?

<> = NO OK = YES

In this step it is very important to choose what type of detergent will be used (tablet/capsule or gel/powder).

If you prefer to use All-in-one detergent in tablet or capsule for washing - press „SET“, then go to step 7. **Open tap operation** on the next page.

The symbol  on display will be lit. If you prefer to use gel or powder detergent for washing, press „<“ or „>“, then go to step 6. **Rinse aid operation.**

6. Rinse aid operation*

*If All-in-one detergent was chosen in the previous step, this step will be skipped by the appliance.

RINSE AID OPERATION

INSERT RINSE AID IN THE DISPENSER

OK = DONE

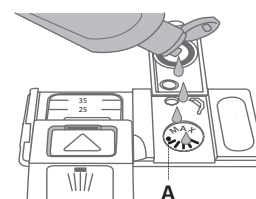
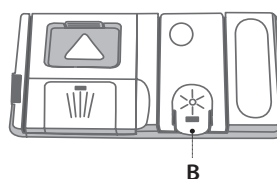

1. Open the dispenser **B** by pressing and pulling up the tab on the lid.
2. Carefully introduce the rinse aid as far as the maximum (110 ml) reference notch of the filling space **A** - avoid spilling it. If this happens, clean the spill immediately with a dry cloth.
3. Press the lid down until you hear a click to close it.
4. Confirm operation by pressing „SET“ button.

NEVER pour the rinse aid directly into the tub.

Setting rinse aid level

(not necessary when using tablets/capsules)

The rinse aid dosage can be adjusted to the detergent used. The lower the setting, the less rinse aid is dispensed. The factory setting is for (4) level.

To change, follow instructions in section “SETTINGS / MENU”.

7. Open tap operation

OPEN TAP OPERATION
OPEN THE OK = DONE
WATER TAP OK = DONE



Check water tap is open. If closed, open it then confirm by pressing „SET“ button.

8. First cycle operation

FIRST CYCLE OPERATION
REMEMBER TO RUN THE OK = DONE
INTENSIVE CYCLE OK = DONE
WITH EMPTY BASKETS OK = DONE
TO COMPLETE OK = DONE
THE FIRST SET UP OK = EXIT

Before normal use of appliance it is recommended to run Intensive cycle first, to calibrate the appliance.

Insert a detergent into dispenser chamber **B** (see below), then press „SET“ button.

Intensive cycle will be selected automatically. Press „START“  button and close the appliance door.

This first cycle can be up to 20 minutes longer as a result of the automatic calibration process.

After this process the appliance is ready for normal use.

ADDING A DETERGENT

Only use detergent which has been specifically designed for dishwashers.

To achieve the best washing and drying results, the combined use of detergent, rinse aid liquid and refined salt is required.

We recommend using detergents that do not contain phosphates or chlorine, as these products are harmful to the environment.

Good washing results also depend on the correct amount of detergent being used.

Exceeding the stated amount does not result in a more effective wash and increases environmental pollution.

The amount can be adjusted to the soil level. In the case of normally soiled items, use approximately either 35g (powder detergent) or 35ml (liquid detergent) and additional tea spoon of detergent directly inside the tub. If tablets are used, one tablet will be enough.

If the crockery is only lightly soiled or if it has been rinsed with water before being placed in the dishwasher, reduce the amount of detergent used accordingly (minimum 25 g/ml) e.g. skip the powder/gel putted inside the tub.

To open the detergent dispenser, press button **A**. Introduce the detergent into the dry dispenser **B** only. Place the amount of detergent for pre-washing directly inside the tub.

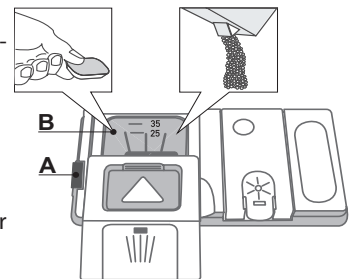

1. When measuring out the detergent refer to the mentioned earlier information to add the proper quantity. Inside the dispenser **B** there are indications to help the detergent dosing.

2. Remove detergent residues from the edges of the dispenser and close the cover until it clicks.

3. Close the lid of the detergent dispenser by pulling it up until the closing device is secured in place.

The detergent dispenser automatically opens up at the right time according to the program.

If you are using a All-in-one detergents, we recommend that you add salt in any case, especially if the water is hard or very hard (follow the instructions given on the packaging).

ADVICE AND TIPS

TIPS

Before loading the baskets, remove all food residues from the crockery and empty the glasses. You do not need to rinse beforehand under running water.

Arrange the crockery so that it is held in place firmly and does not tip over; and arrange the containers with the openings facing downwards and the concave/convex parts placed obliquely, thus allowing the water to reach every surface and flow freely.

Warning: lids, handles, trays and frying pans do not prevent the sprayer arms from rotating.

Place any small items in the cutlery basket.

Very soiled dishes and pans should be placed in the lower basket because in this sector the water sprays are stronger and allow a higher washing performance.

After loading the appliance, make sure that the sprayer arms can rotate freely.

HYGIENE

To avoid odour and sediment which can be accumulated in the dishwasher please run a high temperature program at least once a month. Use a tea spoon of detergent and run it without the loading to clean your appliance.

UNSUITABLE CROCKERY

- Wooden crockery and cutlery.
- Delicate decorated glasses, artistic handicraft and antique crockery. Their decorations are not resistant.
- Parts in synthetic material which do not withstand high temperatures.
- Copper and tin crockery.
- Crockery soiled with ash, wax, lubricating grease or ink.

The colours of glass decorations and aluminium/silver pieces can change and fade during the washing process. Some types of glass (e.g. crystal objects) can become opaque after a number of wash cycles too.

DAMAGE TO GLASS AND CROCKERY

- Only use glasses and porcelain guaranteed by the manufacturer as dishwasher safe.
- Use a delicate detergent suitable for crockery
- Collect glasses and cutlery from the dishwasher as soon as the wash cycle is over.

LOADING THE RACKS

CUTLERY RACK

The third rack was designed to house the cutlery.

Arrange the cutlery as shown in the figure.

A separate arrangement of the cutlery makes collection easier after washing and improves washing and drying performance.

Knives and other utensils with sharp edges must be positioned with the blades facing downwards.

The geometry of the rack makes it possible to place such small items as coffee cups in the area in the middle.

The cutlery basket is equipped with two sliding side trays to make the most of the height of the space below and enable the loading of high items into upper rack.

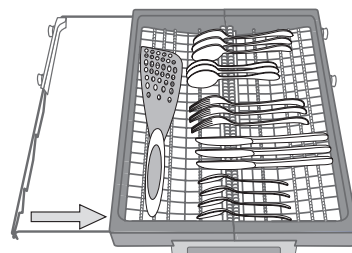
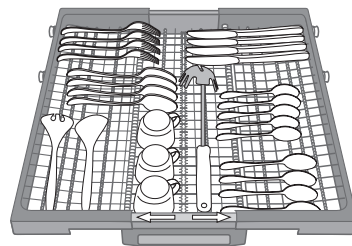
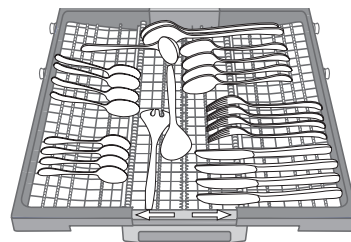

UPPER RACK

Load delicate and light dishes:- glasses, cups, saucers, low salad bowls.

The upper rack has tip-up supports which can be used in a vertical position when arranging tea/ dessert saucers or in a lower position to load bowls and food containers.

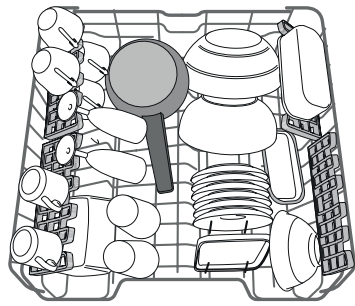

(loading example for the upper rack)

FOLDABLE FLAPS WITH ADJUSTABLE POSITION

The side foldable flaps can be positioned at three different heights to optimize the arrangement of crockery inside the rack.

Wine glasses can be placed safely in the foldable flaps by inserting the stem of each glass into the corresponding slots.

For optimum drying results incline the foldable flaps more. To change the inclination, pull up the foldable flap, slide it slightly and position it as you wish.

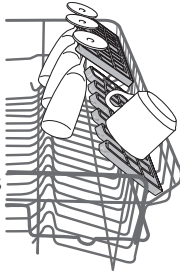

ADJUSTING THE HEIGHT OF THE UPPER RACK

The height of the upper rack can be adjusted: high position to place bulky crockery in the lower basket and low position to make the most of the tip-up supports by creating more space upwards and avoid collision with the items loaded into lower rack.

The upper rack is equipped with a **Upper Rack height adjuster** (see figure), without pressing the levers, lift it up by simply holding the rack sides, as soon as the rack is stable in its upper position.

To restore to the lower position, press the levers **A** at the sides of the rack and move the basket downwards.

We strongly recommend that you do not adjust the height of the rack when it is loaded.

NEVER raise or lower the basket on one side only.

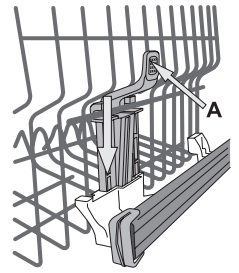

LOWER RACK

For pots, lids, plates, salad bowls, cutlery etc. Large plates and lids should ideally be placed at the sides to avoid interferences with the spray arm.

The lower rack has tip-up supports which can be used in a vertical position when arranging plates or in a horizontal position (lower) to load pans and salad bowls easily.

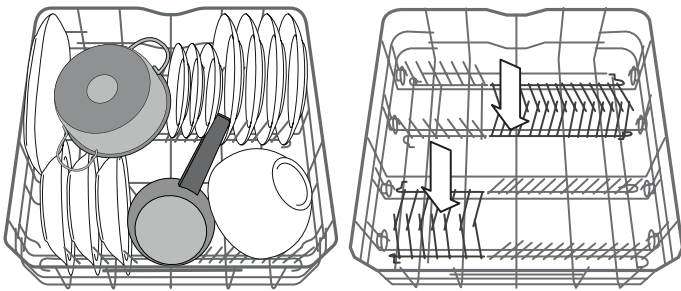

(loading example for the lower rack)

GLASS CARE

Dedicated accessory that allows you to safely store different types of stem glasses in the lower rack. It enables cleaning & drying results by allowing an optimised and stable positioning of the glasses.

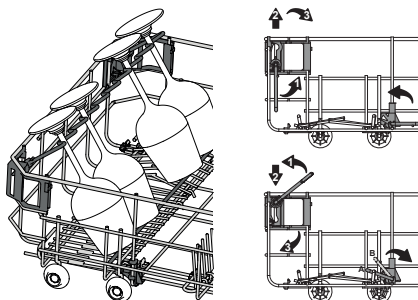

DYNAMIC CLEAN IN LOWER RACK

Dynamic Clean uses the special water jets in the rear of cavity to wash more intensively the high dirty items.

Placing the pots/casseroles faced to the Dynamic Clean® component please activate the **DYNAMIC CLEAN** on the panel.

The lower rack has a Dynamic Clean, a special pull-out support in the rear of the rack that can be used to support frying pans or baking pans in upright position, thus taking up less space.

How to use Dynamic Clean:

1. Adjust the Dynamic Clean area (G) folding down the rear plate holders to load pots.
2. Load pots and casseroles inclined vertically in Dynamic Clean area. Pots have to be inclined towards the power water jets.

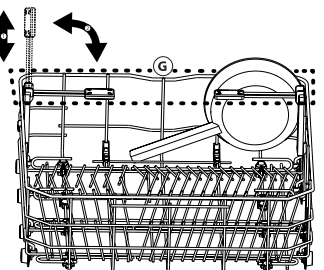
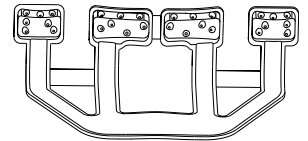

SELECTING A CYCLE AND OPTIONS

The list of available cycles and options can be found in **Cycle Table** on next page. Eco cycle is selected by default. If you want to have Last Used cycle selected by default, you can change it in „Settings Menu“.

It is possible to select a cycle by pressing 1 of 6 cycles direct access buttons or by pressing „Extra Cycles“  button repeatedly. When the last one is reached a further press goes back to the first.

Press cycle button to choose cycle in accordance with the level of soiling of the dishes and with Cycle Table. Information will be shown on the display:

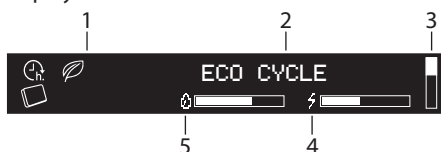

1. Indicators
2. Name of the selected cycle
3. Vertical bar showing the position of the extra cycle list only
4. Energy consumption of the selected cycle
5. Water consumption of the selected cycle

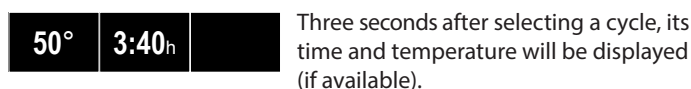



Press „INFO“  button to display a brief description of the cycle and its water / energy consumption.



During the selection phase the „START“  LED blinks.

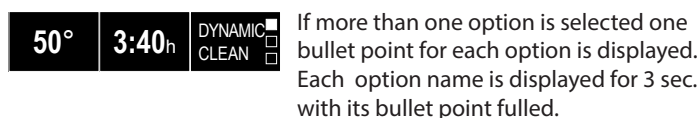

Additional options are available for most cycles (see „Options and Settings“ section). When any option is selected, its name is shown on the display on the right.



When the cycle and option selection is complete, press „START“  button and close the door within 4 seconds to start chosen cycle.

MODIFYING A RUNNING PROGRAM

If a wrong program was selected, it is possible to change it, provided that it has only just begun: open the door, press and hold the „ON/OFF“  button, the machine will switch off.

Switch the machine back on using the „ON/OFF“  button and select the new wash cycle and any desired options; start the cycle by pressing the „START“  button and closing the door.

TO PAUSE THE CYCLE (ADDING EXTRA ITEMS)

Open the door and place the crockery inside the dishwasher, (beware of HOT steam!). Press „START“  button and close the door within 4 sec. to resume the cycle from the point at which it was interrupted.

ACCIDENTAL INTERRUPTIONS

If the door is opened during the wash cycle, or if there is a power cut, the cycle stops. To resume the cycle from where it was interrupted, press the „START“  button and close the door within 4 sec.

After the cycle finishes, there is an acoustic signal and the display shows:



On the display additional information can be shown:



- ADD SALT - refill salt reservoir.
- ADD RINSE AID - refill rinse aid.
- WPRO - every 50 cycle, will be recommended to use the WPRO cleaner (according to instruction on the consumable).

Open appliance door (beware of hot steam!) and unload the racks, starting from the lower rack first.

If it is needed to refill salt reservoir or rinse aid dispenser, it is recommended to do this operations right before start of the next cycle.

After 10 minutes the appliance switches off.

CYCLES TABLE

CYCLE	Available options *	Detergent dispenser		Duration of wash cycle (h:min)*	Water consumption (l/cycle)	Energy consumption (kWh/cycle)	Drying phase
		B	TUB				
ECO 50°	TABLET, START DELAY, DYNAMIC CLEAN, BOOST	✓	✓	3:40	9.5	0.83	✓
DYNAMIC SENSOR DYNAMIC SENSOR 50-60°	TABLET, START DELAY, MULTIZONE, DYNAMIC CLEAN, BOOST	✓	✓	1:25 - 3:00	7.0 - 14.0	0.90 - 1.40	✓
 PROFESSIONAL 65°	TABLET, START DELAY, MULTIZONE, DYNAMIC CLEAN	✓	-	2:27	16.5	1.70	✓
 DAILY 50°	TABLET, START DELAY, MULTIZONE	✓	-	1:30	13.0	1.15	✓
 1H WASH & DRY 55°	TABLET, START DELAY, MULTIZONE	✓	-	1:00	10.5	1.20	✓
FAST 30' FAST 50°	TABLET, START DELAY	✓	-	0:30	9.0	0.55	-
EXTRA CYCLES - available by pressing P.† button							
GLASS 45°	TABLET, START DELAY, MULTIZONE, BOOST	✓	-	2:05	11.5	1.20	✓
PRE-WASH cold	START DELAY, MULTIZONE	-	-	0:12	4.5	0.01	-
SELF CLEAN 65°	START DELAY	✓	-	0:50	8.0	0.85	✓

- ECO** - Normally soiled crockery. standard program, the most efficient in terms of its combined energy and water consumption.
- DYNAMIC SENSOR** - For normally soiled dishes with dried food residues. Senses the level of soiling on the dishes and adjusts the program accordingly.
- PROFESSIONAL** - Program recommended for heavily soiled crockery, especially suitable for pans and saucepans (not to be used for delicate items).
- DAILY** - Normally soiled crockery. everyday cycle, that ensures optimal cleaning performance in shorter time.
- 1H WASH & DRY** - Light to normally soiled crockery. Everyday program suitable for non-dried and fresh soiling, assuring clean and dried dishes in just 60 min of time.
- FAST 30'** - Program to be used for lightly-soiled dishes with no dried food residues.

P.† **EXTRA CYCLES**

- GLASS** - Program for delicate items, which are more sensitive to high temperatures, for example glasses and cups.
- PRE-WASH** - Crockery to be washed later. No detergent to be used with this program.
- SELF CLEAN** - Program to be used to perform maintenance of the dishwasher. It cleans the interior of the appliance using hot water.

Notes:

To reduce consumption even further, only run the dishwasher when it is full.
Please note that cycles like Rapid or Fast are most effective for lightly soiled dishes.

ECO program data is measured under laboratory conditions according to European Standard EN 50242.

* Not all options can be used simultaneously.

** The duration of the program shown on the display or in the booklet is an estimate calculated on standard conditions. The actual time may vary depending on many factors such as temperature and pressure of the incoming water, room temperature, amount of detergent, quantity and type of load, load balancing, additional selected options and sensor calibration. The sensor calibration can increase program duration up to 20 min.

Standby consumption: Left-on mode consumption: 5 W - Off mode consumption: 0.5 W

OPTIONS AND SETTINGS

With each cycle additional options can be used. A full list of available options working with specific cycles can be found in the **Cycle Table** on the previous page. All active options are shown on the display.

To set an option press „SET” button. SET OPTIONS message is shown for a few seconds. Then use „<” or „>” button to navigate through the option list. Press „SET” to select the option, in the setting menu the LED above „SET” button is lit.

If the option is not available, it will be still visible in its position but with „”

TABLET (All-in-one)

This setting allows you to optimise the performance of the cycle according to the type of detergent used. Enable it if you use combined detergents in tablet form (rinse aid, salt and detergent in 1 dose).

TABLET	OFF
TABLET	ON
TABLET	ON

To set the Tablet, enter in the setting menu by pressing „SET” button and navigate with „< , >” until „TABLET” is shown, then press „SET” button.

START DELAY

The start of the cycle may be delayed for a selected period of time.

To set a delay, enter in the setting menu by pressing „SET” button and navigate with „< , >” until „START DELAY” is shown, then press „SET” button.

With each press of the button „>” or „<”, the delay start increases by:

- every 0:30 if selection below 4 hours,
- every 1:00 if selection is below 12 hours,
- every 2 hours if selection is above 12 hours.

START DELAY	OFF
<STARTS IN h>	OFF
<STARTS IN h>	4:00
<STARTS IN h>	4:00

Default value is OFF.

If delay is selected, the is lit .

Once „SET” button is pressed the delay is confirmed and the machine comes back to the cycle selection screen with delay value visible.

Press „START” and close the door within 4 sec. to start the delay

To remove the delay has to scroll until „OFF” is displayed (after 24:00 by pressing „>” button has to show „OFF”).

MULTIZONE

If there are not many dishes to be washed it can be loaded in one rack only. Using this option you can select which rack you want to wash.

To set the Multizone, enter in the setting menu by pressing „SET” button and navigate with „< , >” until „MULTIZONE” is shown, then press „SET” button.

MULTIZONE	OK
<ALL RACKS>	< >
<LOW ONLY>	< >
<HIGH ONLY>	< >
<CUTLERY ONLY>	< >
<CUTLERY ONLY>	

By default the MULTIZONE is not active and all racks icons are lit.  

The multizone icon becomes lit.  

The multizone icon becomes lit.  

The multizone icon becomes lit.  

DYNAMIC CLEAN

Thanks to additional water jets this option provides a more intensive and powerful wash in the specific area of lower rack.

DYNAMIC CLEAN	OFF
DYNAMIC CLEAN	ON
DYNAMIC CLEAN	ON

Default value is OFF.

To set the Dynamic Clean, enter in the setting menu by pressing „SET” button and navigate with „< , >” until „DYNAMIC CLEAN” is shown, then press „SET” button.

BOOST

The boost option delivers a cut 25%-67% of the duration for main cycles, while ensuring an optimal level of washing and drying. In order to do that it will require water and energy consumption compared to the regular full-length cycle. The option can be selected on programs: Eco 50°, Dynamic Sensor 50-60°, Glass 45°.

BOOST	OFF
BOOST	ON
BOOST	ON

To set the Boost, enter in the setting menu by pressing „SET” button and navigate with „< , >” until „BOOST” is shown, then press „SET” button.

With each press of the button „>” or „<” option will be ON or OFF. Confirm by pressing „SET” button.

FLOOR LIGHT

A LED light projected on the floor indicates that the dishwasher is working. The light stays on during the cycle and switches off at the end of the cycle.

This feature is active by default, but it is possible to deactivate it in the “SETTINGS MENU”.

TUB LIGHT

When the feature is active the LEDs in the tub are automatically switched on/off as soon as the user open/close the door respectively.

If the door remains opened for more than 10 min, the LEDs in the tub switch off (to turn them on again, the door has to be closed and opened again). This feature is active by default, but it is possible to deactivate it in the “SETTINGS MENU”.

SETTINGS MENU

To change machine settings you need to enter into the Settings Menu.

Press „SET“ button and navigate with „< , >“ until **SETTINGS** is shown, then press „SET“ button.

To exit the setting menu, press any cycle button or press „< , >“ button until **EXIT** is shown, then press „SET“ button.

Language

1. LANGUAGE	OK	To change language, enter in the setting menu by pressing „SET“ button and navigate with „< , >“ until „LANGUAGE“ is shown, then press „SET“ button.
1. ITALIAN	< >	
1. ENGLISH		

First cycle

2. FIRST CYCLE	OK	You can choose which cycle is selected by default when switching on the appliance: ECO or the LAST USED one. To change first cycle, enter in the setting menu by pressing „SET“ button and navigate with „< , >“ until „FIRST CYCLE“ is shown, then press „SET“ button.
2. <ECO>	< >	
2. <LAST USED>		

Sounds

3. SOUNDS	OK	To change sounds, enter in the setting menu by pressing „SET“ button and navigate with „< , >“ until „SOUNDS“ is shown, then press „SET“ button. Choose between 2 levels: <i>High</i> ; <i>Low</i> . Can be also <i>OFF</i> .
3. <HIGH>	< >	
3. <OFF>		

Water Hardness

4. WATER HARDNESS	3	To change water hardness level, enter in the setting menu by pressing „SET“ button and navigate with „< , >“ until „WATER HARDNESS“ is shown, then press „SET“ button.
4. WATER HARDNESS	4	

To setup correct level according to water hardness, see table on page 6.

Screen Brightness

5. SCREEN BRIGHT.	5	To change screen brightness level, enter in the setting menu by pressing „SET“ button and navigate with „< , >“ until „SCREEN BRIGHT.“ is shown, then press „SET“ button.
5. SCREEN BRIGHT.	3	

Choose between five levels: 1, 2, 3, 4 and 5.

Floor Light

6. FLOOR LIGHT	ON	To change floor light, enter in the setting menu by pressing „SET“ button and navigate with „< , >“ until „FLOOR LIGHT“ is shown, then press „SET“ button.
6. FLOOR LIGHT	OFF	

Tub Light

7. TUB LIGHT	ON	To change tub light, enter in the setting menu by pressing „SET“ button and navigate with „< , >“ until „TUB LIGHT“ is shown, then press „SET“ button.
7. TUB LIGHT	OFF	

Rinse Aid level

8. RINSE AID LEV.	4	To change rinse aid level, enter in the setting menu by pressing „SET“ button and navigate with „< , >“ until „RINSE AID LEV.“ is shown, then press „SET“ button.
8. RINSE AID LEV.	5	

Choose between five levels: 1, 2, 3, 4 and 5.

If the rinse aid level is set to 1, no rinse aid will be supplied. The LOW RINSE AID indicator light will not be lit if you run out of rinse aid.

The factory setting is for (4)level .

- If you see bluish streaks on the dishes, set a low number (2-3).
- If there are drops of water or limescale marks on the dishes, set a high number (4-5).

Demo mode

9. DEMO MODE	ON	To see to demo mode, enter in the setting menu by pressing „SET“ button and navigate with „< , >“ until „DEMO MODE“ is shown, then press „SET“ button.
9. DEMO MODE	OFF	

Reset to factory default

10. RESET TO DEF.	ON	To reset to factory default, enter in the setting menu by pressing „SET“ button and navigate with „< , >“ until „RESET TO DEF.“ is shown, then press „SET“ button.
10. RESET TO DEF.	OFF	

Exit

11. EXIT	< >	To exit the setting menu, press any cycle button or press „< , >“ button until EXIT is shown, then press „SET“ button.
----------	-----	---

CARE AND MAINTENANCE

ATTENTION: Always unplug the appliance when cleaning it and when performing maintenance work. Do not use flammable liquids to clean the machine.

CLEANING THE DISHWASHER

Any marks on the inside of the appliance may be removed using a cloth dampened with water and a little vinegar.

The external surfaces of the machine and the control panel can be cleaned using a non-abrasive cloth which has been dampened with water. Do not use solvents or abrasive products.



PREVENTING UNPLEASANT ODOURS

Always keep the door of the appliance ajar in order to avoid moisture from forming and being trapped inside the machine. Clean the seals around the door and detergent dispensers regularly using a damp sponge. This will avoid food becoming trapped in the seals, which is the main cause behind the formation of unpleasant odours.

CHEKING THE WATER SUPPLY HOSE

Check the inlet hose regularly for brittleness and cracks. If damaged, replace it by a new hose available through our After-Sales Service or your specialist dealer. Depending on the hose type:

If the inlet hose has a transparent coating, periodically check if the colour intensifies locally. If yes, the hose may have a leak and should be replaced.

For water stop hoses: check the small safety valve inspection window

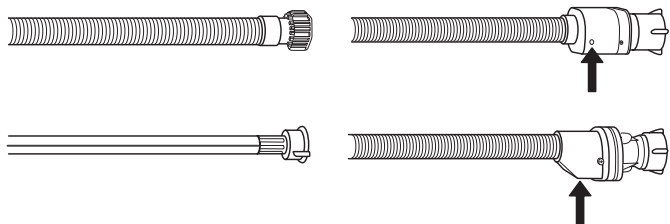

(see arrow). If it is red, the water stop function was triggered, and the hose must be replaced by a new one.

For unscrewing this hose, press the release button while unscrewing the hose.

CLEANING THE WATER INLET HOSE

If the water hoses are new or have not been used for an extended period of time, let the water run to make sure it is clear and free of impurities before performing the necessary connections. If this precaution is not taken, the water inlet could become blocked and damage the dishwasher.

CLEANING THE FILTER ASSEMBLY

Regularly clean the filter assembly so that the filters do not clog and that the waste water flows away correctly.

The filter assembly consists of three filters which remove food residues from the washing water and then recirculate the water: to obtain the best washing results, you need to keep them clean.

The dishwasher must not be used without filters or if the filter is loose.

After several washes, check the filter assembly and if necessary clean it thoroughly under running water, using a non-metallic brush and following the instructions below:

1. Turn the cylindrical filter **A** in an anti-clockwise direction and pull it out (Fig 1).
2. Remove the cup filter **B** by exerting a slight pressure on the side flaps (Fig 2).

3. Slide out the stainless-steel plate filter **C** (Fig 3).

4. Inspect the trap and remove any food residues. **NEVER REMOVE** the wash-cycle pump protection (black detail) (Fig 4).

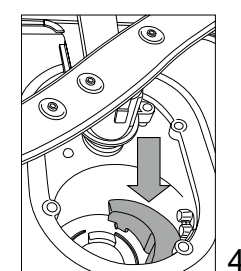
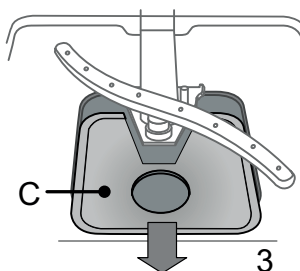
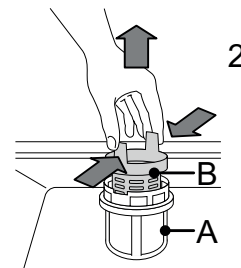
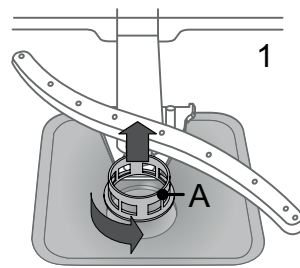

After cleaning the filters, re-place the filter assembly and fix it in position correctly; this is essential for maintaining the efficient operation of the dishwasher.

CLEANING THE SPRAY ARMS

On occasions, food residue may become encrusted onto the spray arms and block the holes used to spray the water. It is therefore recommended that you check the arms from time to time and clean them with a small non-metallic brush.

To remove the upper spray arm, turn the plastic locking ring in an anti-clockwise direction. The upper spray arm should be replaced so that the side with the greater number of holes is facing upwards.

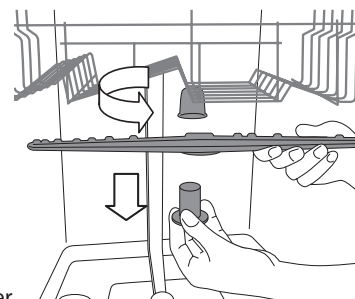

The lower spray arm may be removed by pulling it upwards.

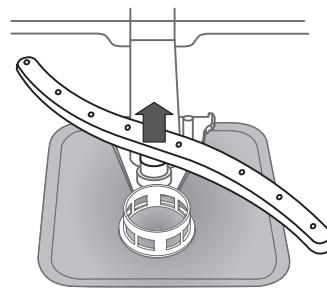

TROUBLESHOOTING

**Your dishwasher may not work properly.
Before contacting the After-sales Service, check if the problem can be solved by going through the following list.**

PROBLEMS	POSSIBLE CAUSES	SOLUTIONS
Display shows: CHECK SALT or ADD SALT	Salt reservoir is empty.	Refill reservoir with salt (see page 6). Adjust water hardness (see page 6).
Display shows: CHECK RINSE AID or ADD RINSE AID	Rinse aid dispenser is empty.	Refill dispenser with rinse aid (see page 6).
... is not working / will not start.	The appliance must be switched on.	Check the household circuit fuse if there is no power supply.
	The appliance door doesn't close.	Check if the appliance door is closed.
	"Start Delay" option is ON.	Check whether the „Start Delay“ option has been selected. If it has, the appliance will start once the set time has elapsed. If necessary, Reset the current cycle by switching OFF the dishwasher, then switch it on again, select a new cycle, press START and close the door.
Display shows: F6  symbol on the display indicators	Water pressure is too low.	The water tap must be fully open during water inlet (minimum capacity: 0.5 litres per minute).
	Kinked water inlet hose or clogged inlet filters.	The water inlet hose must not be kinked and the inlet filter in the water tap connector must not be dirty or clogged.
Display shows: F3	Dirty filters.	Clean the filters.
	Kinked drain hose.	The drain hose must not be kinked.
	Syphon hose connection closed.	The closure disk of the syphon hose connection must be removed.
Display shows: F2	Dirty filters or spray arms.	Clean filters and spray arms.
	Too little water in the appliance system.	Concave items (e.g. bowls, cups) must be arranged facing downwards in the rack.
	Drain hose incorrectly fitted.	The drain hose must be fitted correctly (for high mounted appliances, leave min. 200 - 400mm from the lower edge of the appliance) - see Installation.
	High level of foam inside.	Repeat without detergent or wait until foam disappears..
	Water pressure is too low.	The water tap must be fully open during water inlet (minimum capacity: 0.5 litres per minute).
	Kinked water inlet hose or clogged inlet filters.	The water inlet hose must not be kinked and the inlet filter in the water tap connector must not be dirty or clogged.
Display shows: PRESS START AND CLOSE THE DOOR	Door is not closed within 4 seconds of button press.	Press again and close the appliance door within 4 seconds.
Display shows: OPEN AND CLOSE THE DOOR	The door was not open between cycles.	Unload appliance (if not unloaded before), open and close the door.
Display shows: Fx	Appliance has technical defect.	Call customer service (state fault displayed). Close the water tap.

PROBLEMS	POSSIBLE CAUSES	SOLUTIONS
The door doesn't lock.	Racks are not fit to the end.	Verify that racks are fit to the end.
	The door is not lock.	Vigorously push the door until you hear the "clack" sound.
The dishwasher makes excessive noise.	The dishes are rattling against each.	Arrange the crockery correctly (see <i>Loading the Racks</i>).
	An excessive amount of foam has been produced.	The detergent has not been measured out correctly or it is not suitable for use in dishwashers (see <i>Filling the Detergent Dispenser</i>). Reset the current cycle by switching OFF the dishwasher, then switch it on again, select a new program, press START and close the door. Please do not add any detergent.
The dishes have not been dried.	The selected program hasn't any drying phase.	Verify on the programs table if the selected program has the drying phase.
	The rinse aid has run out or the resolution is not adequate.	Add the rinse aid or adjust the dosage levels higher (see <i>Filling the Rinse Aid Dispenser</i>).
	The dishes are made of non-stick or plastic.	It is normal the presence of drops of water (see <i>Tips</i>).
The dishes are not clean.	The crockery has not been arranged properly.	Arrange the crockery correctly (see <i>Loading the Racks</i>).
	The spray arms cannot rotate freely, being hindered by the dishes.	Arrange the crockery correctly (see <i>Loading the Racks</i>).
	The wash cycle is too gentle and/or detergent efficiency is low.	Select an appropriate wash cycle (see <i>Programs Table</i>).
	An excessive amount of foam has been produced (see <i>AFTER-SALES SERVICE</i>).	The detergent has not been measured out correctly or it is not suitable for use in dishwashers (see <i>Filling the Detergent Dispenser</i>). Reset the current cycle by switching OFF the dishwasher, then switch it on again, select a new program, press START and close the door. Please do not add any detergent.
	The cap on the rinse aid compartment has not been shut correctly.	Make sure the cap of the rinse aid dispenser is closed.
	The filter is soiled or clogged.	Clean the filter assembly (see <i>Care and Maintenance</i>).
	There is no salt.	Fill the salt reservoir (see <i>Filling the Salt Reservoir</i>).
The dishes and glasses show calcination or a whitish film.	The salt level is too low.	Fill the salt reservoir (see <i>Filling the Salt Reservoir</i>).
	The adjustment of the water hardness is not adequate.	Increase the values (see <i>Water Hardness Table</i>).
	The cap of the salt reservoir is not properly closed.	Check to have properly closed the salt reservoir cap.
	The rinse aid is used up or the dosage is insufficient.	Add the rinse aid or adjust the dosage levels higher.
The dishes and glasses are blue streaked or have a bluish tinge.	The rinse aid dosage is excessive.	Adjust the dosage rates below.

AFTER-SALES SERVICE

PRODUCT FISCHE

The technical data containing the energy consumption data can be downloaded from the website: <http://docs.kitchenaid.eu>

CONTACTING AFTER-SALES SERVICE

You can find our contact details in the warranty manual. When contacting our Client After-sales Service, please state the codes provided on your product's rating plate.

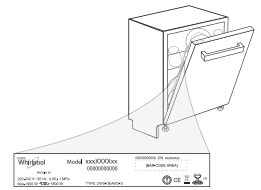



FOR THE WAY IT'S MADE.

Printed in Italy
09/17

400011168109

EN