

# DSIE 2B10

12NC: F155796

GTIN (EAN) code: 8050147557969

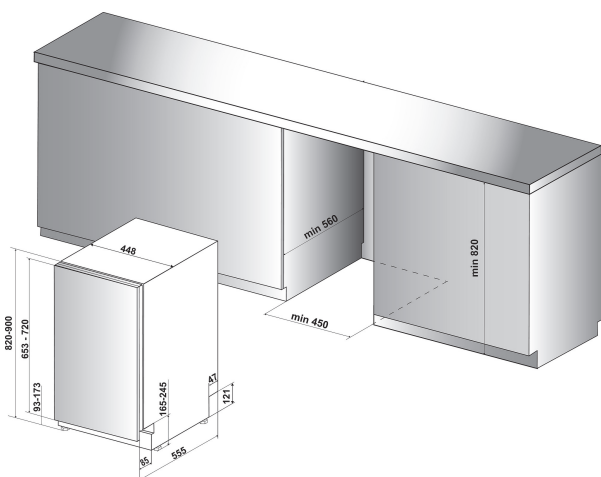

## MAIN FEATURES

Construction type	Ugradbeni
Installation type	Potpuno integrirana
Type of control	Electronic
Type of control settings	-
Removable work top	-
Door decor panel	-
Main colour of product	White
Electrical connection rating (W)	1900
Current (A)	10
Voltage (V)	220-240
Frequency (Hz)	50
Length of Electrical Supply Cord (cm)	130
Plug type	Schuko
Length inlet hose (cm)	155
Length outlet hose (cm)	150
Adjustable plinth	Ne
Height of removable worktop (mm)	0
Adjustable feet	Yes - all from front
Height of the product	820
Width of the product	448
Depth of the product	555
Depth with open door 90 degree (mm)	-
Minimum niche height	820
Maximum niche height	900
Minimum niche width	450
Maximum niche width	600
Niche depth	560
Net weight (kg)	27.2
Gross weight (kg)	29

## TECHNICAL FEATURES

Automatic programmes	Ne
Maximum temperature for water intake (°C)	60
Start delay options	No delay
Start delay time max. (h)	0
Progress indicator	-
Digital countdown indicator	Ne
Salt light indicator	Ne
Rinse aid light indicator	Ne
Safety device	Yes
Adjustable upper basket	Yes, unloaded
Largest loadable dish upper basket (cm)	0
Largest loadable dish lower basket (cm)	0
Number of place settings	10

## ENERGY LABEL

Energy efficiency class - NEW (2010/30/EU)	A+
Energy consumption annual (kWh/annum) - NEW (2010/30/EU)	238
Duration of the left-on mode - NEW (2010/30/EU)	12
Power consumption in left-on mode - NEW (2010/30/EU)	5
Power consumption in off-mode - NEW (2010/30/EU)	0.5
Water consumption annual (l/annum) - NEW (2010/30/EU)	3220
Noise level (dB(A) re 1 pW)	51