

---

## Contents

**Safety instructionS, 3**

**Safeguarding the environment, 5**

**Setting up your oven, 6**

**Operation instruction, 7**

**Troubleshooting, 11**

**Installation instruction, 12**

# SAFETY INSTRUCTIONS

GB

## IMPORTANT TO BE READ AND OBSERVED

Before using the appliance read these safety instructions.

Keep them for future reference.

These instructions and the appliance itself provide important safety warnings, to be observed at all times.

The manufacturer declines any liability for failure to observe these safety instructions, for inappropriate use of the appliance or incorrect setting of controls.

## SAFETY WARNINGS

Very young (0-3 years) and young children (3-8 years) shall be kept away from the appliance unless continuously supervised. Children from 8 years old and above and persons with reduced physical, sensory or mental capabilities or lack of experience and knowledge can use this appliance only if they are supervised or have been given instructions on safe use and understand the hazards involved. Children must not play with the appliance. Cleaning and user maintenance must not be carried out by children without supervision.

**WARNING:** The appliance and its accessible parts become hot during use, children less than 8 year of age shall be kept away unless continuously supervised.

**WARNING:** Avoid touching heating elements or interior surface - risk of burns.

Never leave the appliance unattended during food drying.

If the appliance is suitable for probe usage, only use the temperature probe recommended for this oven.

**WARNING:** If the door or door seals are damaged, the oven must not be operated until it has been repaired by a competent person.

**WARNING:** Liquids and other foods must not be heated in sealed containers since they are liable to explode.

The microwave oven is intended for heating food and beverages. Drying of food or cloathing and heating of warming pads, slippers, sponges, damp cloth and similar may lead to risk of injury, ignition or fire.

When heating food in plastic or paper containers, keep an eye on the oven due to the possibility of ignition.

Microwave heating of beverages can result in

delayed eruptive boiling, therefore care must be taken when handling the container.

The contents of feeding bottles and baby food jars shall be stirred or shaken and the temperature checked before consumption, in order to avoid burns.

Eggs in their shell and shole hard-boiled eggs should not be heated in microwave ovens since they may explode even after microwave heating has ended.

Only use utensils suitable for use in a microwave oven.

If smoke is emitted switch off or unplug the appliance and keep the door closed in order to stifle any flames.

Do not use your microwave oven for deep-frying, because the oil temperature cannot be controlled.

Keep clothes or other flammable materials away from the appliance, until all the components have cooled down completely. Overheated oils and fats catch fire easily.

Always be vigilant when cooking food rich in fat, oil or when adding alcohol (e.g. rum, cognac, wine) - risk of fire.

Use oven gloves to remove pans and accessories, taking care not to touch the heating elements.

At the end of cooking, exercise caution when opening the door, by letting the hot air or steam exit gradually before accessing the appliance.

Do not obstruct hot air vents at the front of the oven.

## PERMITTED USE

**CAUTION:** The appliance is not intended to be operated by means of an external timer or separate remote controlled system.

This appliance is intended to be used in household and similar applications such as:

- Staff kitchen areas in shops, offices and other working environments;

- Farm houses;

- By clients in hotels, motels and other residential environments;

- Bed and breakfast type environments.

This appliance is solely for domestic, not professional use.

Do not use the appliance outdoors.

Do not store explosive or flammable substances such as aerosol cans and do not place or use gasoline or other flammable materials in or near the appliance: a fire may

break out if the appliance is inadvertently switched on.

No other use is permitted (e.g. heating rooms).

## INSTALLATION

The appliance must be handled and installed by two or more persons. Use protective gloves to unpack and install the appliance.

This appliance is intended to be used built-in. Do not use it freestanding.

Installation and repairs must be carried out by a qualified technician, in compliance with the manufacturer's instructions and local safety regulations. Do not repair or replace any part of the appliance unless specifically stated in the user manual.

Children should not perform installation operations. Keep children away during installation. Keep the packaging materials (plastic bags, polystyrene parts, etc.) out of reach of children, during and after the installation.

After unpacking the appliance, make sure that it has not been damaged during transport. In the event of problems, contact the dealer or your nearest After-sales Service. The appliance must be disconnected from the power supply before any installation operation.

During installation, make sure the appliance does not damage the power cable.

Only activate the appliance when the installation has been completed.

After installation, the bottom of the appliance must no longer be accessible.

Carry out all cabinet cutting works before fitting the appliance in the furniture and carefully remove all wood chips and sawdust. Do not obstruct the minimum gap between the worktop and the upper edge of the oven. Only remove the oven from its polystyrene foam base at the time of installation.

Do not install the appliance behind a decorative door - Risk of fire.

After unpacking the appliance, make sure that the appliance door closes properly.

In the event of problems, contact the dealer or your nearest After-sales Service.

## ELECTRICAL WARNINGS

For installation to comply with current safety regulations, an omnipolar switch with minimum contact gap of 3 mm is required

and the appliance must be earthed.

If the power cable is damaged, replace with an identical one. The power cable must only be replaced by a qualified technician in compliance with the manufacturer instruction and current safety regulations.

Contact an authorized service center.

It must be possible to disconnect the appliance from the power supply by unplugging it if plug is accessible, or by means of an accessible multi-pole switch installed upstream of the socket in conformity with national electrical safety standards.

The rating plate is on the front edge of the oven (visible when the door is open).

In case of replacement of power cable, contact an authorized service center.

If the fitted plug is not suitable for your socket outlet, contact a qualified technician.

The power cable must be long enough to connect the appliance, once fitted in its housing, to the main power supply. Do not pull the power supply cable.

Do not use extension leads, multiple sockets or adapters.

Do not operate this appliance if it has a damaged mains cord or plug, if it is not working properly, or if it has been damaged or dropped. Keep the cord away from hot surfaces.

The electrical components must not be accessible to the user after installation.

Do not touch the appliance with any wet part of the body and do not operate it when barefoot.

## CLEANING AND MAINTENANCE

Never use steam cleaning equipment.

**WARNING:** Ensure that the appliance is switched off before replacing the lamp to avoid the possibility of electric shock.

Do not use harsh abrasive cleaners or sharp metal scrapers to clean the appliance door glass since they can scratch the surface, which may result in shattering of the glass.

**WARNING:** It is hazardous for anyone other than a competent person to carry out any service or repair operation that involves the removal of a cover which give protection against exposure to microwave energy.

Failure to maintain the oven in a clean condition could lead to deterioration of the surface that could adversely affect the life of

the appliance and possibly result in a hazardous situation.  
The oven shall be cleaned regularly and any food deposits removed.  
Wear protective gloves for cleaning and maintenance.

The appliance must be disconnected from the power supply before any maintenance operation.  
Ensure the appliance is cooled down before carrying out any cleaning or maintenance operation.

## SAFEGUARDING THE ENVIRONMENT

### DISPOSAL OF PACKAGING MATERIALS

The packaging material is 100% recyclable and is marked with the recycle symbol . The various parts of the packaging must therefore be disposed of responsibly and in full compliance with local authority regulations governing waste disposal.

### SCRAPPING OF HOUSEHOLD APPLIANCES

When scrapping the appliance, make it unusable by cutting off the power cable and removing the doors and shelves (if present) so that children cannot easily climb inside and become trapped.

This appliance is manufactured with recyclable  or reusable materials. Dispose of it in accordance with local waste disposal regulations.

For further information on the treatment, recovery and recycling of household electrical appliances, contact your competent local authority, the collection service for household waste or the store where you purchase the appliance.

This appliance is marked in compliance with European Directive 2012/19/EU, Waste Electrical and Electronic Equipment (WEEE).

By ensuring this product is disposed of correctly, you will help prevent potential negative consequences for the environment and human health, which could otherwise be caused by inappropriate waste handling of this product.



The symbol  on the product or on the accompanying documentation indicates that it should not be treated as domestic waste but must be taken to an appropriate collection center for the recycling of electrical and electronic equipment.

# SETTING UP YOUR OVEN

GB

## Names of Oven Parts and Accessories

Remove the oven and all materials from the carton and oven cavity.

Your oven comes with the following accessories:

Glass tray	1
Turntable ring assembly	1
Instruction Manual	1

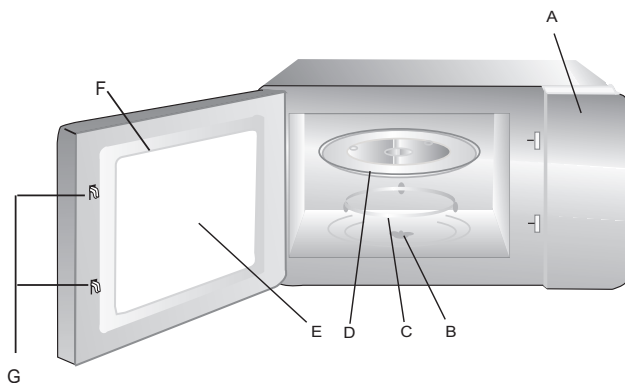

- A) Control panel
- B) Turntable shaft
- C) Turntable ring assembly
- D) Glass tray
- E) Observation window
- F) Door assembly
- G) Safety interlock system

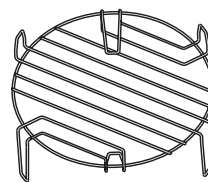
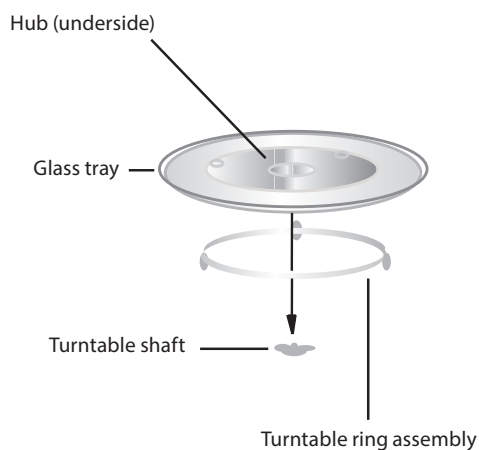

Grill Rack (Only for Grill series)

**There are a number of accessories available on the market. Before you buy, ensure they are suitable for microwave use and resistant to oven temperatures.**

**Metallic containers for food or drink should never be used during microwave cooking.**

**Always ensure that foods and accessories do not come into contact with the inside walls of the oven.**





**Always ensure that the turntable is able to turn freely before starting the oven. Take care not to unseat the turntable whilst inserting or removing other accessories.**

# OPERATION INSTRUCTION

GB

## 1. Clock Setting





When the microwave oven is ON, the oven will display "0:00", buzzer will ring once.

- 1) Press "" once. "00:00" displays.
- 2) Turn "" to adjust the hour figures, the input time should be within 0--23 (24-hour).
- 3) Press "", the minute figures will flash.
- 4) Turn "" to adjust the minute figures, the input time should be within 0--59.
- 5) Press "" to finish clock setting. "." will flash.

**Note:** 1) If the clock is not set, it would not function when powered.  
2) During the process of clock setting, if you press "", the oven will go back to the previous status automatically.







## 2. Microwave Cooking

Press "" the screen will display "P100".





Press "" different times or turn "" to choose the power you want, and "P100", "P80", "P50", "P30" or "P10" will display for each added press. Then press "" to confirm, and turn "" to set cooking time from 0:05 to 95:00.

Press "" again to start cooking.







Example: If you want to use 80% microwave power to cook for 20 minutes, you can operate the oven as the following steps.

- 1) Press "" once, the screen display "P100".
- 2) Press "" once again or turn "" to choose 80% microwave power.
- 3) Press "" to confirm, and the screen displays "P 80".
- 4) Turn "" to adjust the cooking time until the oven displays "20:00".
- 5) Press "" to start cooking.

## 3. Grill or Combi. Cooking





Press "" the screen will display "P100", and press the same button different times or turn the "" to choose the power you want, and "G", "C-1" or "C-2" will display for each added press. Then press "" to confirm, and turn "" to set cooking time from 0:05 to 95:00. Press "" again to start cooking.

Example: If you want to use 55% microwave power and 45% grill power(C-1) to cook for 10 minutes, you can operate the oven as the following steps.



- 1) Press "" once, the screen display "P100".
- 2) Press "" different times or turn "" to choose combi. Model 1.
- 3) Press "" to confirm, and the screen displays "C-1".
- 4) Turn "" to adjust the cooking time until the oven displays "10:00".
- 5) Press "" to start cooking.

**Note:** When half the grill time has passed the oven sounds twice: this is normal. In order to have a better effect of grilling food, you should turn the food over and close the door, and then press "" to continue cooking. If no operation, the oven will continue working.

## 4. Quick Start

- 1) In waiting state, press "" to start cooking with 100% power, each added press will increase 30 seconds cooking time up to 95 minutes.
- 2) In microwave cooking or time defrost state, each press of "" can increase 30 seconds of cooking time.
- 3) In waiting state, turn "" left to set cooking time with 100% microwave power, then press "" to start cooking.





## 5. Defrost By Weight

- 1) Press "" once, and the oven will display "dEF1".
- 2) Turn "" to select the weight of food from 100 to 2000 g.
- 3) Press "" to start defrosting.





### " Pad instructions

Order	Display	Microwave Power	Grill Power
1	P100	100%	
2	P80	80%	
3	P50	50%	
4	P30	30%	
5	P10	10%	
6	G	0%	100%
7	C-1	55%	45%
8	C-2	36%	64%

#### 6. Defrost By Time



- 1) Press "/ 
 twice, and the oven will display "dEF2".
  - 2) Turn " to select the defrost time. The MAX time is 95 minutes.
  - 3) Press " to start defrosting.
- The defrost power is P30 , and it will not be changed.

#### 7. Kitchen Timer









- 1) Press "/ 
 twice, screen will display 00:00.
- 2) Turn " to enter the correct time. (The maximum cooking time is 95 minutes.)
- 3) Press " to confirm setting.
- 4) When the kitchen time is reached, timer indicator will go out. The buzzer will ring 5 times.  
If the clock be set (24-hour system), screen will display the current time.

**Note:** The kitchen Time is just a timer: it only has the "alarm clock" function.

#### 8. Inquiring Function

- 1) In states of microwave, grill and combination cooking, press "", the current power will be displayed for 3 seconds. After 3 seconds, the oven will turn back to the former state.
- 2) In cooking state, press "/ 
 to inquire the time and the time will display for 3 seconds.







#### 9. Auto Menu

- 1) Turn " right to choose the menu, and "A-1" to "A- 10" will display.
  - 2) Press " to confirm.
  - 3) Turn " to choose the default weight as the menu chart.
  - 4) Press " to start cooking.
- Example: If you want to use "Auto Menu" to cook fish for 350g.
- 1) Turn " clockwise till "A-4" display.
  - 2) Press " to confirm.
  - 3) Turn " to select the weight of fish till "350" display.
  - 4) Press " to start cooking.

#### 10. Multi-section cooking

At most 2 sections can be set for cooking. In multi-section cooking, if one section is defrosting, then defrosting shall be placed in the first section.

Example: If you want to defrost food for 5 minutes and then cook with 80% microwave power for 7 minutes, operate it as the following:

- 1) Press "/ 
 twice, and the oven will display "dEF2".
- 2) Turn " to select the defrost time till "5:00" display.
- 3) Press " once, the screen display "P100".
- 4) Press " once again or turn " to choose 80% microwave power.



---

5) Press "  " to confirm, and the screen displays "P 80".

---

6) Turn "  " to adjust the cooking time till the oven displays "7:00".

---

7) Press "  " to start cooking, and buzzer will sound once for the first section, defrosting time counts down; buzzer will sound once again entering the second cooking. When cooking finish, buzzer sounds five times.

### 11. Lock-out Function for Children

Lock: In waiting state, press "  " for 3 seconds, there will be a long beep denoting entering the childrenlock state and current time will display if the time has been set, otherwise, the screen will display "  ".

Lock quitting: In locked state, press "  " for 3 seconds, there will be a long "beep" denoting that the lock is released.

**The menu chart:**

<b>Menu</b>	<b>Weight (g)</b>	<b>Display</b>
A-1 Pizza	200 g	200
	400 g	400
A-2 Potato	200 g	200
	400 g	400
	600 g	600
A-3 Meat	250 g	250
	350 g	350
	450 g	450
A-4 Fish	250 g	250
	350 g	350
	450 g	450
A-5 Vegetable	200 g	200
	300 g	300
	400 g	400
A-6 Beverage	1 cup (120 ml)	1
	2 cups (240 ml)	2
	3 cups (360 ml)	3
A-7 Pasta	50 g (with 450 ml cold water)	50
	100 g (with 800 ml cold water)	100
A8 Popcorn	50 g	50
	100 g	100
A-9 Chicken	400	400
	800	800
	1200	1200
A-10 Reheat	200	200
	400	400
	600	600

# TROUBLESHOOTING

GB

Trouble	Possible Cause	Remedy
The oven is not working.	Power cut. Disconnection from the mains cut.	Check for the presence of mains electrical power and whether the oven is connected to the electricity supply. Turn off the oven and restart it to see if the fault persists.
Oven does not heat.	Door not closed	Close door

## HOW TO OBTAIN THE USE AND CARE GUIDE

>  [www](http://www.docs.indesit.eu) Download the Use and Care Guide from our website **docs.indesit.eu** (you can use this QR Code), specifying the product's commercial code.



> Alternatively, contact our Client After-sales Service.

## CONTACTING OUR AFTER-SALES SERVICE

You can find our contact details in the warranty manual. When contacting our Client After-sales Service, please state the codes provided on your product's identification plate.

