

Instructions for use

KitchenAid

Important safety instructions	4
Installation	8
Safeguarding the environment	9
ECO design declaration	9
Troubleshooting Guide	9
After-Sales Service	10
Cleaning	10
Maintenance	11
Instructions for oven use	12
Functions description	17
Cooking table	18
Recommended use and tips	19

Important safety instructions

YOUR SAFETY AND THAT OF OTHERS IS VERY IMPORTANT

This manual and the appliance itself provide important safety warnings, to be read and observed at all times.



This is the danger symbol, pertaining to safety, which alerts users to potential risks to themselves and others. All safety warnings are preceded by the danger symbol and the following terms:



DANGER

Indicates a hazardous situation which, if not avoided, will cause serious injury.



WARNING

Indicates a hazardous situation which, if not avoided, could cause serious injury.

All safety warnings give specific details of the potential risk present and indicate how to reduce risk of injury, damage and electric shock resulting from improper use of the appliance. Carefully observe the following instructions:

- Use protective gloves to perform all unpacking and installation operations.
- The appliance must be disconnected from the power supply before carrying out any installation work.
- Installation and maintenance must be carried out by a qualified technician, in compliance with the manufacturer's instructions and local safety regulations. Do not repair or replace any part of the appliance unless specifically stated in the user manual.
- Power cable replacement must be carried out by a qualified electrician. Contact an authorised service centre.
- Regulations require that the appliance is earthed.
- Once the appliance is fitted in its housing, the power

cable must be long enough to connect the appliance to the main power supply.

- For installation to comply with current safety regulations, an all-pole disconnect switch with minimum contact gap of 3 mm must be used.
- Do not use multiple plug adaptors if the oven is fitted with a plug.
- Do not use extension leads.
- Do not pull the power supply cable.
- The electrical components must not be accessible to the user after installation.
- If the surface of the induction plate is cracked, do not use it and switch off the appliance to avoid the possibility of electric shock (only for models with induction function).
- Do not touch the appliance with any wet part of the body and do not operate it when barefoot.
- This appliance is designed solely for use as a domestic appliance for cooking food. No other type of use is permitted (e.g.: heating rooms).
The manufacturer declines all responsibility for inappropriate use or incorrect setting of the controls.
- The appliance and its accessible parts become hot during use.
- Care should be taken to avoid touching heating elements.
- Very young (0-3 years) and young children (3-8 years) shall be kept away unless continuously supervised.
- Children of 8 years and above and persons with reduced physical, sensory or mental capabilities or lack of experience and knowledge, can use this appliance

only if they are supervised or have been given instructions on safe appliance use and understand the hazards involved. Children must not play with the appliance. Cleaning and user maintenance must not be performed by children without supervision.

- During and after use, do not touch the heating elements or interior surfaces of the appliance – risk of burns. Do not allow the appliance to come into contact with cloths or other flammable materials until all the components have cooled down completely.
- At the end of cooking, exercise caution when opening the appliance door, letting the hot air or steam exit gradually before accessing the oven. When the appliance door is shut, hot air is vented from the aperture above the control panel. Do not obstruct the vent apertures.
- Use oven gloves to remove pans and accessories, taking care not to touch the heating elements.
- Do not place flammable materials in or near the appliance: a fire may break out if the appliance is inadvertently switched on.
- Do not heat or cook sealed jars or containers in the appliance.
- The pressure that builds up inside might cause the jar to explode, damaging the appliance.
- Do not use containers made of synthetic materials.
- Overheated oils and fats catch fire easily. Always remain vigilant when cooking foods rich in fat and oil.
- Never leave the appliance unattended during food drying.
- If alcoholic beverages are used when cooking foods

(e.g. rum, cognac, wine), remember that alcohol evaporates at high temperatures. As a result, there is a risk that vapours released by the alcohol may catch fire upon coming into contact with the electrical heating element.

- Never use steam cleaning equipment.
- Do not touch the oven during the pyrolysis cycle. Keep children away from the oven during the pyrolysis cycle. Any excess spillage must be removed from the oven cavity before the cleaning cycle (only for ovens with Pyrolysis function).
- During and after the pyrolysis cycle, the animals have to be kept away from the area of the appliance location (only for ovens with Pyrolysis function).
- Use only the temperature probe recommended for this oven.
- Do not use harsh abrasive cleaners or sharp metal scrapers to clean the oven door glass as they can scratch the surface, which may result in the glass shattering.
- Ensure that the appliance is switched off before replacing the lamp to avoid the possibility of electric shock.
- Do not use aluminium foil to cover food in the cooking vessel (only for ovens with a cooking vessel supplied).

SCRAPPING OF HOUSEHOLD APPLIANCES

- This appliance is manufactured with recyclable or reusable materials. Scrap the appliance in accordance with local regulations on waste disposal. Before scrapping, cut off the power cords so that the appliances cannot be connected to the mains.
- For further information on the treatment, recovery and recycling of household electrical appliances, contact your competent local authority, the collection service for household waste or the store where you purchased the appliance.

Installation

After unpacking the oven, make sure that it has not been damaged during transit and that the oven door closes properly.

In the event of problems, contact the dealer or your nearest After-Sales Service. To avoid any damage, only remove the oven from its polystyrene foam base at the time of installation.

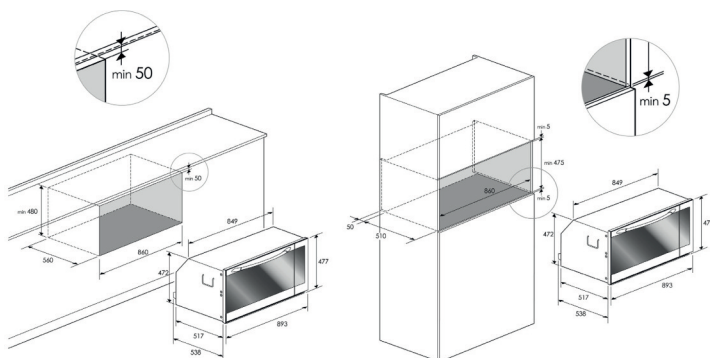

Preparing the housing unit

- Kitchen units in contact with the oven must be heat resistant (min 90°C).
- Carry out all cabinet cutting work before fitting the oven in the housing and carefully remove all wood chips and sawdust.
- After installation, the bottom of the oven must no longer be accessible.
- For correct appliance operation, do not obstruct the minimum gap between the worktop and the upper edge of the oven.

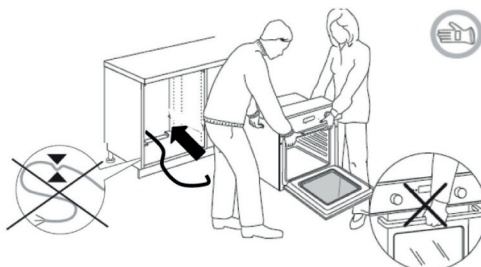

Electrical connection

Make sure the power voltage specified on the appliance dataplate is the same as the mains voltage. The dataplate is on the front edge of the oven (visible when the door is open).

- Power cable replacement (type H05 RR-F 3 x 1.5 mm²) must be carried out by a qualified electrician. Contact an authorized service centre.

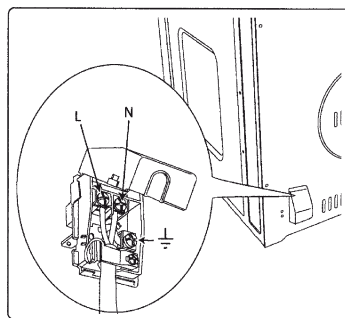

GENERAL RECOMMENDATIONS

Before use:

- Remove cardboard protection pieces, protective film and adhesive labels from the oven and the accessories.
- Remove the accessories from the oven and heat it at 200°C for about an hour to eliminate the smell and fumes from the protective grease and insulating materials.

During use:

- Do not place heavy objects on the door as they could damage it.
- Do not cling to the door or hang anything from the handle.
- Do not cover the inside of the oven with aluminium foil.
- Do not pour water into the inside of a hot oven; this could damage the enamel coating.
- Do not drag pots or pans across the bottom of the oven as this could damage the enamel coating.
- Make sure that the electrical cables of other appliances do not touch hot parts of the oven or become trapped in the door.
- Do not expose the oven to atmospheric agents.

Safeguarding the environment

Disposal of packing materials

- The packaging materials are 100% recyclable and are marked with the recycling symbol .
- The various parts of the packing must therefore be disposed of responsibly and in full compliance with local authority regulations governing waste disposal.



Appliance scrapping

- This appliance is marked according to the European Directive 2012/19/EU, Waste Electrical and Electronic Equipment (WEEE).
- By ensuring correct disposal of the product, the user can help prevent potential negative consequences for the environment and human health.

ECO design declaration

This appliance meets the eco design requirements of European regulations n. 65/2014 and n. 66/2014 in conformity to the European standard EN 60350-1.

Troubleshooting Guide

The oven does not work:

- Check for the presence of mains electrical power and if the oven is connected to the electrical supply.
- Switch the oven off and then on again to see if the fault has been eliminated.



- The symbol  on the product or on the accompanying documentation indicates that it should not be treated as domestic waste but must be taken to an appropriate collection centre for the recycling of electrical and electronic equipment.

Energy saving tips

- Only preheat the oven if specified in the cooking table or your recipe.
- Use dark lacquered or enamelled baking moulds as they absorb heat far better.

After-Sales Service

Before contacting the After-Sales Service:

1. See if you can solve the problem yourself with the help of the suggestions given in the "Troubleshooting guide".
2. Switch the appliance off and then on again to see if the problem has been eliminated.

If the fault persists after the above checks, contact the nearest After-Sales Service.

Always specify:

- a brief description of the fault;
- the type and exact model of the oven;
- the service number (number after the word Service on the rating plate), located on the right

hand edge of the oven cavity (visible when the oven door is open). The service number is also indicated on the guarantee booklet;

- your full address;
- your telephone number.

SERVICE 0000 000 00000



If any repairs are required, contact an **authorized Service Centre** (to guarantee the use of original spare parts and correct repair).

Cleaning

! WARNING

- Do not use steam cleaners.
- Only clean the oven when it is cool to the touch.
- Disconnect the appliance from the mains power supply.

Oven exterior

IMPORTANT: do not use corrosive or abrasive detergents. If any of these products unintentionally comes into contact with the appliance, clean immediately with a damp microfibre cloth.

- Clean the surfaces with a damp microfibre cloth. If it is very dirty, add a few drops of washing up detergent to the water. Finish off with a dry cloth.

Oven interior

IMPORTANT: do not use abrasive sponges or metallic scrapers or scourers. Over time, these can ruin enamelled surfaces and the oven door glass.

- After every use, allow the oven to cool then clean it preferably while it is still warm in order to remove built-up dirt and stains caused by food residues (e.g. food with a high sugar content).
- Do not use corrosive or abrasive detergents.
- Clean the door glass with a suitable liquid detergent. The oven door can be removed to facilitate cleaning (see MAINTENANCE).

N.B: during prolonged cooking of foods with a high water content (e.g. pizza, vegetables, etc.) condensation may form on the inside of

the door and around the seal. When the oven is cold, dry the inside of the door with a cloth or sponge.

Accessories:

- Soak the accessories in water with washing up detergent immediately after use, handling them with oven gloves if still hot.
- Food residues can be easily removed using a washing-up brush or sponge.

SELF-CLEANING CATALYTIC PANELS (if present)

These special panels are simply hooked on to the walls before the side frames are fitted. They are coated in a special, micro-porous catalytic enamel which oxidises and gradually vaporises splashes of grease and oil at cooking temperatures above 200° C.

If the oven is not clean after cooking fatty foods, operate the empty oven for 60 minutes (max.) at maximum temperature.

Never wash or clean selfcleaning panels with abrasive, acid, or alkaline products.

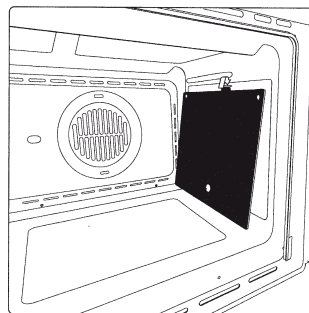

Maintenance

WARNING

- Use safety gloves.
- Ensure the oven is cold before carrying out the following operations.
- Disconnect the appliance from the mains power supply.

REMOVING THE DOOR

To remove the door:

1. Open the door fully.
2. Lower the catches and push them forwards as far as they will go (fig. 1).
3. Close the door as far as it will go (A), lift it up (B) and turn it (C) until it is released (D) (fig. 2).

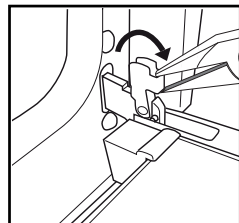

(fig. 1)

To refit the door:

1. Insert the hinges in their seats.
2. Open the door fully.
3. Lift the two catches.
4. Close the door.

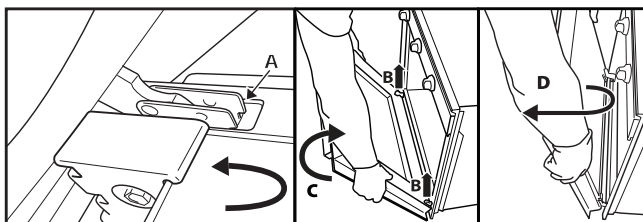

(fig. 2)

REMOVING THE SIDE GRILLES

To press down the grilles and lift up as shown in fig. 3.

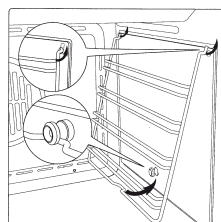

(fig. 3)

REPLACING THE OVEN LAMP

To replace the two rear lamps (fig. 4):

1. Disconnect the oven from the power supply.
2. Unscrew the lamp cover (Fig. 5), replace the lamp (see note for lamp type) and screw the lamp cover back on.
3. Reconnect the oven to the power supply.

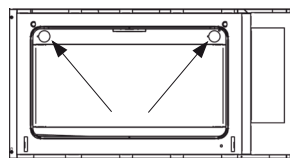

(fig. 4)

N.B:

- Only use 25W / 230V type E14, T300°C incandescent lamps.
- The lamp used in the appliance is specifically designed for electrical appliances and is not suitable for household room illumination (Commission Regulation (EC) No 244/2009).
- Lamps are available from our After-sales Service.

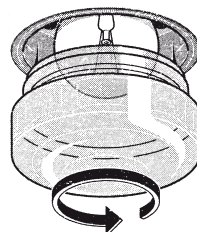

(fig. 5)

Instructions for oven use

FOR ELECTRICAL CONNECTION, SEE THE PARAGRAPH ON INSTALLATION

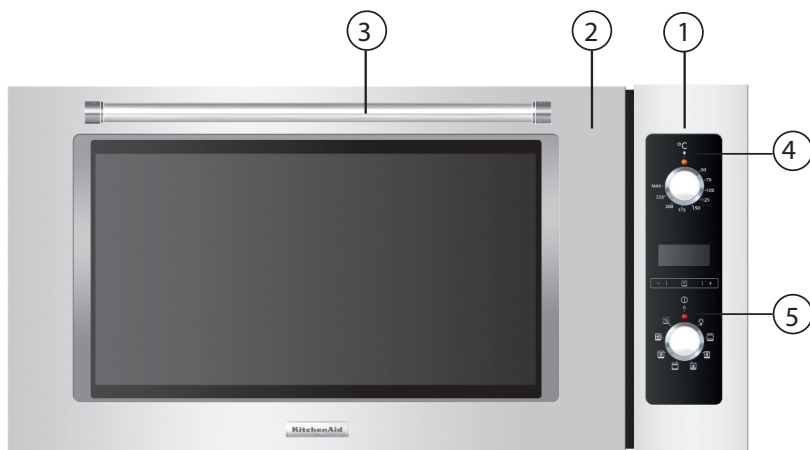

- 1. Control panel
- 2. Oven door
- 3. Oven handle
- 4. Thermostat indicator light
- 5. Oven function indicator light

N.B:

- During cooking, the cooling fan may switch on at intervals in order to minimise energy consumption.
- At the end of cooking, after the oven has been switched off, the cooling fan may continue to run for a while.
- When the oven door is opened during cooking, the heating elements switch off.

ACCESSORIES SUPPLIED

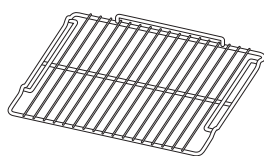

Fig. A

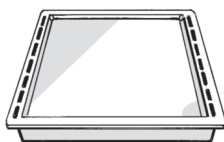

Fig. B



Fig. C

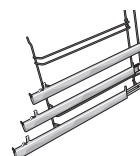

Fig. D

- A. WIRE SHELF:** the wire shelf can be used to grill food or as a support for pans, cake tins and other ovenproof cooking receptacles.
 - B. DRIP TRAY:** designed to collect fat and food particles when it is positioned under the grid or as a plate, such as when cooking meat, chicken, and fish with or without vegetables. Pour a little water into the drip tray to prevent spatters of fat or oil and smoke.
 - C. TURNSPIT:** for grilling poultry and roasts.
 - D. SLIDING RAILS:** to facilitate insertion and removal of accessories.
- The number of accessories may vary according to which model is purchased.**

ACCESSORIES NOT SUPPLIED

Can be purchased separately from the After-sales Service.

Instructions for oven use

INSERTING WIRE SHELVES AND OTHER ACCESSORIES IN THE OVEN

The wire shelf and other accessories are provided with a locking mechanism to prevent their unintentional removal.

1. Insert the wire shelf horizontally, with the raised part "A" upwards (fig. 1).
2. Angle the wire shelf when it reaches the locking position "B" (fig. 2).
3. Return the wire shelf to the horizontal position and push it in fully to "C" (fig. 3).
4. To remove the wire shelf proceed in reverse order.

The other accessories, like the drip tray is inserted in exactly the same way. The protrusion on the flat surface enables the accessories to lock in place.

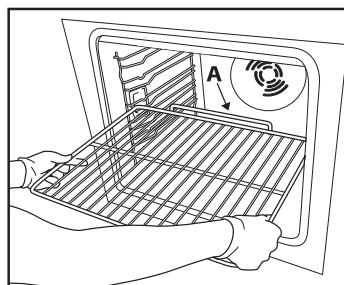

(Fig. 1)

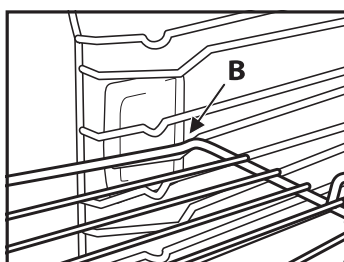

(Fig. 2)

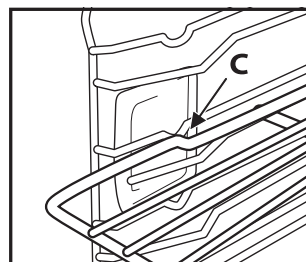

(Fig. 3)

SLIDING RUNNERS

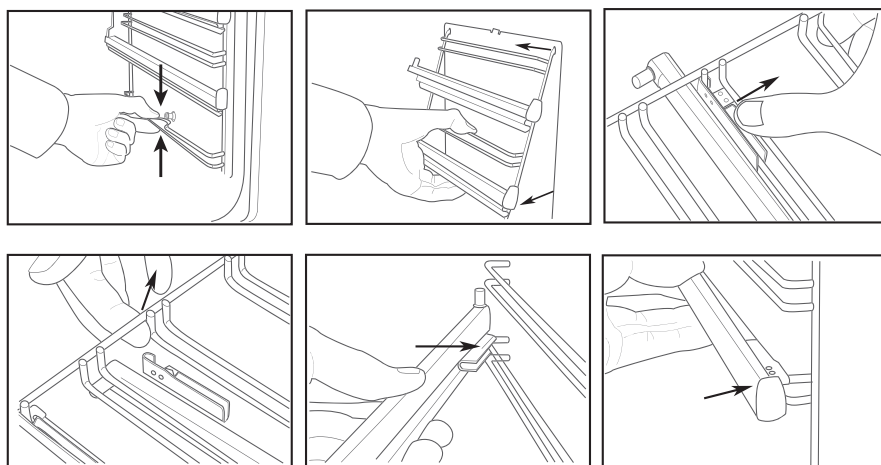

Using the turnspit

Put turnspit rod **A** into the drive unit and the groove **B** into the bend **C**.

Turn the plastic handle **D** anticlockwise.

Slide the shelf into the oven runners ensuring that the rod slots into hole **F**.

The turnspit shelf must always be fitted in the middle of the oven (second position from bottom).

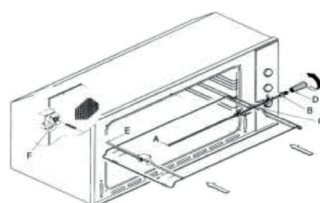

Instructions for oven use

CONTROL PANEL DESCRIPTION

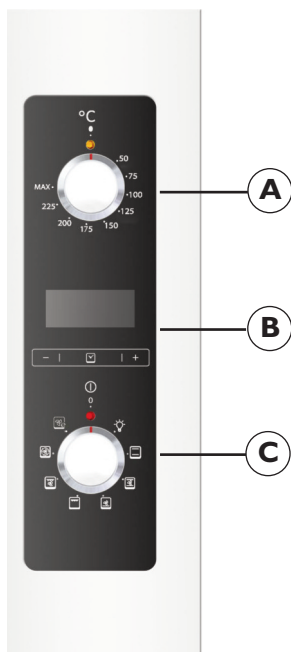

A. Thermostat temperature selection knob.

Use the thermostat to set the cooking temperature you need. The thermostat can be adjusted from 50°C to 250 °C.

B. Touch control.

Use to select:

- Clock setting
- Minute minder
- Cooking time
- End of cooking time
- Programming automatic cooking
- Acoustic signal adjustment

C. Function selection knob, clockwise.

0 OFF

- Oven light
- Conventional
- Convection Bake
- Bottom + fan
- Grill
- Turbo Grill
- Forced Air
- Eco Mode (Forced Air)

Note: Defrost is possible with all fan functions, leaving the thermostat temperature selection knob to 0°C.

LIST OF FUNCTIONS

0 OFF



Oven light (stays on while oven is in use).



Top and bottom heating elements. Thermostat setting from 50°C to MAX.



Top and bottom heating elements with fan. Thermostat setting from 50°C to MAX.



Bottom heating element with fan. Thermostat setting from 50°C to MAX.



Top heating elements (small, low power grill). Thermostat setting from 50°C to 200°C.



Double top heating element with fan (large area grill).
Thermostat setting from 50°C to 200°C.



Circular heating element with fan. Thermostat setting from 50°C to MAX.



This mode is intended to save energy. Ideal for frozen or precooked food, and small portions meals. The preheat time is very short and cooking tends to be slower. It is not recommended for large portions or big meal preparations.

Instructions for oven use

TIMER TOUCH CONTROL

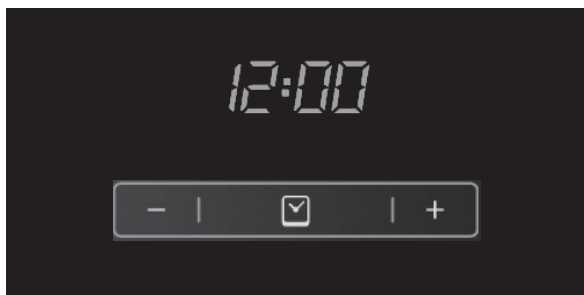

Setting the clock



Figure 1

“Auto” and “0:00” will start flashing when the unit is switched on for the first time. To set the clock, press the central button for about 3 seconds. When  appears, press “+” or “-” to set the correct time. Wait until a beep tells you that the clock has been set (**figure 1**).

To set the time at a later stage, press “+” and “-” together for 3 seconds and then adjust the clock as described above.

Minute minder



Figure 2

As this minute counter does not control the oven, when it finishes counting the oven will continue to work.

To set, press the central button for 3 seconds until  appears (**figure 2**). Press “+” and “-” to set the required time.

To set the minute counter at a later stage, press the central button for 3 seconds and adjust as described above.

The minute counter beeps when it finishes counting. To disable it, press any button.

Cooking time



Figure 3

This is a semi-automatic cooking function. It can be used to set cooking times.

Press the central button for 3 seconds. Then press it again until “dur” appears (**figure 3**). Press “+” and “-” to set the required cooking time.

End of cooking time



Figure 4

The end of cooking time can also be set.

Press the central button for 3 seconds. Press the central button twice consecutively and wait for “End” to appear (**figure 4**). Press “+” and “-” to set the required end of cooking time.

The oven will work in the set mode and at the set temperature until the end of cooking time.

Instructions for oven use

Programming automatic cooking



Figure 5

Cooking function with set times.

Press the central button for 3 seconds. Then press it again until “dur” appears. Press “+” and “-” to set the required cooking time. Wait a few seconds for the setting to be memorised.

Press the central button for 3 seconds. Press it another two times and wait for “End” to appear (**figure 4**). Press “+” and “-” to set the required end of cooking time.

E.g.:

Current time: 12.30

Cooking time: 10 minutes

End of cooking time: 14.00

The oven will start cooking at 13.50 (14.00 less 00.10) at the set temperature and in the set mode and will stop at 14.00

The oven will beep when it stops cooking. To disable it, press any button.

Acusting signal adjustment



To adjust beep volume, press “+” and “-” together. Then press the central button and wait for “ton1” (high volume) to flash. Press “-” to select “ton2” (medium volume) or “ton3” (low volume).

Press the central button to set the selected volume.

Functions description

CONVENTIONAL COOKING

Conventional cooking uses top and bottom heat to cook a single dish.

Place the food in the oven only once cooking temperature has been reached, i.e. when the heating indicator goes out.

If you want to increase top or bottom temperature towards the end of the cooking cycle, set the temperature control to the right position. It is advisable to open the oven door as little as possible during cooking.

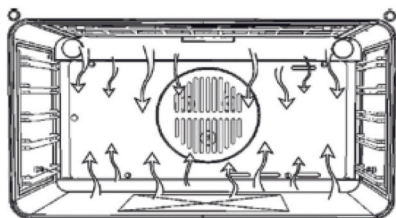

FAN COOKING

For this type of cooking a fan positioned at the back allows the circulation of hot air inside the oven, creating uniform heat. In this way cooking is more rapid than conventional cooking. It is a suitable method for cooking dishes on more than one shelf, especially when the food is of different types (fish, meat etc.)

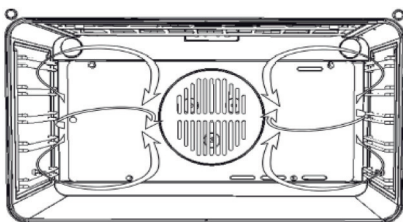

DEFROSTING

By selecting one of the fan cooking functions and setting the thermostat to zero, the fan allows cold air to circulate inside the oven. In this way frozen food can be rapidly defrosted.

GRILL COOKING

Use the grill to grill or brown foods.

Some ovens may be equipped with an electric motor, spit and skewers for turning on the spit.

Place the shelf with the food to be cooked in the 1st or 2nd position from the top.

Pre-heat the oven for 5 minutes.

Turn the thermostat to a temperature between 50° and 200°.

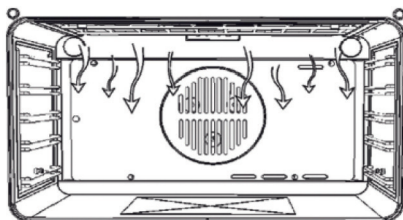

COOLING FAN

The fan is positioned on the upper part of the oven and create a circle of cooling air on the inside of the furniture and through the door of the oven.















It is turned on when the temperature of the outer shell of the oven reaches 60°C.

















By switching on the oven with the thermostat at 200°C the fan starts working after approx. 10 min.

It is turned off when the temperature of the outer shell of the oven descends under 60°C.

By switching off the oven with the thermostat at 200°C the fan stops working after approx. 30 min.

Cooking table

Recipe	Function	Temperature (°C)	Shelf (from bottom)	Time (min)
		160-200	2-3	30-50
		160-180	2	20-40
		140-160	2	10-40
		140-160	2	25-55
		200-230	1-3	10-20
		210-220	2	45-60
		160-180	2-3	45-60
		190	2-3	60-70
		230-250	4-5	14-18

Recipe	Function	Temperature (°C)	Shelf (from bottom)	Time (min)
		225-250	2	120-105
		160-180	2	120-160
		160-180	2	135-175
		210-230	2	90-120
		160-190	2	90-120
		160-190	2	105-135
		200-220	2-3	50-60
		160-180	2	45-60
		175-190	2	60-70
		175-190	2	75-85
		190-210	2	40-50
		170-190	3	40-50

Recommended use and tips

How to read the cooking table

The table indicates the best function to use for any given food, to be cooked on one or more shelves at the same time. Cooking times start from the moment food is placed in the oven, excluding pre-heating (where required). Cooking temperatures and times are purely for guidance and will depend on the amount of food and type of accessory used. Use the lowest recommended values to begin with and, if the food is not cooked enough, then move on to higher values. Use the accessories supplied and preferably dark coloured metal cake tins and oven trays. You can also use pans and accessories in pyrex or stoneware, but bear in mind that cooking times will be slightly longer. To obtain best results, carefully follow the advice given in the cooking table for the choice of accessories (supplied) to be placed on the various shelves.

Cooking different foods at the same time

Using the "FORCED AIR" function, you can cook different foods which require the same cooking temperature at the same time (for example: fish and vegetables), using different shelves. Remove the food which requires less cooking time and leave food which requires longer cooking time in the oven.

Desserts

- Cook delicate desserts with the conventional function on one shelf only. Use dark coloured metal cake tins and always position them on the wire shelf supplied. To cook on more than one shelf, select the forced air function and stagger the position of the cake tins on the shelves, aiding optimum circulation of the hot air.
- To check whether a raising cake is cooked, insert a wooden toothpick into the centre of the cake. If the toothpick comes out clean, the cake is ready.
- If using non-stick cake tins, do not butter the edges as the cake may not rise evenly around the edges.
- If the cake "sinks" during cooking, set a lower temperature the next time, perhaps reducing the amount of liquid in the mixture and mixing more gently.
- For sweets with moist fillings (cheesecake or fruit pies) use the "CONVECTION BAKE" function. If the base of the cake is soggy, lower the shelf and sprinkle the bottom of the cake with breadcrumbs or biscuit crumbs before adding the filling.

Meat

- Use any kind of oven tray or pyrex dish suited to the size of the piece of meat being cooked. For roast joints, it is best to add some stock to the bottom of the dish, basting the meat during cooking for added flavour. When the roast is ready, let it rest in the oven for another 10-15 minutes, or wrap it in aluminium foil.
- When you want to grill meat, choose cuts with an even thickness all over in order to achieve uniform cooking results. Very thick pieces of meat require longer cooking times. To prevent the meat from burning on the outside, lower the position of the wire shelf, keeping the food farther away from the grill. Turn the meat two thirds of the way through cooking.

To collect the cooking juices it is advisable to place a drip-tray with half a litre of water directly under the grill on which the meat is placed. Top-up when necessary.

Turnspit (only in some models)

Use this accessory to evenly roast large pieces of meat and poultry. Place the meat on the turnspit rod, tying it with string if chicken, and check that it is secure before inserting the rod in the seat located on the front wall of the oven and resting it on the respective support. To prevent smoke and to collect cooking juices, it is advisable to place a drip-tray with half a litre of water on the first level. The rod has a plastic handle which must be removed before starting to cook, and used at the end of cooking to avoid burns when taking the food out of the oven.

Pizza

Lightly grease the trays to ensure the pizza has a crispy base. Scatter the mozzarella over the pizza two thirds of the way through cooking.



FOR THE WAY IT'S MADE.

Printed in Italy

05/19

400011372207

EN