

AKT 8601 IX

12NC: 859991552900

GTIN (EAN) code: 8003437233302

Whirlpool

SENSING THE DIFFERENCE

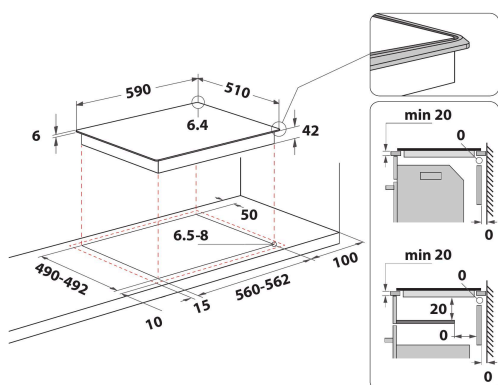

MAIN FEATURES

Product group	Ploča za kuhanje
Construction type	Ugradbeni
Type of control	Electronic
Type of control settings	-
Number of gas burners	0
Number of electric cooking zones	4
Number of electric plates	0
Number of radiant plates	4
Number of halogen plates	0
Number of induction plates	0
Number of electric warming zones	0
Location of control panel	Front
Basic surface material	Glass - inox frame
Main colour of product	Crna
Electrical connection rating (W)	5500
Gas connection rating (W)	0
Gas type	-
Current (A)	24
Voltage (V)	220-240/380-415
Frequency (Hz)	50/60
Length of Electrical Supply Cord (cm)	0
Plug type	Ne
Gas connection	-
Width of the product	590
Height of the product	46
Depth of the product	510
Minimum niche height	42
Minimum niche width	560
Niche depth	490
Net weight (kg)	7.6
Automatic programmes	Ne

TECHNICAL FEATURES

Power on indicator	Yes
Number of indicators	4
Type of regulation	Radiant
Type of lid	Without
Residual heat indicator	Separate
Main on/off switch	Yes
Safety device	-
Timer	Yes

ENERGY LABEL

Energy input

Electric