

Health & Safety, Use & Care and Installation guide



www.whirlpool.eu/register



ENGLISH 3

ENGLISH

HEALTH & SAFETY, USE & CARE

and INSTALLATION GUIDES



THANK YOU FOR BUYING A WHIRLPOOL PRODUCT.

In order to receive a more complete assistance,
please register your appliance on www.whirlpool.eu/register

Index

Health and Safety guide

SAFETY INSTRUCTIONS	5
SAFEGUARDING THE ENVIRONMENT	8
DECLARATION OF CONFORMITY	9

Use and Care guide

PRODUCT DESCRIPTION	10
APPLIANCE	10
CONTROL PANEL	10
DOOR	11
DRUM LIGHT (if available)	11
AVAILABLE ACCESSORIES	11
HOW TO USE THE APPLIANCE	12
FIRST TIME USE	12
DAILY USE	13
PROGRAMMES	15
OPTIONS	18
FUNCTIONS	19
INDICATORS	21
ENERGY SAVING	22

CLEANING & MAINTENANCE	23
EMPTYING THE WATER TANK.....	23
CLEANING THE DOOR FILTER	24
CLEANING THE BOTTOM FILTER.....	25
CLEANING THE OUTSIDE OF THE DRYER.....	27
REVERSING THE DOOR STOP.....	28
TROUBLESHOOTING GUIDE & AFTER-SALES SERVICE	33
FAILURE INDICATOR AND MESSAGES.....	35
TRANSPORT AND HANDLING.....	37
AFTER-SALES SERVICE.....	38
<i>Installation guide</i>	39

SAFETY INSTRUCTIONS

IMPORTANT TO BE READ AND OBSERVED

Before using the dryer carefully read, Health and Safety and Use and Care guides. Keep these instructions close at hand for future reference.

YOUR SAFETY AND SAFETY OF OTHERS IS VERY IMPORTANT.

This manual and the dryer itself provide important safety warnings, to be read and observed at all times.



This is the safety alert symbol. This symbol alerts you to potential hazards that can kill or hurt you and others. All safety messages will follow the safety alert symbol or the word **DANGER** or **WARNING**. These words mean:

DANGER

Indicates a hazardous situation which, if not avoided, will cause serious injury.

WARNING

Indicates a hazardous situation which, if not avoided, could cause serious injury.

All safety warnings give specific details of the potential risk presented and indicate how to reduce risk of injury, damage and electric shock resulting from improper use of the dryer. Carefully observe the following instructions. Failure to observe these instructions may lead to risks. The Manufacturer declines any liability for injury to persons or animals or damage to property if these advices and precautions are not respected.

Very young (0-3 years) and young children (3-8 years) shall be kept away unless continuously supervised. Children from 8 years old and above and persons with reduced physical, sensory or mental capabilities or lack of experience and knowledge can use this dryer only if they are supervised or have been given instructions on safe appliance use and if they understand the hazards involved. Children shall not play with the dryer. Cleaning and user maintenance shall not be made by children without supervision.

Items that have been soiled with substances such as cooking oil, acetone, alcohol, petrol, kerosene, spot removers, turpentine, waxes

and wax removers should be washed in hot water with an extra amount of detergent before being dried in the tumble dryer.

Items such as foam rubber (latex foam), shower caps, waterproof textiles, rubber backed articles and clothes or pillows fitted with foam rubber pads should not be dried in the tumble dryer.

Remove all objects from pockets such as lighters and matches.

Do not use the tumble dryer if chemicals have been used for cleaning.

Oil-soaked items ignite spontaneously, especially when exposed to heat sources such as in a tumble dryer. The items become warm, causing an oxidation reaction in the oil. Oxidation creates heat. If the heat cannot escape, the item can become hot enough to catch fire. Piling, stacking or storing oil-soaked items can prevent heat from escaping and so create a fire hazard.

WARNING

Never stop a tumble dryer before the end of the drying cycle unless all items are quickly removed and spread out so that the heat is dissipated.

The last phase of the drying cycle is done without heat (cool down phase), to assure that the laundry stays at a temperature level which is not leading to a damaging of the laundry.

If you want to stack the dryer on a washing machine, first contact our After-Sales Service to verify if this is possible. Stacking of a dryer is only admitted if the dryer is safely fixed on the washing machine by using an appropriate stacking kit.

INTENDED USE OF THE PRODUCT

This dryer is designed solely for domestic usage. To aim the dryer as professional use is forbidden. The manufacturer declines all responsibility for inappropriate use or incorrect setting of the controls.

CAUTION: The dryer is not intended to be operated by means of an external timer or separate remote control system.

Do not use the dryer outdoors. Do not store explosive or flammable substances such as aerosol cans and do not place or use gasoline or other flammable materials in or near the dryer: a fire may break out if the dryer is inadvertently switched on.

INSTALLATION

Installation and repairs must be carried out by a qualified technician, in compliance with

the manufacturer's instructions and local safety regulations. Do not repair or replace any part of the dryer unless specifically stated in the user manual. Children should not perform installation operations. Keep children away during installation of the dryer. Keep the packaging materials (plastic bags, polystyrene parts, etc.) out of reach of children, during and after the installation of the dryer.

Use protective gloves to perform all unpacking and installation operations. After unpacking the dryer, make sure that it has not been damaged during transport. In the event of problems, contact the dealer or your nearest After-sales Service. The dryer must be handled and installed by two or more persons. Keep children away during installation of the dryer.

The dryer must be disconnected from the power supply before carrying out any installation operation. During installation, make sure the dryer does not damage the power cable. Only activate the dryer when the installation procedure has been completed.

After installation of the device to wait a few hours before starting it, to acclimatize to the environmental conditions of the room.

Do not install your dryer where it may be exposed to extreme conditions, such as: poor ventilation, high temperature

or below 5°C or above 35°C.

The dryer must not be installed behind a lockable door, a sliding door or a door with a hinge on the opposite side to that of the tumble dryer, in such a way that a full opening of the tumble dryer door is restricted.

The dryer must be placed with the back towards a wall, to avoid injuries by touching the rear panel, which can become hot during the drying process.

Do not install the dryer in rooms with poor ventilation. If you want to install it in a small storage room, toilet, bathroom or similar, assure a good ventilation (open door, ventilation grid or slot larger than 500 cm²).

When installing the dryer make sure that the four feet are stable and resting on the floor, adjusting them as required, and check that the dryer is perfectly level using a spirit level.

If possible use a hose to drain the water directly into the domestic plumbing system. This will avoid having to empty the water container at the end of each drying cycle, since the condensation water can be directly drained away.

Take care not to install the dryer on a deep-pile carpet.

If, due to lack of space, the dryer must be installed directly next to a gas or coal stove, a heat insulating plate (85 x 57 cm)

must be installed in between and the side of the plate facing the stove must be covered with aluminium foil.

The dryer is not designed for built-in installation.

The dryer can be installed under a worktop, provided that adequate ventilation of the dryer is assured. Install a ventilation grid (minimum 45 cm x 8 cm), in the rear part of the worktop under which the dryer is installed.

ELECTRICAL WARNINGS

Make sure the voltage specified on the rating plate corresponds to that of your home.

For installation to comply with current safety regulations, an omnipolar switch with minimum contact gap of 3mm is required.

Regulation require that the dryer is earthed.

For dryers with fitted plug, if the plug is not suitable for you socket outlet, contact a qualified technician.

Do not use extension leads, multiple sockets or adapters. Do not connect the dryer to a socket which can be operated by remote control.

The power cable must be long enough for connecting the dryer, once fitted in its housing, to the main power supply.

Do not pull the power supply cable.

If the power cable is damaged it must be replaced with an identical one. The power

cable must only be replaced by a qualified technician in compliance with the manufacturer instruction and current safety regulations. Contact an authorized service centre.

Do not operate this dryer if it has a damaged mains cord or plug, if it is not working properly, or if it has been damaged or dropped. Do not immerse the mains cord or plug in water. Keep the cord away from hot surfaces

The electrical components must not be accessible to the user after installation.

Do not touch the dryer with any wet part of the body and do not operate it when barefoot.

ELECTRICAL CONNECTION FOR GREAT BRITAIN AND IRELAND ONLY

Fuse replacement.

If the mains lead of this dryer is fitted with a BS 1363A 13amp fused plug, to change a fuse in this type of plug use an A.S.T.A. approved fuse to BS 1362 type and proceed as follows:

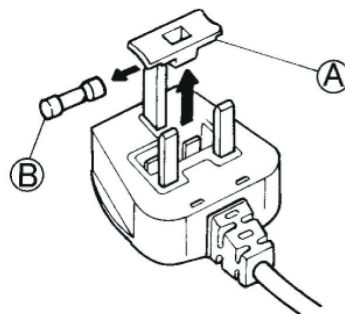

1. Remove the fuse cover (A) and fuse(B).
2. Fit replacement 13A fuse into fuse cover.
3. Refit both into plug.

Important:

The fuse cover must be refitted when changing a fuse and if the fuse cover is lost the plug must not be used until a correct replacement is fitted. Correct replacement are identified by the colour insert or the colour embossed in words on the base of the plug. Replacement fuse covers are available from your local electrical store.

For the Republic of Ireland only

The information given in respect of Great Britain will frequently apply, but a third type of plug and socket is also used, the 2-pin, side earth type.

Socket outlet / plug (valid for both countries)

If the fitted plug is not suitable for your socket outlet, please contact After-sales Service for further instruction. Please do not attempt to change plug yourself. This procedure needs to be carried out by a qualified technician in compliance with the manufactures instructions and current standard safety regulations.

CORRECT USE

Do not exceed the maximum load allowed. Check the maximum load allowed in the programme chart.

Do not dry unwashed items in the tumble dryer.

Do not overdry the laundry.

Take care that no lint or dust is accumulated around the dryer.

Fabric softeners, or similar products, should be used as specified by the fabric softener instructions.

CLEANING AND MAINTENANCE

The dryer must be disconnected from the power supply before carrying out any cleaning or maintenance operation.

Never use steam cleaning equipment.

SAFEGUARDING THE ENVIRONMENT

For dryer models with heat-pump technology:
This dryer contains fluorinated greenhouse gas (R134a). The circuit containing this gas is hermetically sealed. The electrical switchgear has a tested leakage rate of less than 0,1% per year.

DISPOSAL OF PACKAGING MATERIALS

The packaging material is 100% recyclable and is marked with the recycle symbol:



The various parts of the packaging must therefore be disposed of responsibly and in full compliance with local authority regulations governing waste disposal.

SCRAPPING OF HOUSEHOLD APPLIANCES

When scrapping the dryer, make it unusable by cutting off the power cable and removing the doors and shelves (if present) so that children cannot easily climb inside and become trapped.

This dryer is manufactured with recyclable



or reusable materials. Dispose of it in accordance with local waste disposal regulations.

For further information on the treatment, recovery and recycling of household electrical appliances, contact your competent local authority, the collection service for household waste or the store where you purchase the dryer.

This dryer is marked in compliance with European Directive 2012/19/EU, Waste Electrical and Electronic Equipment (WEEE). By ensuring this product is disposed of correctly, you will help prevent potential negative consequences for the environment and human health, which could otherwise be caused by inappropriate waste handling of this product. This symbol



on the product or on the accompanying documentation indicates that it should not be treated as domestic waste but must be taken to an appropriate collection centre for the recycling of electrical and electronic equipment.

ENERGY SAVING TIPS

Always dry a full load, depending on the type of laundry and the programme/drying time. For more detailed information, see the programme chart.

By preference use the maximum spin speed allowed by your washing machine, since

draining the water mechanically requires less energy. You will save time and energy when running your drying cycle.

Always select the correct programme/drying time for the load in order to obtain the desired drying results.

Select the 'Gentle' option only in case of drying small loads.

When drying cotton, for example, dry Iron Dry and Cupboard Dry loads together. Start with the Iron Dry programme/drying time setting, remove the laundry to be ironed at the end of that cycle and dry the remainder of the load on the Cupboard Dry setting.

DECLARATION OF CONFORMITY

This dryer has been designed, constructed and distributed in compliance with the safety requirements of European Directives:

- 2006/95/EC Low Voltage Directive
- 2004/108/EC Electromagnetic Compatibility Directive.

PRODUCT DESCRIPTION

APPLIANCE

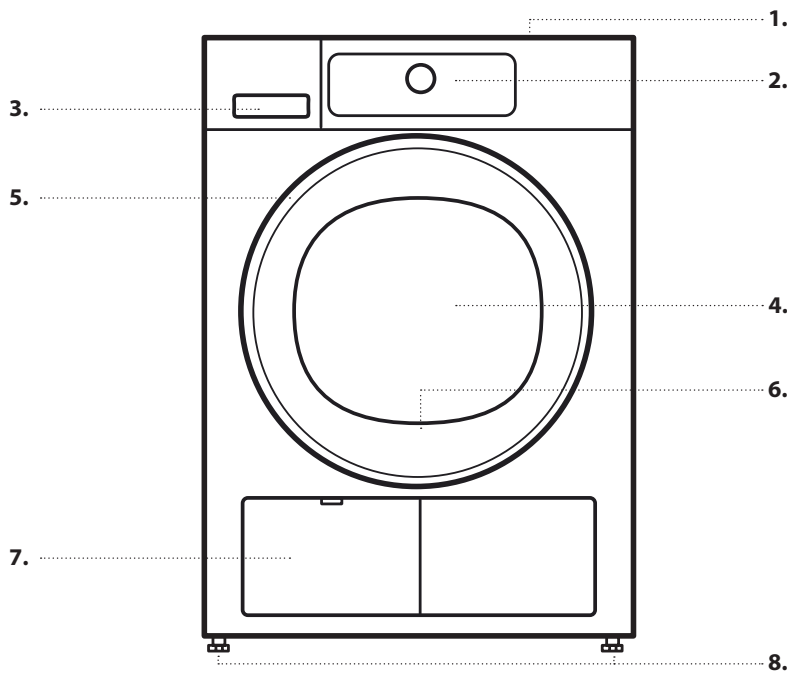

1. Worktop
2. Control panel
3. Water tank
4. Door
5. Door handle
6. Door filter (behind door)
7. Bottom filter (behind flap)
8. Adjustable feet (4)

CONTROL PANEL

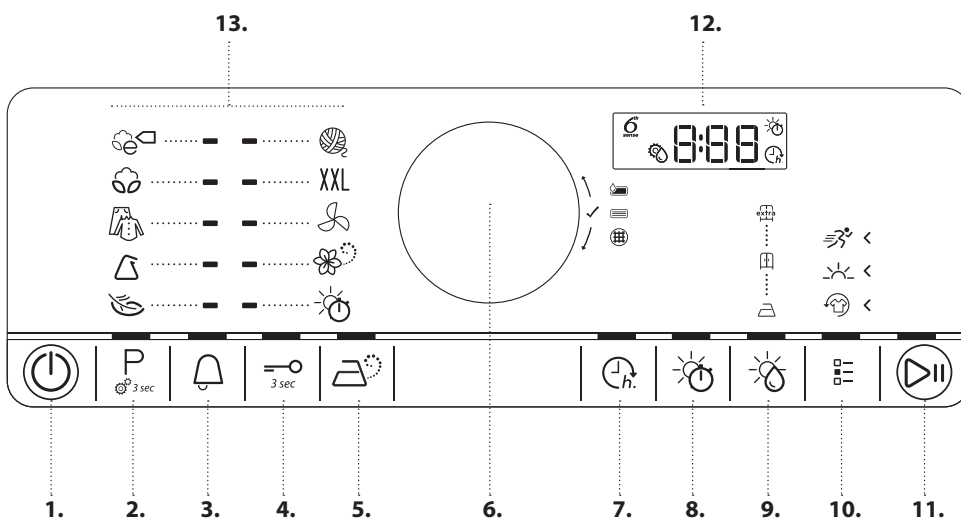

1. On/Off button (Reset if long pressed)
2. Programme button (Settings button if long pressed)
3. Cycle end alert
4. Key lock button
5. Steam refresh button
6. Knob (Turn to select / Press to confirm)
7. Start delay button
8. Drying / Airing time button
9. Drying level button
10. Options button
11. Start/Pause button
12. Display
13. Programmes area

DOOR

To open the door, pull the handle.

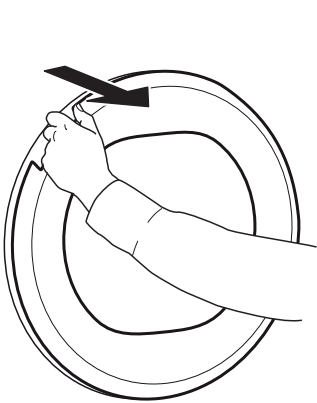

To close the door, hold the handle and push so that you can hear it click shut.

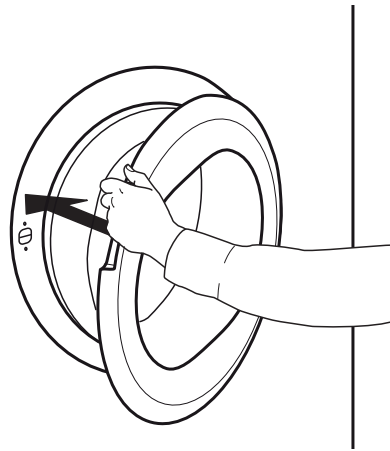

If you interrupt a running programme by opening the door, the programme will be reset if the dryer door is not closed again within one minute.

DRUM LIGHT (if available)

- During programme selection: the light goes on for laundry loading
- After programme start: the light fades on and off while the laundry load is detected.
- After programme end, when you open the door, the light goes on for a while for unloading the laundry. Then it goes off to save energy; touch any button to switch it on again.

AVAILABLE ACCESSORIES

Contact our After-Sales Service to check if the following accessory is available for your washing machine and dryer combination.

STACKING KIT SHELF

by which your dryer can be fixed on top of your washing machine to save space and to facilitate loading and unloading your dryer in the higher position.

HOW TO USE THE APPLIANCE

FIRST TIME USE

1. CHECK WATER TANK

Make sure that the water tank is correctly inserted

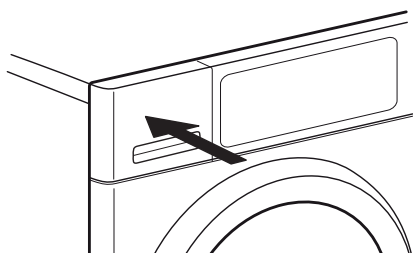

2 . CHECK DRAIN HOSE

Make sure that the drain hose on the back of the dryer is fixed, either to the dryer's water tank or to your domestic sewage system (see INSTALLATION GUIDE).

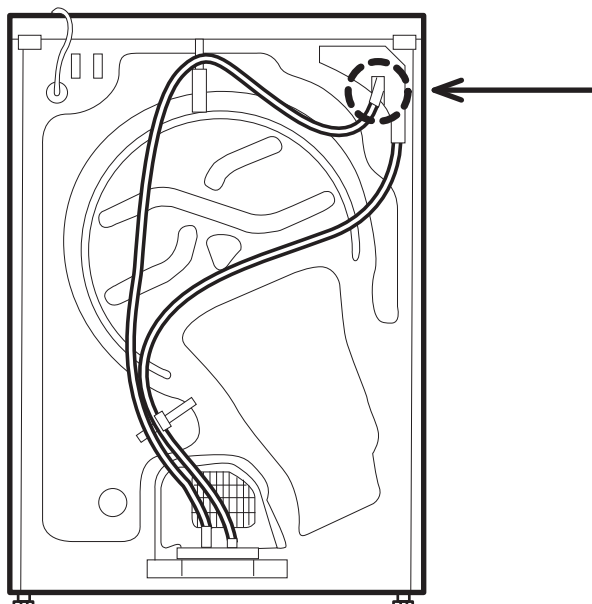

DAILY USE

⚠ WARNING

Make sure that no lighters or matches are left in clothing.



Make sure that the laundry is not soaked with flammable liquids.

1. LOAD THE LAUNDRY

Respect your items' care labels; make sure that the items to be dried are suitable for tumble drying.

Drying Care Labels

The dots indicate the temperature degree for drying the laundry.

-  Normal temperature
-  Reduced temperature
-  Do not tumble dry

Open the door and load the laundry. Observe the maximum load sizes given in the section Programmes.



2. CLOSE THE DOOR

Make sure that no items get stuck between the door glass and door filter.



Close the door so that you can hear it click shut.

⏻ 3. SWITCH ON DRYER

Press the *On/Off button* « until the programme button lights up. An animation appears on the display, followed by a beep. Afterwards the dryer is ready to be operated.

4. SET THE DESIRED PROGRAMME

GUIDED MODE – the button light will guide

you through setting your programme in the following order: selection of programme / drying time (ONLY if *Drying time* or *Airing programme* is selected) / dryness level (only if selectable / adjustable) / options. As soon as you confirm a selection by pressing the knob, the button light will jump to the next step.

P

Select programme:

Make sure that the *Programme button* « lights up.

Turn the knob to select the desired programme. The indicator next to the selected programme lights up.

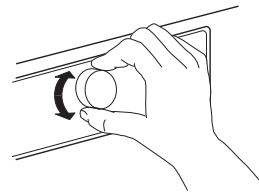

Confirm the desired programme by pressing the knob.

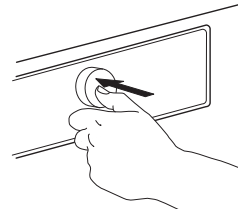

Find more information regarding programmes in section **PROGRAMMES, OPTIONS AND INDICATORS**.



Select Drying time, if needed

Only if you have selected programme *Drying time* or *Airing* «, you can set the desired drying time from a minimum of 10 minutes to maximum 180 minutes (three hours).

Make sure that the *Drying time button* lights up.

Turn the knob to select the desired drying / airing time. Confirm it by pressing the knob.



Set dryness level, if needed

If you want to change the dryness level, make sure that the *Dryness level button* « lights up.

Turn the knob to select the desired dryness level, afterwards press the knob to confirm.



Select options, if needed

If you want to select additional options, make sure that the *Options button* « lights up. The options which are selectable for your programme are indicated by a lighting arrow.

Turn the knob to select the desired options. The symbol of the selected option blinks. To confirm it, press the knob.

Some options / functions can be selected by directly pressing the button.



Refer to section **OPTIONS, FUNCTIONS AND INDICATORS** for more information.

CUSTOM MODE

After you have switched on the dryer, you are not forced to follow the **GUIDED MODE**. It is up to you which order you choose to set your programme. To choose a setting, first press the relevant button, then turn the knob to select, and finally press the knob to confirm.

The variety of options and dryness levels depends on the programme selected. Therefore it is recommended to start set-up by programme selection.



5. START PROGRAMME

Press and hold *Start/Pause* « until the button lights up solidly; the programme starts.

The duration can be recalculated and adapted in the course of the programme. During such phases, an animation appears on the display.

6. CHANGE THE SETTINGS OF A RUNNING PROGRAMME, IF NEEDED

You can still change some settings after a programme has started:

- Adjust drying time (only if programme *Drying time* or *Airing* is selected)
- Adjust or cancel *Start delay*, if a delay option is already in progress.
- Add or cancel an option, provided the progress of the programme still allows it.

Press the relevant button. The selected setting blinks for a few seconds. While blinking, you can adjust the setting by turning the knob. If the value or setting stopped blinking, press the button again.

Press the knob to confirm the modification. If you do not confirm, the modification is confirmed automatically — the modified setting stops blinking. The programme continues automatically.

To change the settings of a running programme or delay, you can also:

- press *Start/Pause* to put the running programme on hold
- change your settings
- press *Start/Pause* again to continue the programme.



7. CANCEL A RUNNING PROGRAMME, IF NEEDED

Press and hold the *On/Off button* « until "rES" appears on the display.

⚠ WARNING

After cancelling a running programme, quickly remove all items and spread them out so that the heat is dissipated.



8. SWITCH OFF THE DRYER AFTER PROGRAMME END

At the end of the programme, "End" appears on the display. Press *On/Off button* « to switch off the dryer. Open the door and take out your laundry.

The dryer switches off automatically in about a quarter of an hour after programme end, to save energy.

If not switched off right after programme end, the dryer will tumble the laundry for about 10 minutes, to prevent creasing. The display shows an animation.

9. EMPTY WATER TANK / CLEAN DOOR FILTER / CLEAN BOTTOM FILTER

Empty

- the water tank after each programme
- the door filter after each programme
- the bottom filter after every fifth programme.

Refer to section **CARE AND MAINTENANCE**







PROGRAMMES













The dots indicate the temperature degree for drying the laundry.



 Normal temperature

 Reduced temperature

 Do not tumble dry

PROGRAMME	Type of Wash and Recommendations	Care Labels	Regulations
ECO COTTON 	Standard cotton programme, suitable to dry normally wet cotton laundry. Most efficient programme in terms of energy consumption for drying cotton laundry. The values on the Energy Label are based on this programme.		MAX. LOAD (KG): max DEFAULT PROGRAMME DURATION (H): 1:40 SELECTABLE OPTIONS: Fresh care
COTTON 	For drying cotton laundry.		MAX. LOAD (KG): max DEFAULT PROGRAMME DURATION (H): 1:50 SELECTABLE OPTIONS: Steam option, Dryness level, Fresh care, Gentle, Rapid
MIXED 	For drying mixed laundry made of cotton, linen, artificial fibres and their blends.		MAX. LOAD (KG): 3.0 DEFAULT PROGRAMME DURATION (H): 1:20 SELECTABLE OPTIONS: Steam option, Fresh Care, Gentle

PROGRAMME	<i>Type of Wash and Recommendations</i>	<i>Care Labels</i>	<i>Regulations</i>
SYNTHETICS 	For drying laundry made of synthetic fibres.		MAX. LOAD (KG): 3.5 DEFAULT PROGRAMME DURATION (H): 0:55 SELECTABLE OPTIONS: Steam option, Dryness level, Fresh care, Gentle
DELICATES 	For drying delicate laundry which needs gentle treatment.		MAX. LOAD (KG): 2.5 DEFAULT PROGRAMME DURATION (H): 0:50 SELECTABLE OPTIONS: Fresh care
WOOL FINISH 	For finishing the air-drying process of woollen textiles. Woollens get fluffy and smooth.		MAX. LOAD (KG): 1.0 DEFAULT PROGRAMME DURATION (H): 0:05 SELECTABLE OPTIONS: ---
BIG ITEMS XXL	For drying big laundry items, such as bathmats, blankets etc.		MAX. LOAD (KG): 3.0 DEFAULT PROGRAMME DURATION (H): 1:20 SELECTABLE OPTIONS: Fresh care
AIRING 	For airing, refreshing and loosening up laundry for 30 minutes, without heating.	 	MAX. LOAD (KG): max DEFAULT PROGRAMME DURATION (H): 0:15 SELECTABLE OPTIONS: Drying time, Fresh care
STEAM REFRESH 	For refreshing laundry with steam. Specifically designed to refresh and remove odours from dry and clean casual garments like shirts, blouses, trousers made out of cotton, synthetics and their blends. Before loading the laundry into the drum, slightly humidify it by spraying it with water (maximum 200 ml; use a water spray bottle). Load the slightly humidified laundry into the drum and start the programme. After programme end, the garments shall be removed immediately and put on clothes hangers to minimise wrinkling.		MAX. LOAD (KG): 1.5 DEFAULT PROGRAMME DURATION (H): 0:30 SELECTABLE OPTIONS: ---

PROGRAMME	<i>Type of Wash and Recommendations</i>	<i>Care Labels</i>	<i>Regulations</i>
DRYING TIME 	<p>Time-restricted drying programme. Select programme duration by option Drying time.</p> <p>For all fabrics appropriate for tumble drying. Suitable to add an additional short drying phase after programme end.</p> <p>Refer to OPTIONS, FUNCTIONS AND INDICATORS / option Drying time for more information.</p>		<p>MAX. LOAD (KG): max</p> <p>DEFAULT PROGRAMME DURATION (H): 0:10</p> <p>SELECTABLE OPTIONS: Drying time, Fresh care</p>

max = maximum capacity of the dryer

Programme durations indicated in the table are default values. The programme duration mainly depends on the humidity level of the laundry and the volume of the laundry load. For that reason, the real programme duration can deviate from the indicated values.

OPTIONS

OPTIONS WHICH ARE DIRECTLY SELECTABLE BY PRESSING THE RESPECTIVE BUTTON

STEAM OPTION



Minimises creasing of garments made of cotton, synthetics and their blends by adding a humidifying phase at the end of the drying cycle.

Use the option with small loads only, unload the garments from the dryer

immediately after programme end and put them on clothes hangers.

The humidity level automatically adjusts to "cupboard dry" and cannot be changed with this option.

DRYING TIME OPTION



To adjust the desired drying time if Drying time or Airing programme has been selected.

Press the button; the light goes on, and the drying time which was used

last appears on the display.

Turn the knob to select the desired drying time from a minimum of 10 minutes up to maximum 180 minutes, afterwards press the knob to confirm.

DRYNESS LEVEL



To select the desired dryness level for the laundry load.

Press the button; the light goes on. Turn the knob to select the desired dryness level.

Choose between:

Iron Dry (suitable to be ironed after the drying cycle, therefore still slightly humid)

Cupboard Dry (dry enough to be put in a cupboard at the end of the drying cycle)

Extra Dry (maximum dryness level) and confirm by pressing the knob.

The dryness level is adjustable in programmes Cotton and Synthetics.

OPTIONS SELECTABLE WITH THE OPTIONS BUTTON



FRESH CARE



Helps to prevent creasing if you cannot unload the laundry soon after programme end.

The dryer starts to tumble the laundry periodically a few minutes after programme end. This tumbling will

last up to approximately 12 hours after end of the programme.

You can stop it at any time by switching off the dryer with the On/Off button.

GENTLE



Enables a more gentle treatment of the laundry by reducing the drying temperature.

RAPID



Enables quicker drying by shortening the programme duration.

FUNCTIONS

ON/OFF



To switch the dryer on: press the button until the Start/Pause button lights up.

To switch the dryer off after programme end: press the button until the lights go off.

To cancel a running programme: press and hold the button until "rES" appears on the display.

⚠ WARNING

After cancelling a running programme, quickly remove all items and spread them out so that the heat is dissipated.

KNOB

To select and confirm programmes, options and settings.

Turn to select

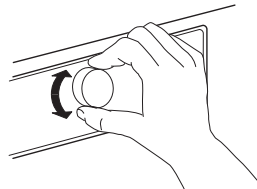

Push to confirm

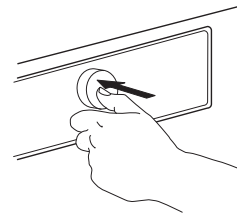

START/PAUSE



To start the programme, after you have finished your settings

To pause a running programme

To continue a paused programme

KEY LOCK



3 sec

This function allows you to lock the buttons and the knob of the control panel against unwanted operation, for example by small children.

The dryer must be switched on.



Press and hold the Key lock button until button lights up.



3 sec

Knob and buttons are locked now. The only working function is On/Off to switch the dryer off.

The key lock remains active also if you switch off and on again the dryer.

To unlock the buttons/knob, press and hold the option button again until the button light goes off.

START DELAY



Enables to have the laundry ready at a particular time by moving the start of the programme to a later time.

Select programme and options. Press the *Start delay* button – the button lights up.



Turn the knob to select a delay up to 23 hours. and confirm by pressing the knob.

Press *Start / Pause* - the display shows the countdown of the delay until start of the programme. The Start / Pause button lights up. A sound by activation of the pump may occur.



The colon on the display between hours and minutes blinks.

The programme starts automatically at the end of the delay period. On programme start, the delay on the display is replaced by the remaining programme duration.

When selecting a delay, the original programme duration appears again after the maximum possible delay of 23 hours. To exit the settings mode again without setting a delay, select

the default programme duration. To cancel a delay which has already been started:

Either press *Start/Pause* to cancel the delay. To start the selected programme immediately, press *Start/Pause* again.

Or press and hold *On/Off* to cancel the complete programme setting.

WATER CONDUCTIVITY SETTING



The drying results are affected by the conductivity of the water used during washing. If, by modifying the available dryness levels (iron dry; cupboard dry; extra dry), you are not satisfied with the final drying results, you can adapt the water conductivity level.

The dryer comes with preset level 2. Choose between
level 1 (most damp results)
and level 5 (most dry results).

Press and hold the Programme button until the Conductivity Adjustment symbol on the display blinks.



Turn the knob to adjust the level (1 – 2 – 3 – 4 – 5). Press the knob to confirm the selected level.

This operation is not needed for every drying cycle. Once the most satisfying water conductivity level has been identified, you no longer need to modify it.

INDICATORS

WATER TANK FULL

=> empty water tank

BOTTOM FILTER CLOGGED

=> clean bottom filter

DOOR FILTER CLOGGED

=> clean door filter

FAILURE**F..**

For any failure indication on the display, refer to section TROUBLESHOOTING for more information.

Find more information in section CARE AND MAINTENANCE, and TROUBLESHOOTING GUIDE.

ENERGY SAVING

AUTOMATIC SWITCH-OFF FUNCTION

The dryer is designed to save energy. After the programme has finished, it therefore switches off automatically after about a quarter of an hour.

ENERGY SAVING TIPS

- To reduce the drying time, make sure that the laundry is spun with the maximum possible spin speed of the wash programme. This reduces the moisture content in the laundry.
 - Preferably dry a full load, as indicated in the Programmes table. This optimises the relative energy consumption.
 - Do not over dry the laundry.
 - Clean the door filter after every drying cycle.
 - Clean the bottom filter after every fifth drying cycle.
-

- The optimum ambience temperature for the dryer is between 15 and 20 °C. In case of a higher temperature, air the room.
- Use *Gentle option* only with small loads.
- When drying cotton or synthetics laundry, run *Iron dry* and *Cupboard dry* loads together. Start the programme with dryness level *Iron dry*. At the end of the programme, remove the laundry to be ironed. Finish the drying process for the remaining load with dryness level *Cupboard dry*.

CLEANING & MAINTENANCE

⚠ WARNING

Do not use flammable fluids to clean the dryer.

For any cleaning and maintenance, switch off the dryer.

EMPTYING THE WATER TANK

Empty the water tank after each programme, provided the drain hose is not connected to your sewage system (refer to INSTALLATION GUIDE).

1. Hold the handle and carefully pull out the water tank. Hold the full water tank with both hands.

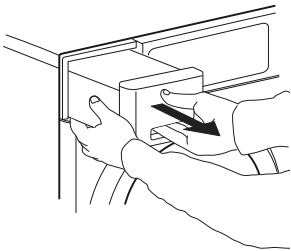

2. Empty the water.

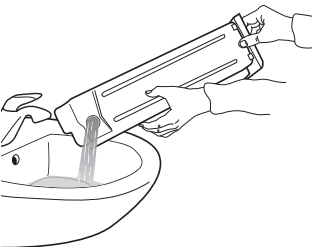

3. Insert the water tank by pushing it back into place. Make sure that it is completely inserted in the compartment.

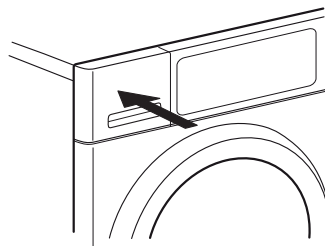

CLEANING THE DOOR FILTER

Clean the door filter after each programme. Make sure that the laundry is unloaded. Open the door.

- 1.** Remove the door filter by pulling it upwards.

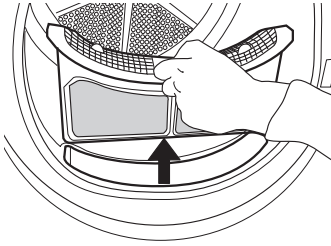

- 2.** Press the button to open the door filter.

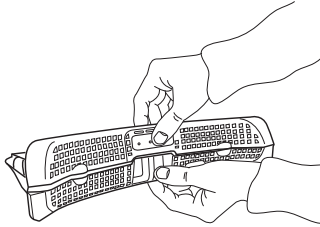

- 3.** Carefully remove the complete lint from the screen by hand. If needed, the screen can be cleaned also under running water, using a soft brush.

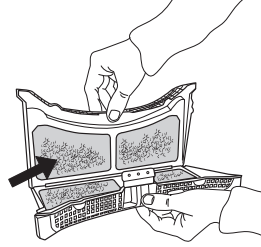

- 4.** Clean the filter compartment with a soft cloth, or carefully with a vacuum cleaner.

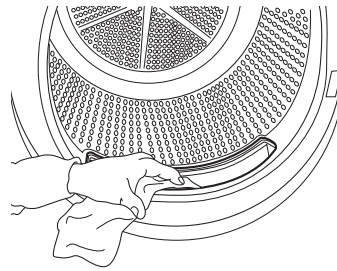

- 5.** Close the filter and reinsert it in the right direction, so that it completely integrates in the filter compartment.

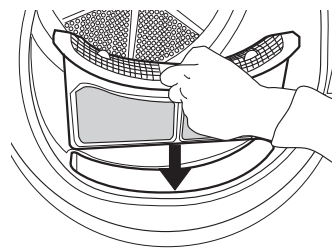

CLEANING THE BOTTOM FILTER

Clean the bottom filter about every three months.

- 1.** Carefully press down the strap to open the bottom flap.

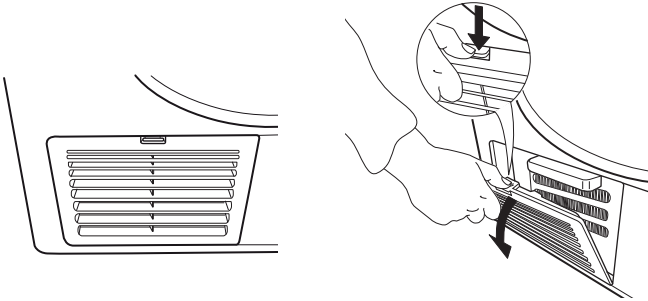

- 2.** Turn the locking bars right and left on the bottom filter downwards in horizontal position.

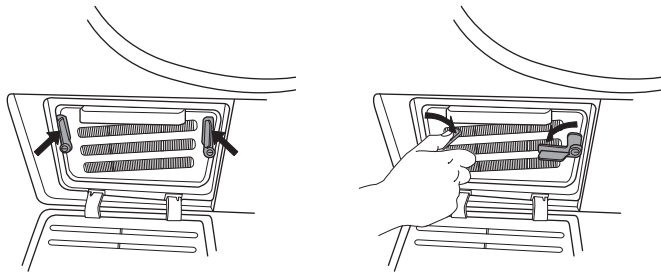

- 3.** Hold the bottom filter on the handle and pull it out.

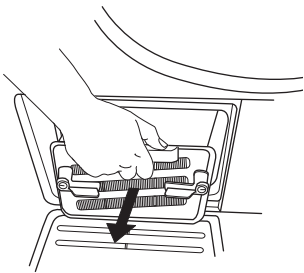

- 4.** Clean the bottom filter under running water; wipe away dust and lint.

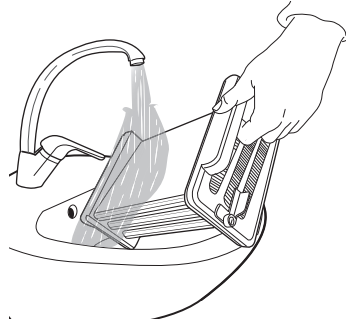

- 5.** Wipe the bottom filter dry, so that it is not dripping wet anymore.

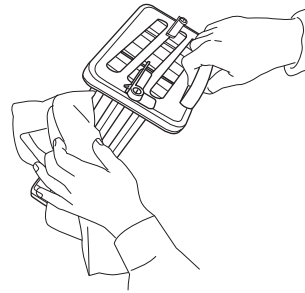

- 6.** Clean the filter compartment with a soft cloth or carefully with a vacuum cleaner.

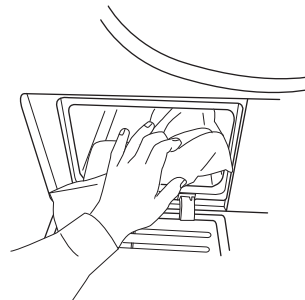

7. Push the bottom filter back into the filter compartment; make sure that it is completely integrated. Turn both locking bars (right and left) back into vertical position, to lock the bottom filter.

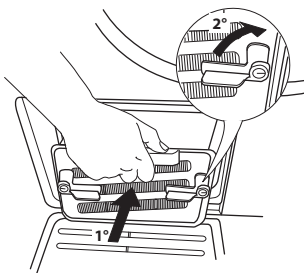

8. Finally close the bottom flap again.

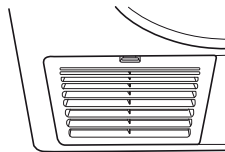

CLEANING THE OUTSIDE OF THE DRYER

Use a soft damp cloth to clean the outer parts of the dryer.

Do not use glass or general purpose cleaners, scouring powder or similar to clean the control panel – these substances might damage the surfaces.



REVERSING THE DOOR STOP

If needed, the door stop of the dryer door can be reversed. Use pliers and a cross-head screwdriver for the procedure.

For removing and fixing the door, the help of a second person is recommended. Make sure that the dryer is unplugged. Open the dryer door.

- 1.** Remove the two screws which are situated over and under the door lock, left from the door opening.

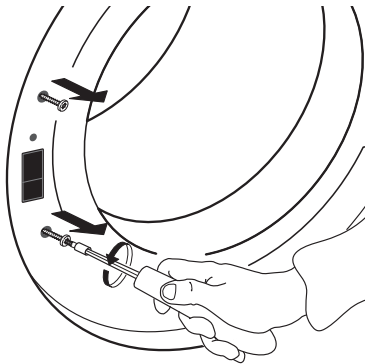

- 2.** Press the small knob above the door lock with a small screwdriver. At the same time move upwards the door lock and pull it towards you with your finger.

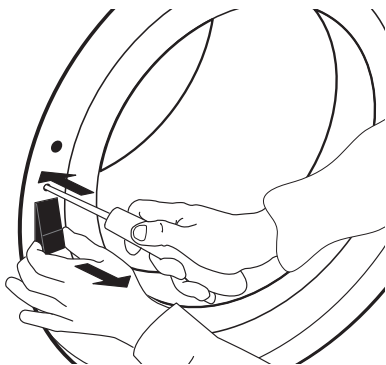

- 3.** Remove the two screws on the door hinge.

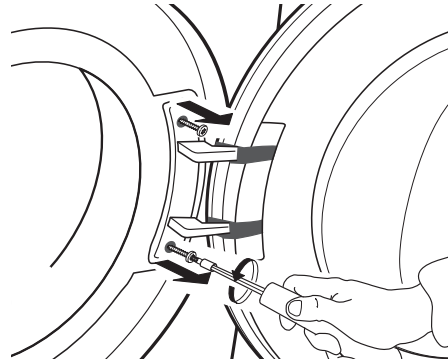

- 4.** Remove the door and carefully lay it upside down on a blanket or similar.

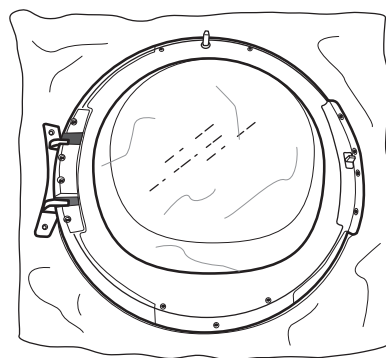
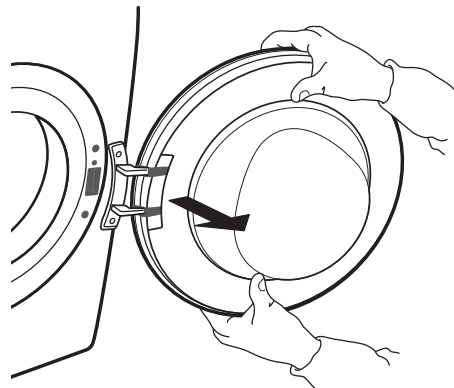

- 5.** Unscrew the bottom screw, to release the cover frame on the front of the door.

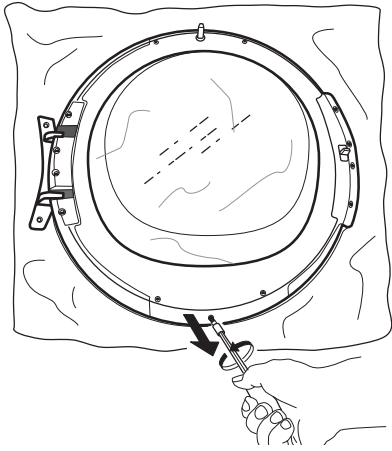

- 6.** Turn the door and lay it down on the door glass.

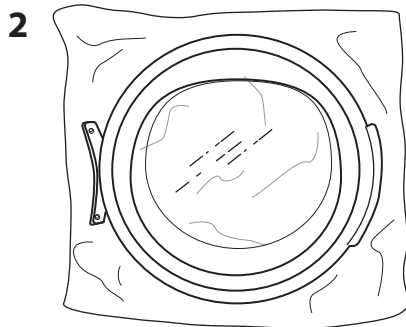
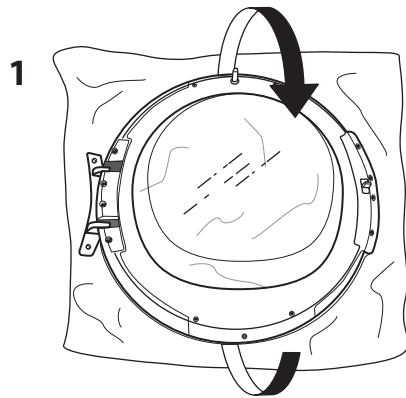

- 7.** Carefully turn the door frame in clockwise direction, and remove it.

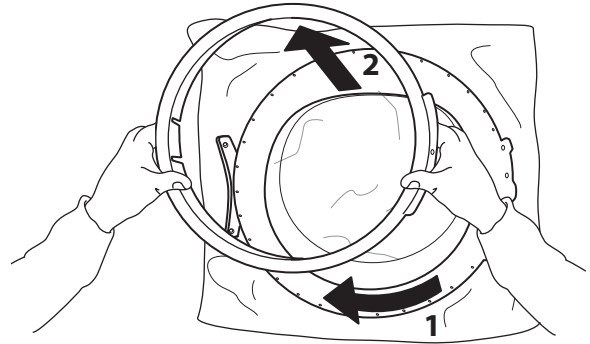

- 8.** Turn the door again and lay it upside down.

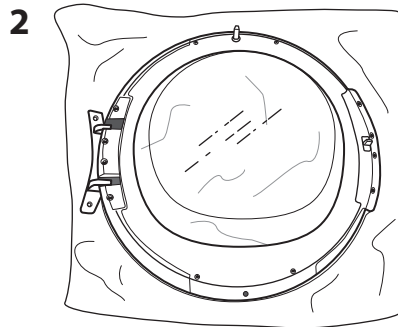
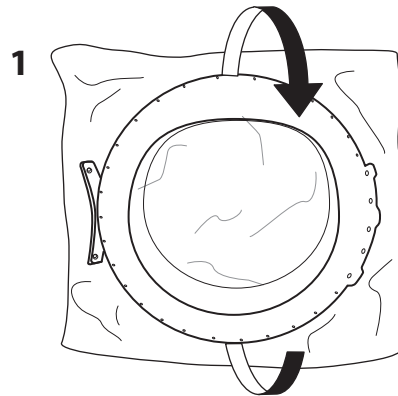

9. Remove the two side screws. Do this on both sides of the door.

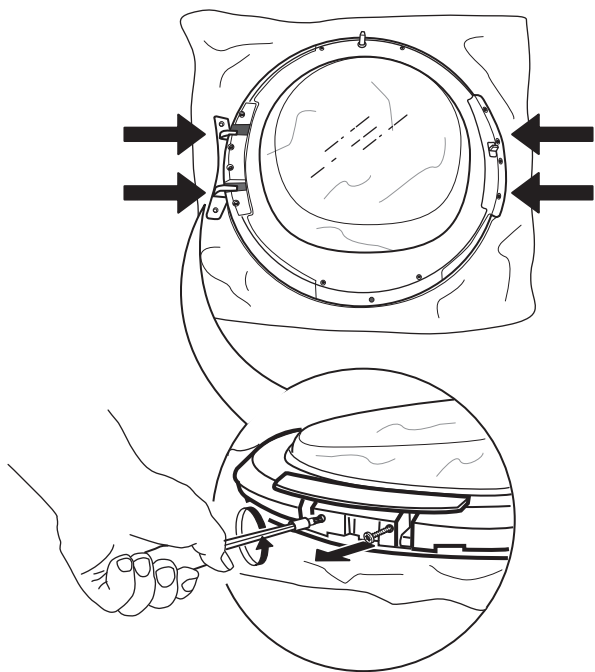

10. Remove the 4 inner screws on each side of the door.

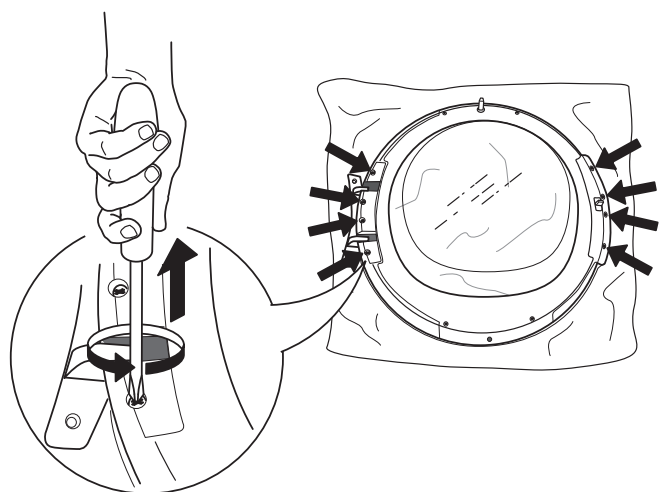

11. Remove the side parts on each side of the door.

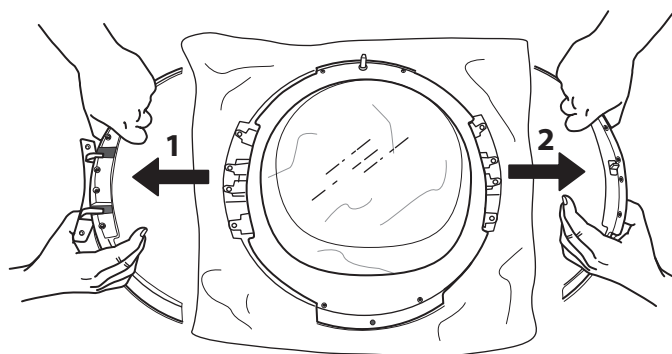

12. Reverse the side parts and insert them again.

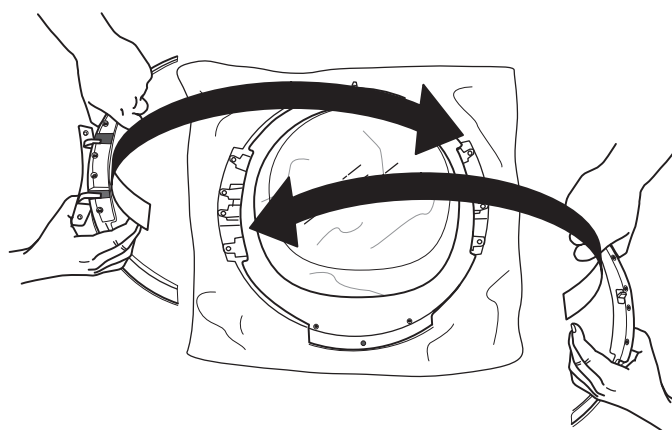

13. Fix the 2 side screws on both sides of the door again.

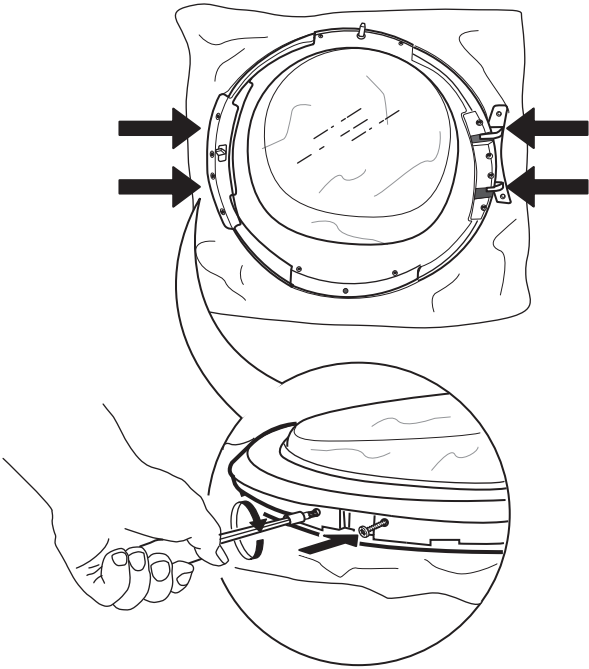

14. Fix the 4 inner screws on each side again.

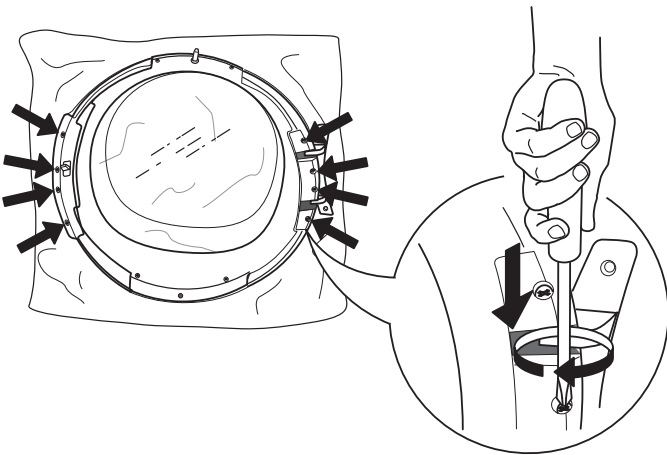

15. Turn the door and lay it down on the door glass.

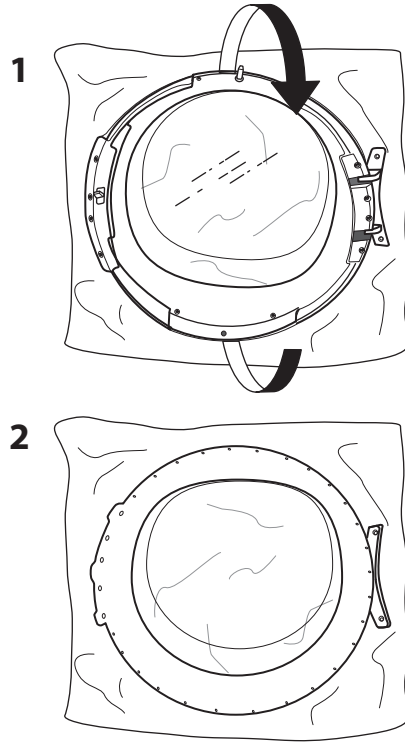

16. Refit the door frame.

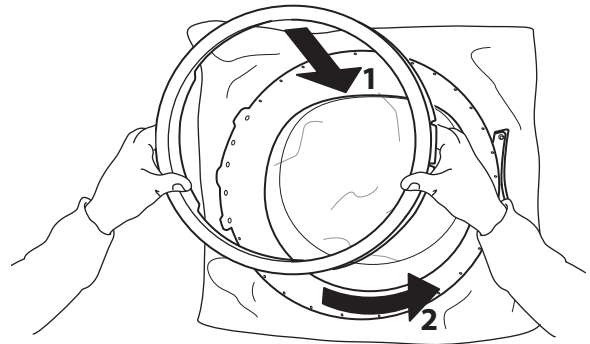

17. Turn the door again and lay it upside down. Fix the bottom screw again.

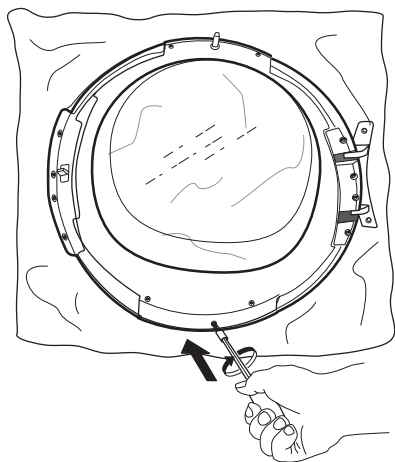

19. Fix the two screws over and under the door lock, on the right side of the door opening.

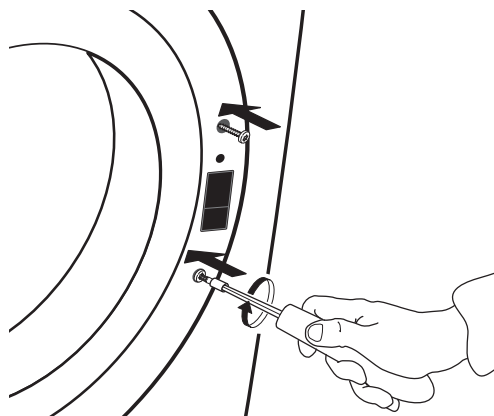

18. Insert the door lock on the right side of the door opening. Press it completely inside the hole and move it a bit downwards, until the small knob of the door lock latches.

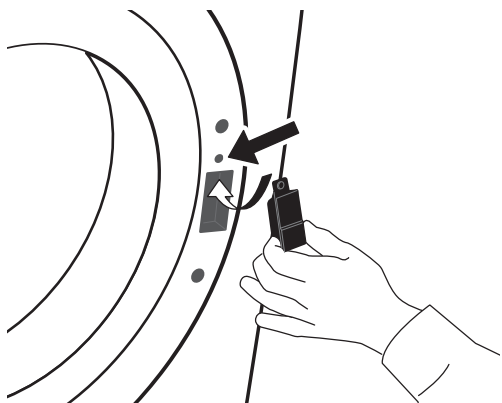

20. Fix the door on the left side of the door opening by turning in the two screws.

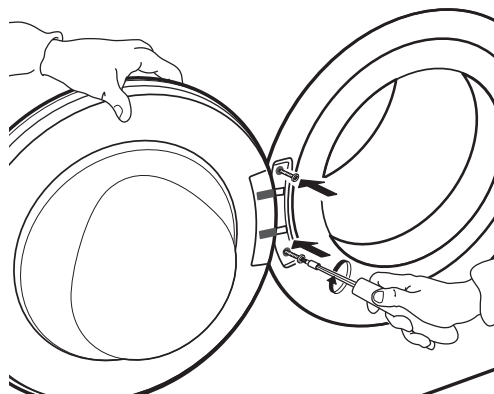

TROUBLESHOOTING GUIDE & AFTER-SALES SERVICE

Your dryer is equipped with various automatic safety functions. These enable failures to be detected in good time and the safety system can react appropriately. These failures are frequently so minor that they can be removed within a few minutes.

<i>Problem</i>	<i>Possible Cause</i>	<i>Solution</i>
DRYING TAKES TOO LONG LAUNDRY IS NOT DRY ENOUGH	Selected programme not optimum for type of laundry	<ul style="list-style-type: none"> • Select the programme matching best the type of laundry; refer to section PROGRAMMES
	Door filter or bottom filter clogged	<ul style="list-style-type: none"> • Clean the filters according to the instructions in section CARE AND MAINTENANCE
	Laundry too wet	<ul style="list-style-type: none"> • Make sure that laundry is spun with the maximum spin speed before drying. If laundry was spun with spin speed below 800 rpm, the water tank may get full during the drying programme.
	The ambient temperature is too high	<ul style="list-style-type: none"> • The ambient temperature is ideal between 15 and 20°C. If the ambient temperature is higher, air the room.
DRYER DOES NOT START, ALTHOUGH START/PAUSE HAS BEEN PRESSED	Door not properly closed	<ul style="list-style-type: none"> • Push door to close it until it clicks shut
	Key lock is activated	<ul style="list-style-type: none"> • Press and hold the button with the key symbol until the display indicates that the keys are unlocked.

**WATER DROPLETS ARE
BENEATH THE DRYER**

Bottom filter not inserted
correctly

- Check position of the bottom filter and make sure it is completely integrated in the filter compartment.

Lint remaining on bottom filter or
door seal

- Remove lint residues on the rubber seals of bottom filter and door seal.

Water tank not inserted correctly

- Push in the water tank and make sure that it is completely integrated in the tank compartment.

Direct drain connection not
working properly

- Check drain connection and make sure that the water can drain.



Dryer not standing level

- Check level position of dryer on the tabletop with a water level; if needed adjust the dryer feet.
(refer to INSTALLATION GUIDE).

FAILURE INDICATOR AND MESSAGES

Make sure to

- Empty the water tank after each programme
- Clean the door filter after each programme
- Clean the bottom filter after every fifth programme

<i>Failure Indicator</i>	<i>Possible Cause</i>	<i>Solution</i>
	Water tank may be <ul style="list-style-type: none"> • filled with water • not correctly positioned 	<ul style="list-style-type: none"> • Empty water tank; make sure to insert it properly afterwards. • Push in the water tank to make sure that it is correctly inserted in the tank compartment.
	Bottom filter may be <ul style="list-style-type: none"> • blocked by lint • not correctly positioned 	<ul style="list-style-type: none"> • Clean the bottom filter; make sure to insert it properly afterwards • Push in the bottom filter and move the release levers into vertical position, to make sure that the filter is correctly inserted in the filter compartment. Close the flap.
	Door filter may be <ul style="list-style-type: none"> • blocked by lint • not correctly positioned 	<ul style="list-style-type: none"> • Remove and clean the door filter; make sure to insert it properly afterwards so that it completely integrates in the filter compartment. • Check position of the door filter; make sure that it is properly inserted in the filter compartment.

Refer to section CARE AND MAINTENANCE for emptying water tank or cleaning filters.

Below is a summary of possible failure causes and solutions.

If the problem persists after having followed the instructions as indicated below, press and hold On/Off for at least three seconds. If afterwards the failure indication still appears, switch off and unplug the dryer and contact our After-Sales Service.

<i>Display message</i>	<i>Possible Cause</i>	<i>Solution</i>
F01 to F04	Failure of a component	Press and hold On/Off for at least 3 seconds.
F05 to F09	Failure of a component	Switch off and unplug the dryer. Immediately open the door and take out the laundry, so that the heat can dissipate. Make sure that the ambient temperature ranges between 5°C and 35°C. Wait for about an hour. Plug in the dryer, load the laundry and start the programme again. If the failure persists, call the After-Sales Service.
F10 to F24	Failure of a component	Switch off and unplug the dryer. Wait for about half an hour. Plug in the dryer and start the programme again. If the failure persists, call the After-Sales Service.

TRANSPORT AND HANDLING

**WARNING**

Never lift the dryer by holding it at the worktop.

1. Unplug the dryer.

.....

2. Make sure that door and water tank are properly closed.

3. If the drain hose is connected to your sewage system, fix the drain hose on the rear of the dryer again (see Installation Guide).

AFTER-SALES SERVICE

BEFORE CALLING THE AFTER-SALES SERVICE

1. See if you can solve the problem by yourself with the help of the suggestions given in the **TROUBLESHOOTING GUIDE.**

.....

2. Switch the appliance off and on again to see if the failure persists.

IF AFTER THE ABOVE CHECKS THE FAILURE STILL OCCURS, GET IN TOUCH WITH THE NEAREST AFTER-SALES SERVICE

To receive assistance, call the number shown on the warranty booklet or follow the instructions on the website **www.whirlpool.eu**

Always specify:

- a brief description of the failure;
- the type and exact model of the appliance;
- the service number (number after the word Service on the rating plate on the back of the dryer).
The service number is also indicated on the guarantee booklet;
- your full address;
- your telephone number.

SERVICE 0000 000 00000



For any repairs, use our authorized After-Sales Service, to ensure proper repairing and use of original spare parts.

Manufacturer:
Whirlpool Europe s.r.l. Socio Unico
Viale Guido Borghi 27
21025 Comerio (VA)
Italy

1.

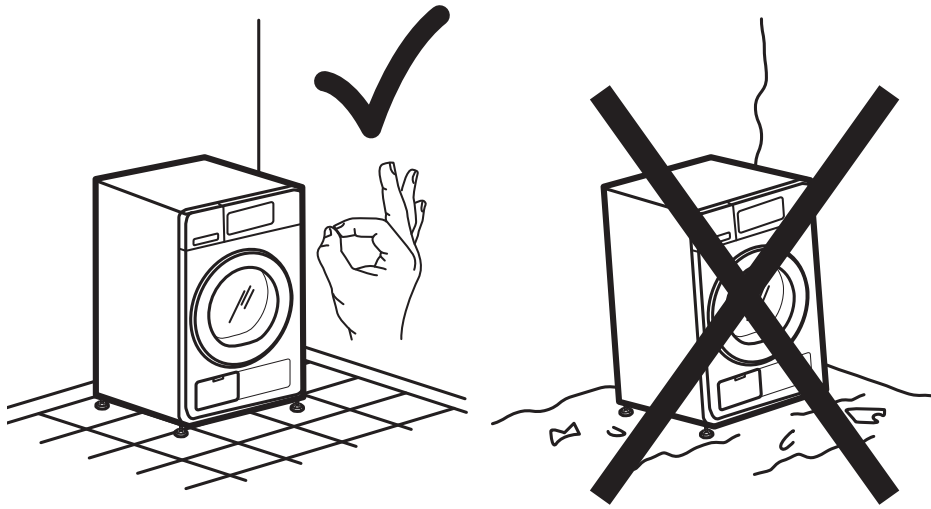

2a.

2b.

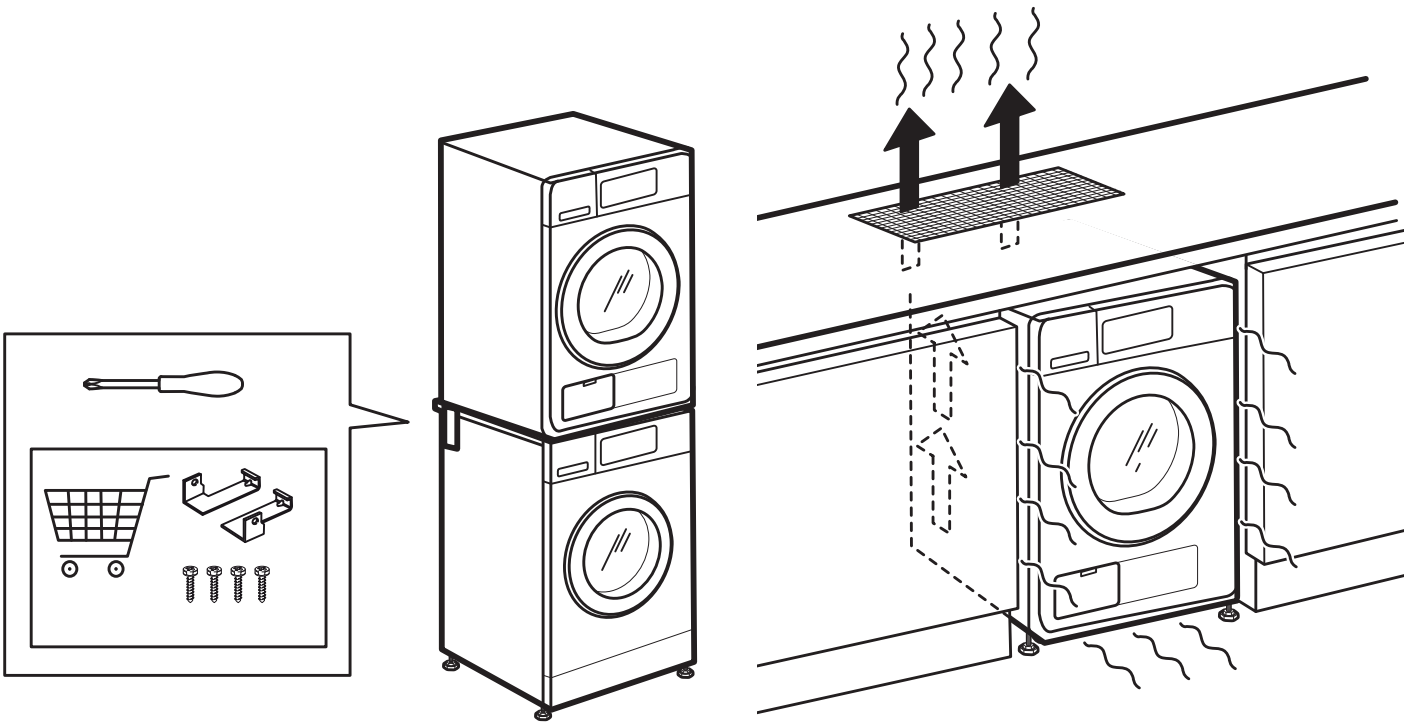

3a.

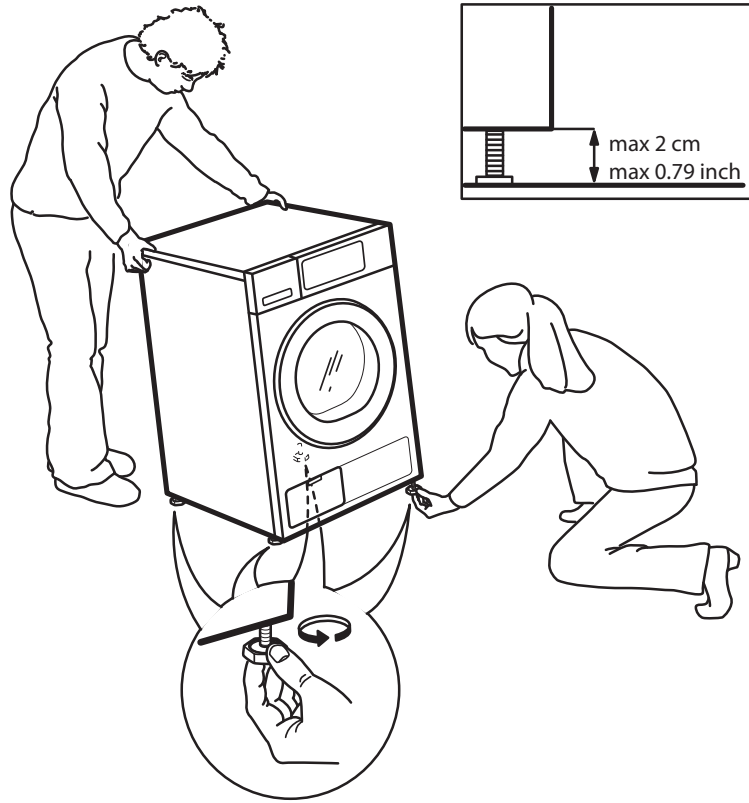

3b.

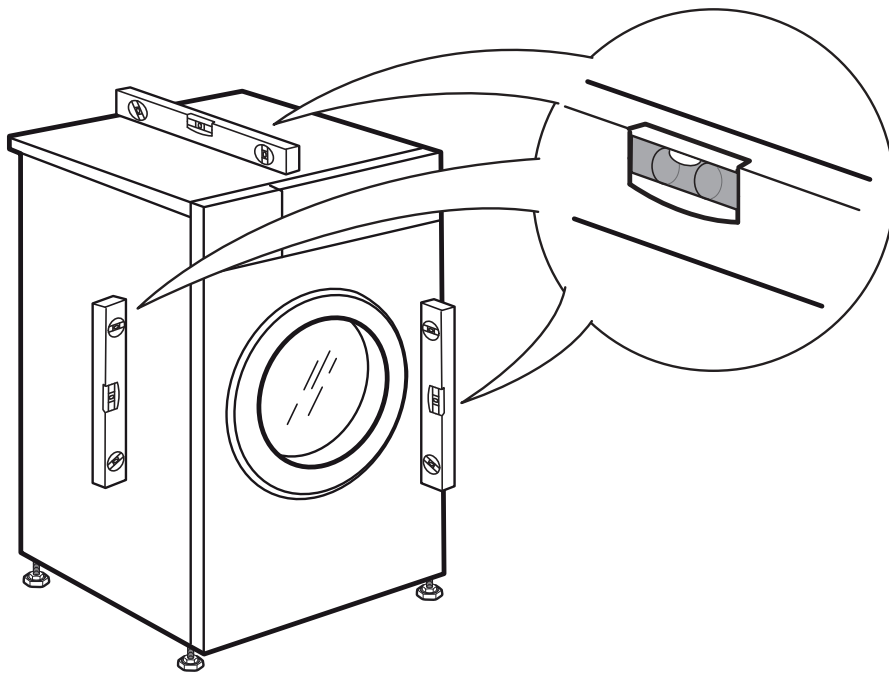

4.

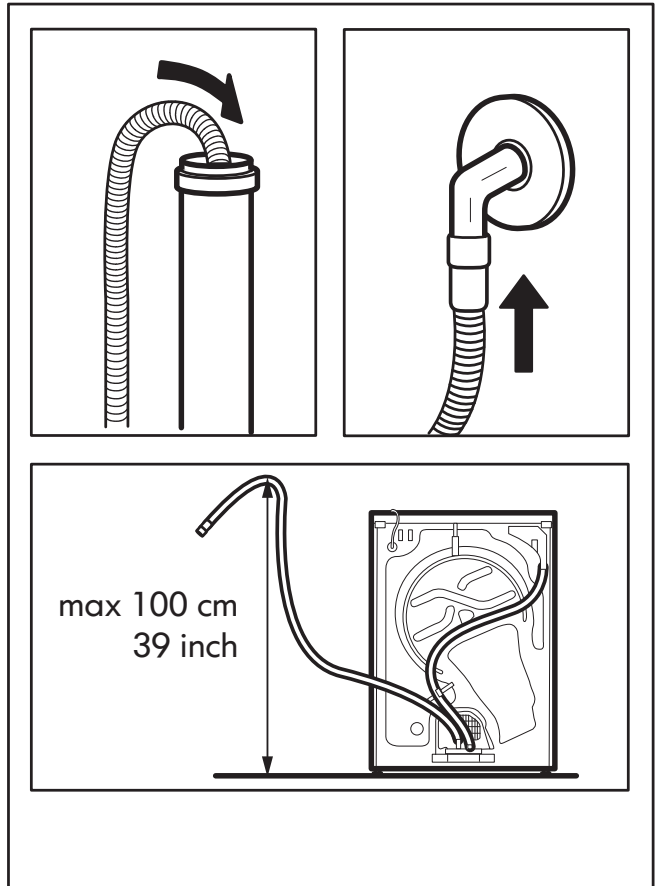
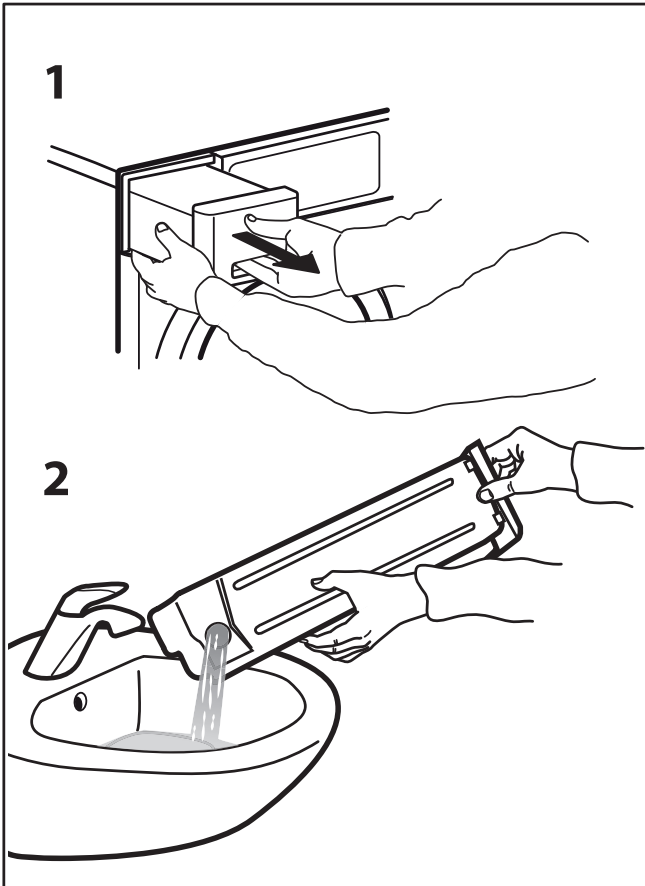
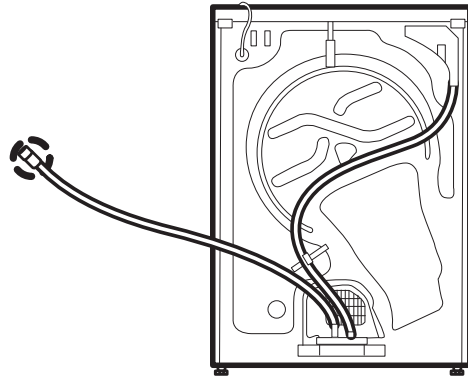
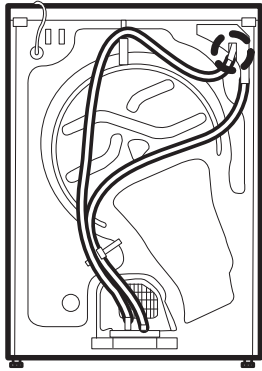

5.

6a.

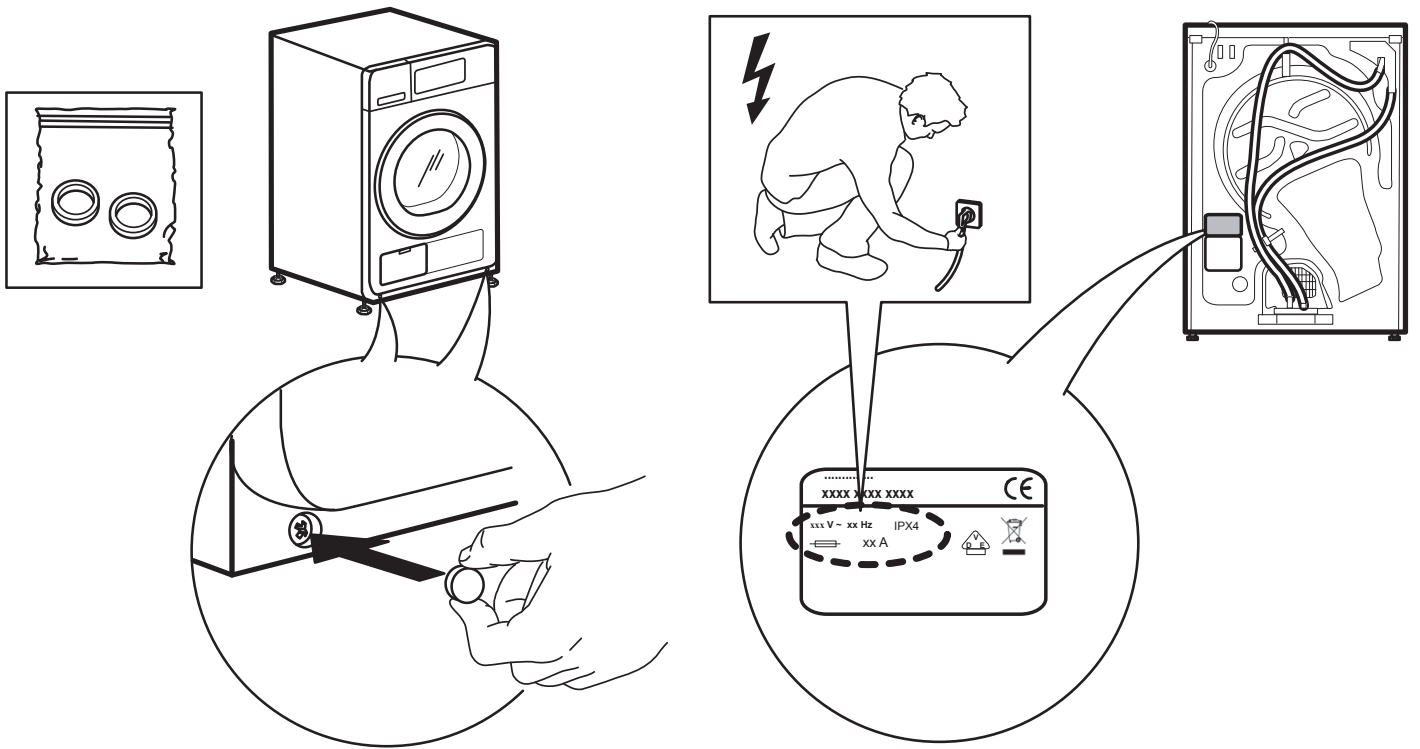

6b.

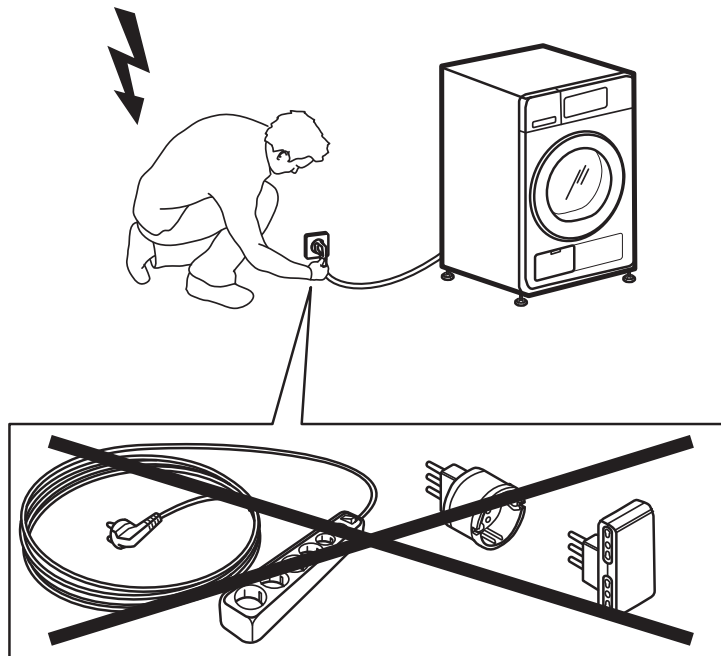

Whirlpool is a registered trademark of Whirlpool, USA



400010765173



SENSING THE DIFFERENCE