

EN ENGLISH

Safety Instructions	3
Daily Reference Guide	7
Installation Guide	17

EN

SAFETY INSTRUCTIONS

IMPORTANT TO BE READ AND OBSERVED

⚠ These instructions are valid if the country symbol appears on the appliance. If the symbol does not appear on the appliance, please refer to the technical instructions which will provide the necessary instructions concerning modification of the appliance to the conditions of use of the country.

⚠ CAUTION : Use of the gas cooking appliance results in the production of heat, moisture and products of combustion in the room in which it is installed. Ensure that the kitchen is well ventilated, especially when the appliance is in use: keep natural ventilation holes open or install a mechanical ventilation device (mechanical extractor hood). Prolonged intensive use of the appliance may call for additional ventilation, such as opening a window, or more effective ventilation, for example increasing the level of mechanical ventilation (if possible).

⚠ Failure to follow the information in this manual exactly may cause a fire or explosion, resulting in property damage or personal injury.

Before using the appliance, read these safety instructions. Keep them nearby for future reference.

These instructions and the appliance itself provide important safety warnings, to be observed at all times. The manufacturer declines any liability for failure to observe these safety instructions, for inappropriate use of the appliance or incorrect setting of controls.

⚠ WARNING : If the hob surface is cracked, do not use the appliance – risk of electric shock.

⚠ WARNING : Danger of fire : Do not store items on the cooking surfaces.

⚠ CAUTION : The cooking process has to be supervised. A short cooking process has to be supervised continuously.

⚠ WARNING: Leaving the hob unattended when cooking with fat or oil can be dangerous – risk of fire. NEVER try to extinguish a fire with water, but switch off the appliance and then cover the flames e.g. with a lid or a fire blanket.

⚠ Do not use the hob as a work surface or support. Keep clothes or other flammable materials away from the appliance, until all the components have cooled down completely – risk of fire.

⚠ Very young children (0-3 years) should be kept away from the appliance. Young children (3-8 years) should be kept away from the appliance unless continuously supervised. Children from 8 years old and above and persons with reduced physical, sensory or mental capabilities or lack of experience and knowledge can use this appliance only if they are supervised or have been given instructions on safe use and understand the

hazards involved. Children must not play with the appliance. Cleaning and user maintenance must not be carried out by children without supervision.

⚠ CAUTION : In case of hotplate glass breakage: shut immediately off all burners and any electrical heating element and isolate the appliance from the power supply; - do not touch the appliance surface; -do not use the appliance



The glass lid can break in if it is heated up. Turn off all the burners and the electric plates before closing the lid. Do not shut down lid when burner alight

⚠ WARNING: The appliance and its accessible parts become hot during use. Care should be taken to avoid touching heating elements. Children less than 8 years of age must be kept away unless continuously supervised

⚠ Never leave the appliance unattended during use. If the appliance is suitable for probe usage, only use a temperature probe recommended for this oven - risk of fire.

⚠ Keep clothes or other flammable materials away from the appliance, until all the components have cooled down completely - risk of fire. Always be vigilant when cooking foods rich in fat, oil or when adding alcoholic beverages - risk of fire. Use oven gloves to remove pans and accessories. At the end of cooking, open the door with caution, allowing hot air or steam to escape gradually before accessing the cavity - risk of burns. Do not obstruct hot air vents at the front of the oven - risk of fire.

⚠ Exercise caution when the oven door is in the open or down position, to avoid hitting the door. When you place the rack inside, make sure that the stop is directed upwards and in the back of the cavity.

The device shall not be operated for more 15 s. If after 15s the burner has not lit, stop operating the device and open the compartment door and/or wait at least 1 min before attempting a further ignition of the burner.

PERMITTED USE

⚠ CAUTION: The appliance is not intended to be operated by means of an external switching device, such as a timer, or separate remote controlled system.

⚠ This appliance is intended to be used in household and similar applications such as: staff kitchen areas in shops, offices and other working environments; farm houses; by clients in hotels, motels, bed & breakfast and other residential environments.

⚠ No other use is permitted (e.g. heating rooms).

⚠ This appliance is not for professional use. Do not use the appliance outdoors.

⚠ Do not store explosive or flammable substances (e.g. gasoline or aerosol cans) inside or near the appliance - risk of fire.

⚠ Use pots and pans with bottoms the same width as that of the burners or slightly larger (see specific table). Make sure pots on the grates do not protrude beyond the edge of the hob.

⚠ Improper use of the grids can result in damage to the hob: do not position the grids upside down or slide them across the hob.

Do not let the burner flame extend beyond the edge of the pan.

Do not use : Cast iron griddles, ollar stones, terracotta pots and pans. Heat diffusers such as metal mesh, or any other types. Two burners simultaneously for one receptacle (e.g. Fish kettle).

Should particular local conditions of the delivered gas make the ignition of burner difficult, it is advisable to repeat the operation with the knob turned to small flame setting.

In case of installation of a hood above the cooktop, please refer to the hood instructions for the correct distance.

The protective rubber feet on the grids represent a choking hazard for young children. After removing the grids, please ensure that all the feet are correctly fitted.

INSTALLATION

⚠ The appliance must be handled and installed by two or more persons - risk of injury. Use protective gloves to unpack and install - risk of cuts.

⚠ The electrical and gas connections must comply with local regulations.

⚠ Installation, including water supply (if any), electrical connections and repairs must be carried out by a qualified technician. Do not repair or replace any part of the appliance unless specifically stated in the user manual. Keep children away from the installation site. After unpacking the appliance, make sure that it has not been damaged during transport. In the event of problems, contact the dealer or your nearest Aftersales Service. Once installed, packaging waste (plastic, styrofoam parts etc.) must be stored out of reach of children - risk of suffocation. The appliance must be disconnected from the power supply before any installation operation - risk of electric shock. During installation, make sure the appliance does not damage the power cable - risk of fire or electric shock. Only activate the appliance when the installation has been completed.

⚠ **WARNING** : Modification of the appliance and its method of installation are essential in order to use the appliance safely and correctly in all the additional countries.

⚠ Use pressure regulators suitable for the gas pressure indicated in the instructions.

⚠ The room must be equipped with an air extraction system that expels any combustion fumes.

⚠ The room must also allow proper air circulation, as air is needed for combustion to occur normally. The flow of air must not be less than 2 m³/h per kW of installed power.

⚠ The air circulation system may take air directly from the outside by means of a pipe with an inner cross section of at least 100 cm²; the opening must not be susceptible to blockages.

⚠ The system can also provide the air needed for combustion indirectly, i.e. from adjacent rooms fitted with air circulation tubes as described above. However, these rooms must not be communal rooms, bedrooms or rooms that may present a fire hazard.

⚠ Liquid petroleum gas sinks to the floor as it is heavier than air. Therefore, rooms containing LPG cylinders must also be equipped with vents to allow gas to escape in the event of a leak. This means LPG cylinders, whether partially or completely full, must not be installed or stored in rooms or storage areas that are below ground level (cellars, etc.). It is advisable to keep only the cylinder being used in the room, positioned so that it is not subject to heat produced by external sources (ovens, fireplaces, stoves, etc.) which could raise the temperature of the cylinder above 50°C.

Should you find it difficult to turn the knobs for the burner, please contact the After-sales Service, who can replace of the burner tap if found to be faulty.

The openings use for the ventilation and dispersion of heat must never be covered.

⚠ Do not remove the appliance from its polystyrene foam base until the time of installation.

Connection with rigid pipe (copper or steel).

If the gas pressure is different from the recommended pressure, a suitable pressure regulator must be fitted to the inlet pipe in accordance with the current National Regulations.

⚠ Do not install the appliance behind a decorative door - risk of fire.



if the range is placed on a base, it must be leveled and fixed to the wall by the retention chain provided, to prevent the appliance slipping from the base.



WARNING: In order to prevent the appliance from tipping, the retention chain must be installed. Refer to the instructions for installation.

GAS CONNECTION

⚠ **WARNING** : Prior to installation, ensure that the local distribution conditions (type of gas and gas pressure) and the configuration of the appliance are compatible.

⚠ Check that the pressure of the gas supply is consistent with the values indicated in Table 1 ("Burner and nozzle specifications").

⚠ **WARNING** : The configuration conditions of this appliance are stated on the label (or data plate).

⚠ **WARNING** : This appliance is not connected to a combustion products evacuation device. It

must be installed and connected in accordance with current installation regulations. Particular attention must be paid to the relevant requirements regarding ventilation.

⚠ If the appliance is connected to liquid gas, the regulation screw must be fastened as tightly as possible.

⚠ **IMPORTANT** : When the gas cylinder or gas container is installed, it must be properly settled (vertical orientation).

⚠ **WARNING** : This operation must be performed by a qualified technician

⚠ Use only flexible or rigid metal hose for gas connection.

⚠ Connection with a rigid pipe (copper or steel)
Connection to the gas system must be carried out in such a way as not to place any strain of any kind on the appliance. There is an adjustable L-shaped pipe fitting on the appliance supply ramp and this is fitted with a seal in order to prevent leaks. The seal must always be replaced after rotating the pipe fitting (the seal is provided with the appliance). The gas supply pipe fitting is a threaded 1/2 gas cylindrical male attachment.

⚠ Connecting a flexible jointless stainless steel pipe to a threaded attachment

The gas supply pipe fitting is a threaded 1/2 gas cylindrical male attachment. These pipes must be installed so that they are never longer than 2000 mm when fully extended. Once connection has been made, make sure that the flexible metal pipe does not touch any moving parts and is not compressed. Only use pipes and seals that comply with current national regulations.

⚠ **IMPORTANT** : If a stainless steel hose is used, it must be installed so as not to touch any moving part of the furniture (e.g. drawer). It must pass through an area where there are no obstructions and where it is possible to inspect it across its entire length.

⚠ The appliance should be connected to the main gas supply or to a gas cylinder in compliance with the current national regulations. Before making the connection, make sure that the appliance is compatible with the gas supply you wish to use. If it is not, follow the instructions indicated in the paragraph "Adapting to different types of gas".

⚠ After connection to the gas supply, check for leaks in accordance with current National Regulations and Standards in force in the country of installation. Light up the burners and turn the knobs from max position 1* to minimum position 2* to check flame stability.

⚠ Connection to the gas network or the gas cylinder may be carried out using a flexible rubber or steel hose, in accordance with current national legislation.

ADAPTING TO DIFFERENT TYPES OF GAS

(This operation needs to be carried out by a

qualified technician.)

⚠ In order to adapt the appliance to a type of gas other than the type for which it was manufactured (indicated on the rating label), follow the dedicated steps provided after installation drawings.

ELECTRICAL WARNINGS

⚠ **IMPORTANT**: Information about current and voltage consumption is provided on the rating plate.

⚠ The rating plate is on the front edge of the oven (visible when the door is open).

⚠ It must be possible to disconnect the appliance from the power supply by unplugging it if plug is accessible, or by a multi-pole switch installed upstream of the socket in accordance with the wiring rules and the appliance must be earthed in conformity with national electrical safety standards.

⚠ The power cable must be long enough to connect the appliance, once fitted in its housing, to the main power supply. Do not pull the power supply cable.

⚠ Do not use extension leads, multiple sockets or adapters. The electrical components must not be accessible to the user after installation. Do not use the appliance when you are wet or barefoot. Do not operate this appliance if it has a damaged power cable or plug, if it is not working properly, or if it has been damaged or dropped.

⚠ If the supply cord is damaged, it must be replaced with an identical one by the manufacturer, its service agent or similarly qualified persons in order to avoid a hazard - risk of electric shock.

⚠ If the power cable needs to be replaced, contact an authorised service centre.

⚠ **WARNING**: Ensure that the appliance is switched off before replacing the lamp to avoid the possibility of electric shock.

CLEANING AND MAINTENANCE

⚠ **WARNING**: Ensure that the appliance is switched off and disconnected from the power supply before performing any maintenance operation; never use steam cleaning equipment - risk of electric shock.

⚠ Do not use harsh abrasive cleaners or metal scrapers to clean the door glass since they can scratch the surface, which may result in shattering of the glass.

⚠ Do not use abrasive or corrosive products, chlorine-based cleaners or pan scourers.

⚠ Make sure the appliance has cooled down before cleaning or performing maintenance. - risk of burns.

⚠ **WARNING**: Switch off the appliance before replacing the lamp - risk of electric shock.

⚠ To avoid damaging the electric ignition device, do not use it when the burners are not in their housing.

Wear protective gloves for cleaning and maintenance.

DISPOSAL OF PACKAGING MATERIALS

The packaging material is 100% recyclable and is marked with the recycle symbol . The various parts of the packaging must therefore be disposed of responsibly and in full compliance with local authority regulations governing waste disposal.

DISPOSAL OF HOUSEHOLD APPLIANCES

This appliance is manufactured with recyclable or reusable materials. Dispose of it in accordance with local waste disposal regulations. For further information on the treatment, recovery and recycling of household electrical appliances, contact your local authority, the collection service for household waste or the store where you purchased the appliance. This appliance is marked in compliance with European Directive 2012/19/EU, Waste Electrical and Electronic Equipment (WEEE). By ensuring this product is disposed of correctly, you will help prevent negative consequences for the environment and human health. The symbol  on the product or on the accompanying documentation indicates that it should not be treated as domestic waste but must be taken to an appropriate collection centre for the recycling of electrical and electronic equipment.

ENERGY SAVING TIPS

Only preheat the oven if specified in the cooking table or your recipe. Use dark lacquered or enamelled baking trays as they absorb heat better.

Use a pressure cooker to save even more energy and time.

DECLARATION OF CONFORMITY

This appliance meets Ecodesign requirements of European Regulation 66/2014 in compliance with the European standard EN 60350-1.

This appliance meets Ecodesign requirements of European Regulation 66/2014 in compliance with the European standard EN 60350-2.

This appliance meets Ecodesign requirements of European Regulation 66/2014 in compliance with the European standard EN 30-2-1

This appliance meets Ecodesign requirements of European Regulation 65/2014 in compliance with the European standard EN 15181.

NOTICE

! VERY HOT SURFACES

FOOD OR GREASE ON THESE SURFACES COULD CAUSE SMOKE AND POSSIBLY EVEN BURN

YOU MUST KEEP THE OVEN AND GRILL CAVITIES CLEAN

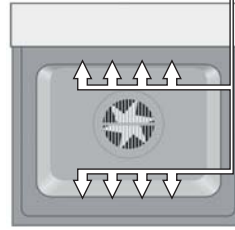

! ATTENTION

DURING INSTALLATION THE FEET OF THE APPLIANCE MUST BE LOWERED SO THAT AN AIR GAP OF AT LEAST 10MM (1CM) IS LEFT BETWEEN THE BASE OF THE APPLIANCE AND THE FLOOR.



! ATTENTION

WHEN USING THE MAIN OVEN YOU MUST ENSURE THAT THE BASE OF THE CAVITY IS NOT COVERED WITH ALUMINUM FOIL, UTENSIL OR ANY OTHER FORM OF COVERING. FAILURE TO DO THIS MAY RESULT IN THE CAVITY BEING DAMAGED.



DAILY REFERENCE GUIDE



Read the safety instructions carefully before using the product

PRODUCT DESCRIPTION

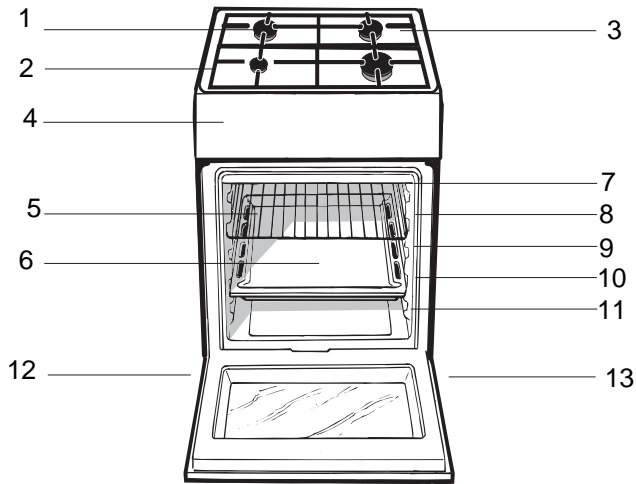

- 1. Gas burner
- 2. Hob grid
- 3. Containment surface for spills
- 4. Control panel
- 5. GRILL
- 6. DRIPPING PAN
- GUIDE RAILS for the sliding racks
- 7. position 5
- 8. position 4
- 9. position 3
- 10. position 2
- 11. position 1
- 12. Adjustable foot
- 13. Adjustable foot

CONTROL PANEL

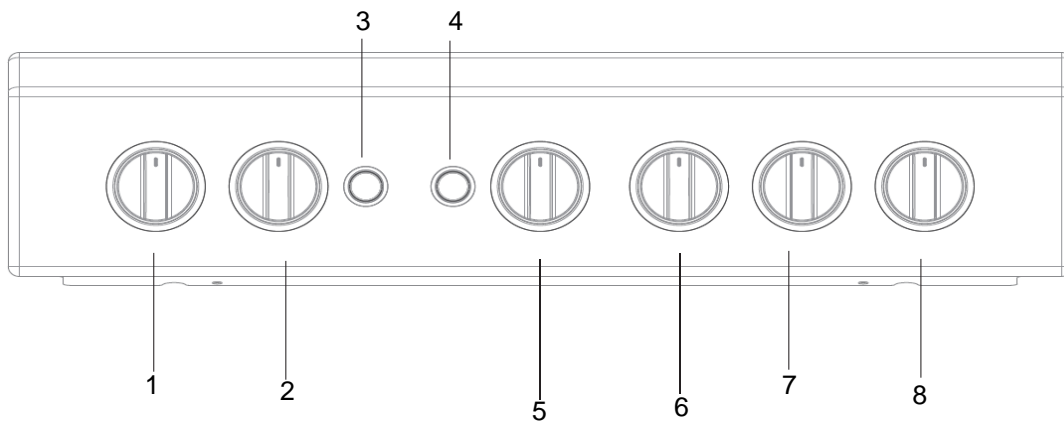

- 1. Control Knobs for Gas Burners on Hob
- 2. Control Knobs for Gas Burners on Hob

- 3. Button for Oven Light
- 4. Ignition button

- 5. Oven and Grill Control Knob
- 6. Timer Knob

- 7. Control Knobs for Gas Burners on Hob
- 8. Control Knobs for Gas Burners on Hob

INSTALLATION TIPS

Positioning

This unit may be installed and used only in permanently ventilated rooms according to the British Standards Codes Of Practice: B.S. 6172/B.S. 5440, Par. 2 and B.S. 6891 Current Editions. The following requirements must be observed:

- The cooker should not be installed in a bed sitting room with a volume of less than 20m³. If it is installed in a room of volume less than 5m³ an air vent of effective area of 100cm² is required, if it is installed in a room of volume between 5m³ and 10m³ a supplementary airvent area of 50cm² is required, if the volume exceeds 10m³ no airvent is required. However, if the room has a door or a window which opens directly to the outside no air vent is required even when the volume is between 5m³ and 10m³. The room containing the appliance must contain an openable window or an acceptable alternative such as an adjustable louvre or hinged panel opening direct to outside air.
- During prolonged use of the appliance you may consider it necessary to open a window to the outside to improve ventilation.
- If there are other fuel burning appliances in the same room, B.S.5440 Part 2 Current Edition, should be consulted to determine the requisite air vent. The height of the cooker can be adjusted by means of adjustable feet in the plinth (900mm - 915mm). Adjust the feet by tilting the cooker from the side. Then install the product into position.

The appliance must not be installed behind a decorative door in order to avoid overheating

This appliance must not be fitted on a platform.

The cooker is designed to fit between kitchen cabinets spaced 500mm apart. The space either side need only be sufficient to allow withdrawal of the cooker for servicing. It can be used with cabinets one side or both as well as in a corner setting. It can also be used free-standing.

Adjacent side walls which project above hob level, must not be nearer to the cooker than 150mm or 65mm and should be protected by heat resistant material. Any overhanging surface or cooker hood should not be nearer than 750mm.

- The cooker may be located in a kitchen, a kitchen/diner or bed sitting room, but not in a bathroom or shower room.
- The hoods must be installed according to the requirements in the hood handbook.
- The wall in contact with the back of the cooker must be of flameproof material.
- The cooker is fitted with a safety chain that must be attached to a hook, secured to the wall behind the appliance.

Gas connection

The cooker should be connected to the gas-supply by a gas safe registered installer. During installation of this product it is essential to fit an approved gas

tap to isolate the supply from the appliance for the convenience of any subsequent removal or servicing. Connection of the appliance to the gas mains or liquid gas must be carried out according to the prescribed regulation in force, and only after it is ascertained that it is adaptable to the type of gas to be used. If not, follow the instructions indicated in the paragraph headed "Adaptation to different gas types". On some models the gas supply can be connected on the left or on the right, as necessary; to change the connection, reverse the position of the hose holder with that of the cap and replace the gasket (supplied with the appliance). In the case of connection to liquid gas, by tank, use pressure regulators that conform to the regulation in force. The gas supply must be connected to the left of the appliance. Be sure that the hose does not pass through the rear of the cooker touching hot parts.

Make sure the supply pressure conforms with the values shown in the table entitled "Characteristics of the burners and nozzles".
When the cooker is installed between cabinets (recessed), the gas connection must be effected by an approved flexible hose with bayonet fitting (BS 669 Current Edition). The gas inlet for the cookers is a threaded G 1/2 gas female fitting.

Adapting to different types of gas

It is possible to adapt the appliance to a type of gas other than the default type (this is indicated on the rating label on the cover).

Adapting the hob

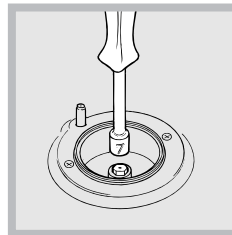

Replacing the nozzles for the hob burners:

- Remove the hob grids and slide the burners off their seats.
- Unscrew the nozzles using a 7 mm socket spanner (see figure), and replace them with nozzles

suited to the new type of gas(see Burner and nozzle specifications table).

- Replace all the components by following the above instructions in reverse.

Adjusting the hob burners' minimum setting:

- Turn the tap to the minimum position.
- Remove the knob and adjust the regulatory screw, which is positioned inside or next to the tap pin, until the flame is small but steady.

! If the appliance is connected to a liquid gas supply, the bypass screw must be set to a minimum.

- While the burner is alight, quickly change the position of the knob from minimum to maximum and vice versa several times, checking that the flame is not extinguished.

Upon completion of adjustment, reseal using sealing wax or an equivalent material.

! The hob burners do not require primary air adjustment.

⚠ WARNING : This operation must be performed by a qualified technician

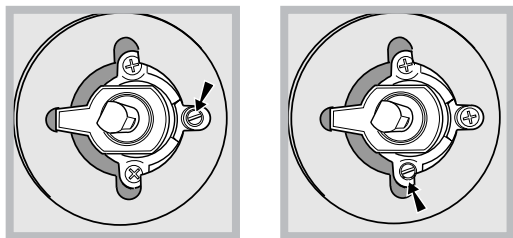

! After adjusting the appliance so it may be used with a different type of gas, replace the old rating label with a new one which corresponds to the new type of gas (these labels are available from Authorised Technical Assistance Centres).

! Should the gas pressure used be different (or vary slightly) from the recommended pressure, a suitable pressure regulator must be fitted to the inlet hose in accordance with current standards EN 88-1 and EN 88-2 relating to "regulators for channelled gas".

! The hob burners do not require primary air adjustment.

! After adjusting the appliance so it may be used with a different type of gas, replace the old rating label with a new one that corresponds to the new type of gas (these labels are available from Authorised Technical Assistance Centres).

! Should the gas pressure used be different (or vary slightly) from the recommended pressure, a suitable pressure regulator must be fitted to the inlet hose in accordance with current national regulations relating to "regulators for channelled gas".

Adapting the oven

Replacing the oven burner nozzle:

1. Remove the oven compartment.

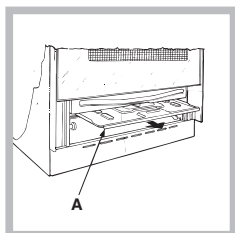

2. Slide out the protection panel A (see diagram).

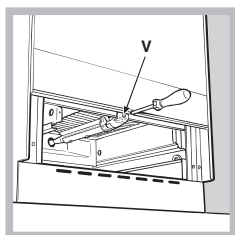

3. Remove the oven burner after unscrewing the screws V (see figure).

The whole operation will be made easier if the oven door is removed.

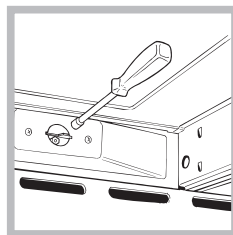

4. Unscrew the nozzle using a special nozzle socket spanner (see figure) or with a 7 mm socket spanner, and replace it with a new nozzle that is suited to the new type of gas (see *Burner and nozzle specifications table*).

Adjusting the gas oven burner's minimum setting:

1. Light the burner (see *Start-up and Use*).

2. Turn the knob to the minimum position (MIN) after it has been in the maximum position (MAX) for approximately 10 minutes.

3. Remove the knob.

4. Tighten or loosen the adjustment screws on the outside of the thermostat pin (see figure) until the flame is small but steady.

! If the appliance is connected to liquid gas, the bypass screw must be adjusted to minimum.

Upon completion of adjustment, reseal using sealing wax or an equivalent material.

5. Turn the knob from the MAX position to the MIN position quickly or open and shut the oven door, making sure that the burner is not extinguished.

Adapting the grill

Replacing the grill burner nozzle:

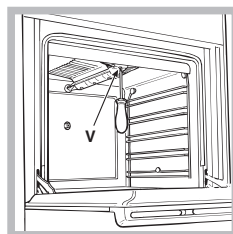

1. Remove the oven burner after loosening screw V (see figure).

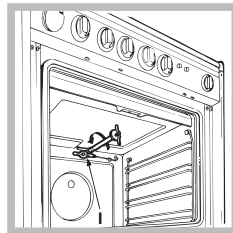

2. Unscrew the grill burner nozzle using a special nozzle socket spanner (see figure) or preferably with a 7 mm socket spanner, and replace it with a new nozzle that is suited to the new type of gas (see *Burner and nozzle specifications table*).

! Be careful of the spark plug wires and the thermocouple tubes.

! The oven and grill burners do not require primary air adjustment.

! After adjusting the appliance so it may be used with a different type of gas, replace the old rating label with a new one that corresponds to the new type of gas (these labels are available from Authorised Technical Assistance Centres).

! Should the gas pressure used be different (or vary slightly) from the recommended pressure, a suitable pressure regulator must be fitted to the inlet hose in accordance with current national regulations relating to "regulators for channelled gas".

EN TECHNICAL DATA

TECHNICAL DATA	
Burners	may be adapted for use with any type of gas shown on the data plate, which is located inside the flap or, after the oven compartment has been opened, on the left-hand wall inside the oven.

After installing the power cable, screw the metal cover with three screws.

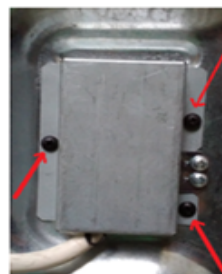

Mains frequency and voltage of the electric section and characteristics of the gas section

Model	Gas section	
	Class	Rated Power kW (1)
IS5G4PHX/UK	II2H3+	10,60 (771 g/h-G30) (757 g/h-G31)

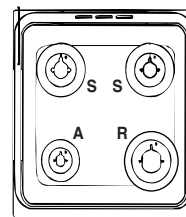

(1) The values in g/h refer to the capacities with liquid gas (Butane, Propane).

Table of burner and nozzle specifications

Burner	Diameter (mm)	Thermal Power kW (p.c.s.*)		Liquid Gas				Natural Gas	
				By-Pass 1/100 (mm)	Nozzle 1/100 (mm)	Flow* g/h		Nozzle 1/100 (mm)	Flow* l/h
						Nominal	Reduced		
Fast (Large)(R)	100	3.00	0.7	41	87	218	214	128	286
Semi Fast (Medium)(S)	75	1.90	0.4	30	69	138	136	104	181
Auxiliary (Small)(A)	51	1.00	0.4	30	50	73	71	78	95
Oven	-	2.80	1.0	46	80	204	200	119	267
Grill	-	2.30	-	-	75	167	164	114	219
Supply Pressures	Nominal (mbar)					28-30	37	20	
	Minimum (mbar)					20	25	17	
	Maximum (mbar)					35	45	25	

- * At 15°C and 1013 mbar- dry gas
- ** Propane P.C.S. = 50,37 MJ/Kg
- *** Butane P.C.S. = 49,47 MJ/Kg
- Natural P.C.S. = 37,78 MJ/m³



START-UP AND USE

Using the hob

Lighting the burners

For each BURNER knob there is a complete ring showing the strength of the flame for the relevant burner.

To light one of the burners on the hob:

1. Press the BURNER knob and turn it in an anticlockwise direction so that it is pointing to the maximum flame setting .
2. Adjust the intensity of the flame to the desired level by turning the BURNER knob in an anticlockwise direction. This may be the minimum setting , the maximum setting  or any position in between the two.

If the appliance is fitted with an electronic lighting device* (see figure), press the ignition button, marked with the symbol  then hold the BURNER knob down and turn it in an anticlockwise direction, towards the maximum flame setting, until the burner is lit.

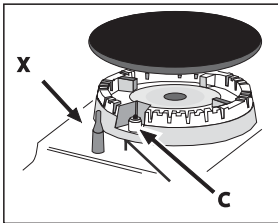

Several models are equipped with an ignition device which is built into the knob; in this case the electronic ignition device* is present (see figure) but the ignition button is not. Simply press the BURNER knob and turn it in an anticlockwise direction so that it is pointing to the maximum flame setting, until the burner is lit. The burner may be extinguished when the knob is released. If this occurs, repeat the operation, holding the knob down for a longer period of time.

! If the flame is accidentally extinguished, switch off the burner and wait for at least 1 minute before attempting to relight it.

If the appliance is equipped with a flame failure safety device*, press and hold the BURNER knob for approximately 2-3 seconds to keep the flame alight and to activate the device.

To switch the burner off, turn the knob until it reaches the stop position .

Flame adjustment according to levels

the burner flame intensity can be adjusted with the knob according to 6 power levels, from maximum to minimum with 4 intermediate positions:



a click will indicate the change from one level to another when turning the knob. The system

guarantees a more precise adjustment, allows to replicate the flame intensity and to identify easily the preferred level for different cooking operations.

Practical advice on using the burners

For the burners to work in the most efficient way possible and to save on the amount of gas consumed, it is recommended that only pans that have a lid and a flat base are used. They should also be suited to the size of the burner.

Burner	ĭ Cookware diameter (cm)
Fast (R)	24 - 26
Semi Fast (S)	16 - 20
Auxiliary (A)	10 - 14

To identify the type of burner, please refer to the diagrams contained in the "Burner and nozzle specifications".

Using the oven

! The first time you use your appliance, heat the empty oven with its door closed at its maximum temperature for at least half an hour. Ensure that the room is well ventilated before switching the oven off and opening the oven door. The appliance may emit a slightly unpleasant odour caused by protective substances used during the manufacturing process burning away.
! Never put objects directly on the bottom of the oven; this will avoid the enamel coating being damaged.
Only use position 1 in the oven when cooking with the rotisserie spit.

Lighting the oven

To light the oven burner, bring a flame or gas lighter close to opening F (see figure) and press the OVEN control knob while turning it in an anticlockwise direction until it reaches the MAX position.

If the appliance is fitted with an electronic lighting device* (see figure), press the ignition button, marked with the symbol , then hold the OVEN control knob and turn it in an anticlockwise direction, towards the MAX position, until the burner is lit. If, after 15 seconds, the burner is still not alight, release the knob, open the oven door and wait for at least 1 minute before trying to light it again. If there is no electricity the burner may be lit using a flame or a lighter, as described above.

! The oven is fitted with a safety device and it is therefore necessary to hold the OVEN control knob down for approximately 6 seconds.

! If the flame is accidentally extinguished, switch off the burner and wait for at least 1 minute before attempting to relight the oven.

Adjusting the temperature

To set the desired cooking temperature, turn the OVEN control knob in an anticlockwise direction. Temperatures are displayed on the control panel and may vary between MIN (145°C) and MAX (240°C). Once the set temperature has been reached, the oven will keep it constant by using its thermostat.

Conventional Oven	
Gas mark	°C
MIN	MIN
1	145
2	150
3	160
4	170
5	180
6	190
7	200
8	210
9	220
10	230
MAX	240

Grill

To light the grill, press the OVEN control knob while turning it in a clockwise direction until it reaches the [▼▼], position. The grill enables the surface of food to be browned evenly and is particularly suitable for roast dishes, schnitzel and sausages. Place the rack in position 4 or 5 and the dripping pan in position 1 to collect fat and prevent the formation of smoke.

! The grill is fitted with a safety device and it is therefore necessary to hold the OVEN control knob down for approximately 6 seconds.

! If the flame is accidentally extinguished, switch off the burner and wait for at least 1 minute before attempting to relight the grill.

! When using the grill, leave the oven door ajar, positioning the deflector D between the door and the control panel (see figure) in order to prevent the knobs from overheating.

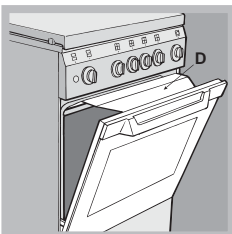

Oven light

The light may be switched on at any moment by pressing the OVEN LIGHT button.

Timer*

To activate the Timer proceed as follows:

1. Turn the TIMER knob in a clockwise direction ↻ for almost one complete revolution to set the buzzer.
2. Turn the TIMER knob in an anticlockwise direction ↺ to set the desired length of time.

Lower compartment*

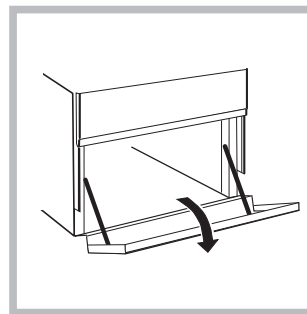

There is a compartment underneath the oven that may be used to store oven accessories or deep dishes. To open the door pull it downwards (see figure).

! The internal surfaces of the compartment (where present) may become hot.

! Do not place flammable materials in the lower oven compartment.

In gas cooker models, there is a sliding protection layer A that shields the lower compartment from the heat generated by the burner (see figure).

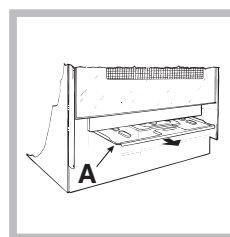

To remove the sliding protection remove the screw S (see figure). To replace it, lock it in place with the screw S.

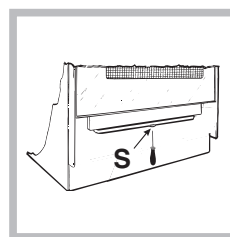

! Before using the oven make sure that the sliding protection is fixed correctly.

* Only available in certain models.

OVEN COOKING ADVICE TABLE

Food to be cooked	Wt. (Kg)	Cooking position of shelves from bottom	Temperature (°C)	Pre-heating time (min)	Cooking time (min.)
Pasta					
Lasagne	2.5	2	200-210	10	75-85
Cannelloni	2.5	2	200	10	50-60
Pasta bakes au gratin	2.5	2	200	10	50-60
Meat					
Veal	1.5	3	200-210	10	95-100
Chicken	1.5	3	210-220	10	90-100
Duck	1.8	3	200	10	100-110
Rabbit	2.0	3	200	10	70-80
Pork	2.1	3	200	10	70-80
Lamb	1.8	3	200	10	100-105
Fish					
Mackerel	1.1	3	180-200	10	45-50
Dentex	1.5	3	180-200	10	45-55
Trout baked in paper	1.0	3	180-200	10	45-50
Pizza					
Napolitan	1.0	4	210-220	15	20-25
Cake					
Biscuits	0.5	4	180	15	25-35
Tarts	1.1	4	180	15	40-45
Savoury pie	1.0	4	180	15	50-55
Raised Cakes	1.0	4	170	15	40-45
Grill cooking					
Veal steaks	1	4		5	15-20
Cutlets	1,5	4		5	20
Hamburgers	1	3		5	20-30
Mackerels	1	4		5	15-20
Toast sandwiches	n.° 4	4		5	4-5

NB: cooking times are approximate and may vary according to personal taste. When cooking using the grill, the dripping-pan must always be placed on the 1st oven rack from the bottom.

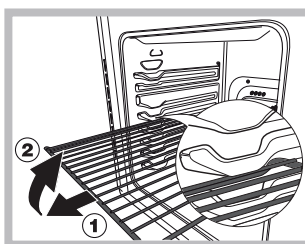

WARNING! The oven is provided with a stop system to extract the racks and prevent them from coming out of the oven. (1) As shown in the drawing, to extract them completely, simply lift the racks, holding them on the front part, and pull (2).

EN

MAINTENANCE AND CLEANING

Respecting and conserving the environment

- Whenever possible, avoid pre-heating the oven and always try to fill it. Open the oven door as little as possible because heat is lost every time it is opened. To save a substantial amount of energy, simply switch off the oven 5 to 10 minutes before the end of your planned cooking time and use the heat the oven continues to generate.
- Keep gaskets clean and tidy to prevent any door energy losses
- If you have a timed tariff electricity contract, the “delay cooking” option will make it easier to save money by moving operation to cheaper time periods.
- The base of your pot or pan should cover the hot plate. If it is smaller, precious energy will be wasted and pots that boil over leave encrusted remains that can be difficult to remove.
- Cook your food in closed pots or pans with well-fitting lids and use as little water as possible. Cooking with the lid off will greatly increase energy consumption
- Use purely flat pots and pans
- If you are cooking something that takes a long time, it's worth using a pressure cooker, which is twice as fast and saves a third of the energy.

Switching the appliance off

Disconnect your appliance from the electricity supply before carrying out any work on it.

Inspecting the oven seals

Check the door seals around the oven periodically. If the seals are damaged, please contact your nearest Authorised After-sales Service Centre. We recommend that the oven is not used until the seals have been replaced.

Gas tap maintenance

Over time, the taps may become jammed or difficult to turn. If this occurs, the tap must be replaced.

! This procedure must be performed by a qualified technician who has been authorised by the manufacturer.

Replacing the oven light bulb

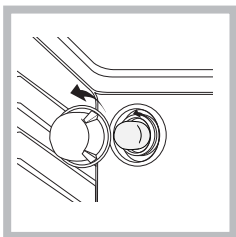

1. After disconnecting the oven from the electricity mains, remove the glass lid covering the lamp socket (see figure).
2. Remove the light bulb and replace it with a similar one: voltage 230 V, wattage 25 W, cap E 14.

3. Replace the lid and reconnect the oven to the electricity supply.

! Do not use the oven lamp as/for ambient lighting.

Assistance

Please have the following information handy:

- The appliance model (Mod.).
- The serial number (S/N).

This information can be found on the data plate located on the appliance and/or on the packaging.

AFTER-SALES SERVICE

To receive assistance, call the number given on the warranty leaflet enclosed with the product or follow the instructions on our website. Be prepared to provide:

- a brief description of the problem;
- the exact model type of your product;
- the assistance code (the number following the word SERVICE on the identification plate attached to the product, which can be seen on the inside edge when the oven door is open);
- your full address;
- a contact telephone number.

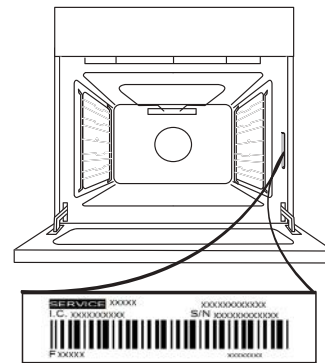

Please note: If repairs are required, contact an authorised service centre that is guaranteed to use original spare parts and perform repairs correctly.

Please refer to the enclosed warranty leaflet for more information on the warranty.

REMOVING AND REFITTING THE DOOR

1. To remove the door, open it fully and lower the catches until they are in the unlock position.

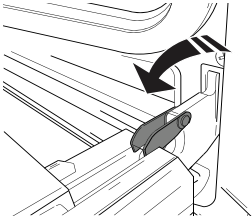

2. Close the door as much as you can. Take a firm hold of the door with both hands – do not hold it by the handle. Simply remove the door by continuing to close it while pulling it upwards (a) at the same time until it is released from its seating (b).

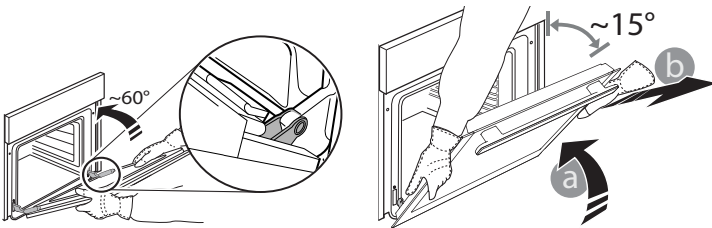

Put the door to one side, resting it on a soft surface.

3. Refit the door by moving it towards the oven, aligning the hooks of the hinges with their seating and securing the upper part onto its seating.

4. Lower the door and then open it fully. Lower the catches into their original position: Make sure that you lower them down completely.

5. Try closing the door and check to make sure that it lines up with the control panel. If it does not, repeat the steps above.

CLICK TO CLEAN - CLEANING THE GLASS

1. After removing the door and resting it on a soft surface with the handle downwards, simultaneously press the two retaining clips and remove the upper edge of the door by pulling it towards you.

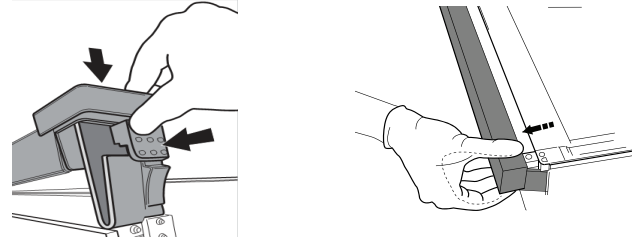

2. Lift and firmly hold the inner glass with both hands, remove it and place it on a soft surface before cleaning it.

3. When reassembling the inner door glass insert the glass panel correctly so that the text written on the panel is not reversed and can be easily legible.

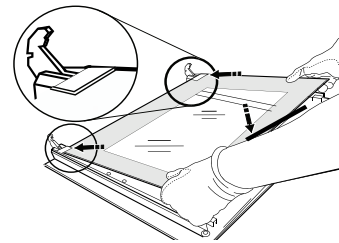

4. Refit the upper edge: a click will indicate correct positioning. Make sure the seal is secure before refitting the door.

Product Guarantee and Repair Information

Guarantee

12 Months Parts and Labour Guarantee

Your appliance has benefit of our manufacturer's guarantee, which covers the cost of breakdown repairs for twelve months from the date of purchase. This gives you the reassurance that if, within that time, your appliance is proven to be defective because of either workmanship or materials, we will, at our discretion, either repair or replace the appliance at no cost to you:

This guarantee is subject to the following conditions:

- The appliance has been installed and operated correctly and in accordance with our operating and maintenance instructions.
- The appliance is used only on the electricity or gas supply printed on the rating plate.
- The appliance has been used for normal domestic purposes only.
- The appliance has not been altered, serviced, maintained, dismantled, or otherwise interfered with by any person not authorised by us.
- Any repair work must be undertaken by us or our appointed agent.
- Any parts removed during repair work or any appliance that is replaced become our property.
- The appliance is used in the United Kingdom or Republic of Ireland.

The guarantee does not cover:

- Damage resulting from transportation, improper use, neglect or interference or as a result of improper installation.
- Replacement of any consumable item or accessory. These include but are not limited to: plugs, cables, batteries, light bulbs, fluorescent tubes and starters, covers and filters.
- Replacement of any removable parts made of glass or plastic.

THIS GUARANTEE WILL NOT APPLY IF THE APPLIANCE HAS BEEN USED IN COMMERCIAL OR NON-DOMESTIC PREMISES.

Recycling and Disposal Information

As part of Hotpoint's continued commitment to helping the environment, Hotpoint reserves the right to use quality, recycled components to keep down customer costs and minimise material wastage.

Please dispose of packaging and old appliances carefully. To minimise the risk of injury to children, remove the door, plug, and cut the mains cable off flush with the appliance. Dispose of these parts separately to ensure that the appliance can no longer be plugged into mains socket, and the door cannot be locked shut.

Repairs and After Sales

For product help and advice, repairs, spare parts or accessories, we're here to help.

For local repair engineers - **03448 111 606**

ROI - **0818 313 413**

UK standard local rate applies

ROI local Irish rate applies

For Parts and Accessories visit:

parts.hotpoint.co.uk/shop

Please remember to register your appliance at **www.hotpointservice.co.uk** to activate your 10 year parts guarantee.

Please note, our advisors will require the following information:

Model number:

Serial number:

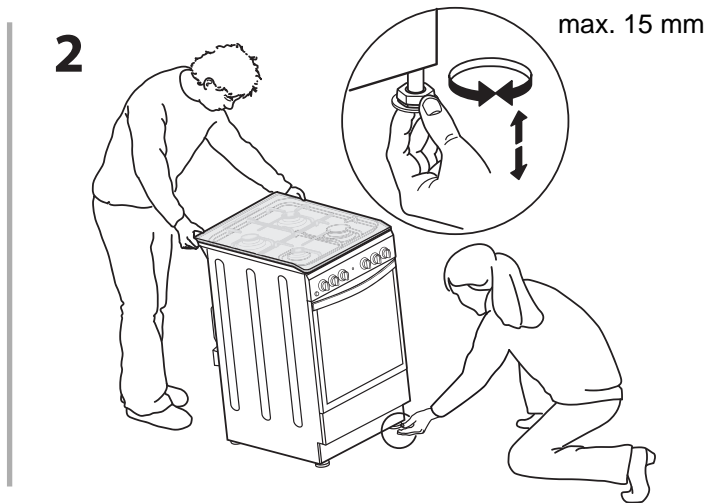
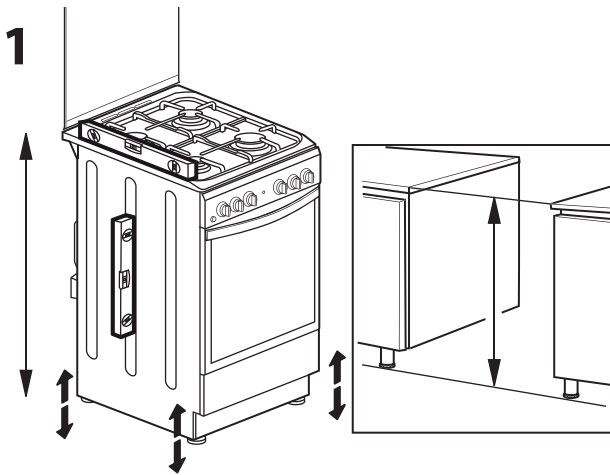
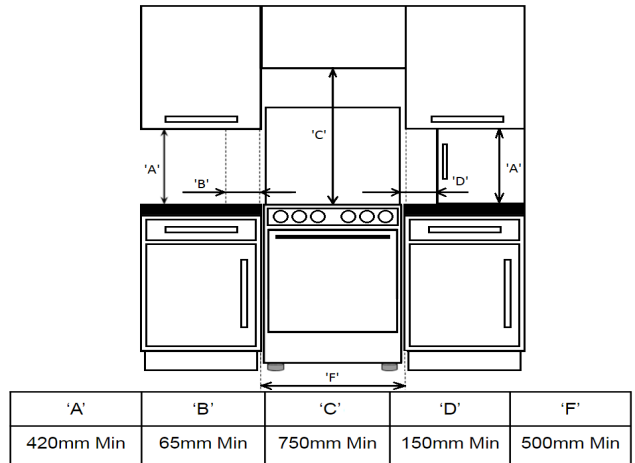
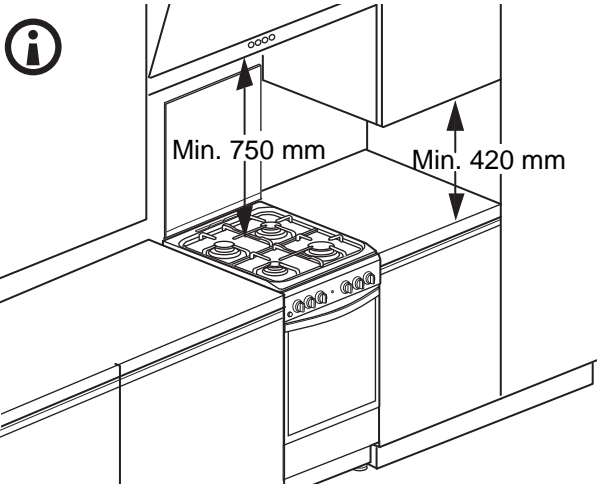
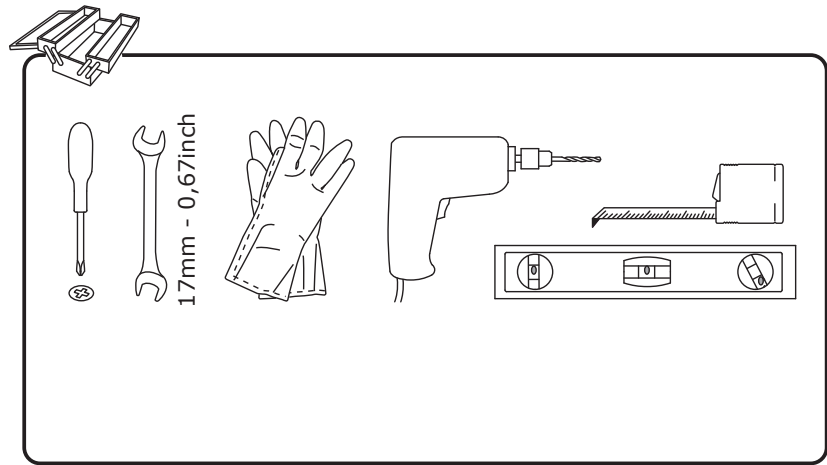
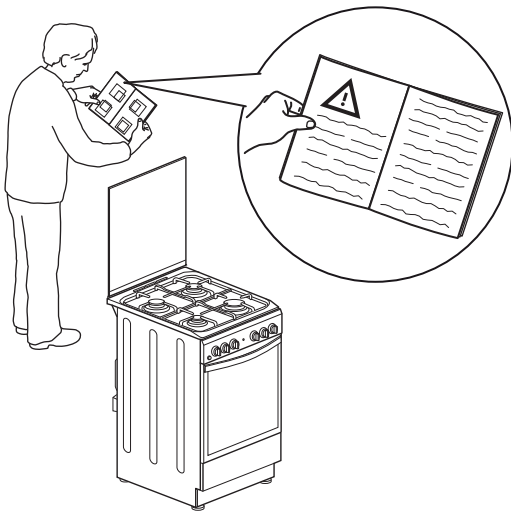

3

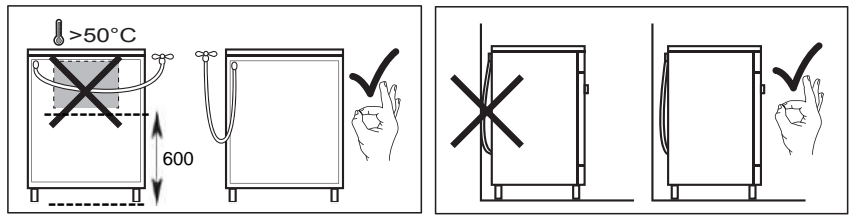
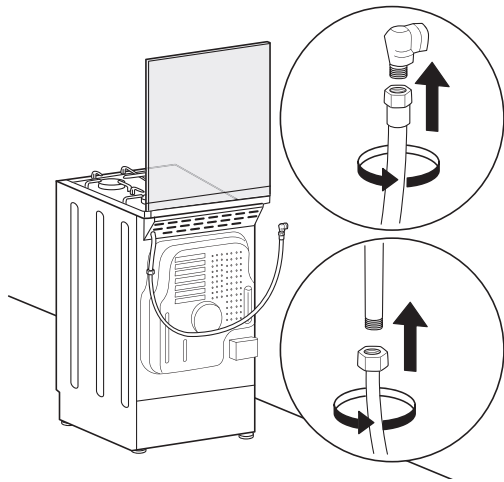

Connecting to gas supply

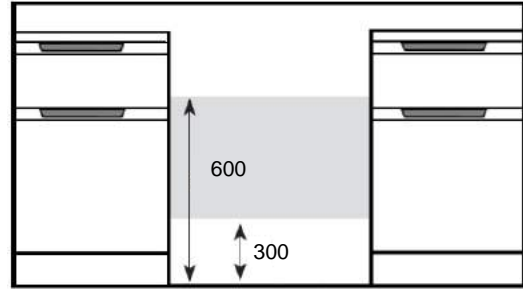

Gas hose connection point must be installed within the shaded area

4

