

BG Ръководство за потребителя и поддръжка

SR Uputstvo za upotrebu i održavanje



SENSING THE DIFFERENCE

IMPORTANT SAFETY INSTRUCTIONS

These instructions shall also be available on website: www.whirlpool.eu

YOUR SAFETY AND THAT OF OTHERS IS VERY IMPORTANT

This manual and the appliance itself provide important safety warnings, to be read and observed at all times.



This is the danger symbol, pertaining to safety, which alerts users to potential risks to themselves and others. All safety warnings are preceded by the danger symbol and the following terms:

! DANGER

Indicates a hazardous situation which, if not avoided, will cause serious injury.

! WARNING

Indicates a hazardous situation which, if not avoided, could cause serious injury.

All safety warnings give specific details of the potential risk present and indicate how to reduce risk of injury, damage and electric shock resulting from improper use of the appliance. Carefully observe the following instructions:

- Use protective gloves to perform all unpacking and installation operations.
- The appliance must be disconnected from the power supply before carrying out any installation work.
- Installation and maintenance must be carried out by a qualified technician, in compliance with the manufacturer's instructions and local safety regulations. Do not repair or replace any part of the appliance unless specifically stated in the user manual.
- Power cable replacement must be carried out by a qualified electrician. Contact an authorized service centre.
- Regulations require that the appliance is earthed.
- The power cable must be long enough for connecting the appliance, once fitted in its housing, to the main power supply.
- For installation to comply with current safety regulations, an all-pole disconnect switch with minimum contact gap of 3 mm must be utilized.
- Do not use multiple plug adaptors if the oven is fitted with a plug.
- Do not use extension leads.
- Do not pull the power supply cable.
- The electrical components must not be accessible to the user after installation.

- If the surface of the induction plate is cracked, do not use it and switch off the appliance to avoid the possibility of electric shock (only for models with induction function).
- Do not touch the appliance with any wet part of the body and do not operate it when barefoot.
- This appliance is designed solely for use as a domestic appliance for cooking food. No other type of use is permitted (e.g.: heating rooms). The Manufacturer declines all responsibility for inappropriate use or incorrect setting of the controls.
- The appliance and its accessible parts become hot during use. Care should be taken to avoid touching heating elements. Very young (0-3 years) and young children (3-8 years) shall be kept away unless continuously supervised.
- Children from 8 years and above and persons with reduced physical, sensory or mental capabilities or lack of experience and knowledge can use this appliance only if they are supervised or have been given instructions on safe appliance use and if they understand the hazards involved. Children shall not play with the appliance. Cleaning and user maintenance shall not be made by children without supervision.
- During and after use, do not touch the heating elements or interior surfaces of the appliance - risk of burns. Do not allow the appliance to come into contact with cloths or other flammable materials until all the components have cooled down completely.
- At the end of cooking, exercise caution when opening the appliance door, letting the hot air or steam exit gradually before accessing the oven. When the appliance door is shut, hot air is vented from the aperture above the control panel. Do not obstruct the vent apertures.
- Use oven gloves to remove pans and accessories, taking care not to touch the heating elements.
- Do not place flammable materials in or near the appliance: a fire may break out if the appliance is inadvertently switched on.
- Do not heat or cook sealed jars or containers in the appliance. The pressure that builds up inside might cause the jar to explode, damaging the appliance.

- Do not use containers made of synthetic materials.
- Overheated oils and fats catch fire easily. Always remain vigilant when cooking foods rich in fat and oil.
- Never leave the appliance unattended during food drying.
- If alcoholic beverages are used when cooking foods (e.g. rum, cognac, wine), remember that alcohol evaporates at high temperatures. As a result, there is a risk that vapours released by the alcohol may catch fire upon coming into contact with the electrical heating element.
- Never use steam cleaning equipment.
- Do not touch the oven during the pyrolysis cycle. Keep children away from the oven during the pyrolysis cycle. Excess spillage must be removed from the oven cavity before cleaning cycle (only for ovens with Pyrolysis function).
- Only use the temperature probe recommended for this oven.
- Do not use harsh abrasive cleaners or sharp metal scrapers to clean the oven door glass since they can scratch the surface, which may result in shattering of the glass.
- Ensure that the appliance is switched off before replacing the lamp to avoid the possibility of electric shock.
- Do not use aluminium foil to cover food in the cooking vessel (only for ovens with cooking vessel supplied).

Scrapping of household appliances

- This appliance is manufactured with recyclable or reusable materials. Dispose of it in accordance with local waste disposal regulations. Before scrapping, cut off the power supply cable.
- For further information on the treatment, recovery and recycling of household electrical appliances, contact your competent local authority, the collection service for household waste or the store where you purchased the appliance.

INSTALLATION

After unpacking the oven, make sure that it has not been damaged during transport and that the oven door closes properly. In the event of problems, contact the dealer or your nearest After-sales Service. To prevent any damage, only remove the oven from its polystyrene foam base at the time of installation.

PREPARING THE HOUSING UNIT

- Kitchen units in contact with the oven must be heat resistant (min 90°C).
- Carry out all cabinet cutting work before fitting the oven in the housing and carefully remove all wood chips and sawdust.
- After installation, the bottom of the oven must no longer be accessible.
- For correct appliance operation, do not obstruct the minimum gap between the worktop and the upper edge of the oven.

ELECTRICAL CONNECTION

Make sure the power voltage specified on the appliance dataplate is the same as the mains voltage. The dataplate is on the front edge of the oven (visible when the door is open).

- Power cable replacement (type H05 RR-F 3 x 1.5 mm²) must be carried out by a qualified electrician. Contact an authorized service centre.

GENERAL RECOMMENDATIONS

Before use:

- Remove cardboard protection pieces, protective film and adhesive labels from accessories.
- Remove the accessories from the oven and heat it at 200°C for about an hour to eliminate the smell and fumes from the insulating materials and protective grease.

During use:

- Do not place heavy objects on the door as they could damage it.
- Do not cling to the door or hang anything from the handle.
- Do not cover the inside of the oven with aluminium foil.
- Never pour water into the inside of a hot oven; this could damage the enamel coating.
- Never drag pots or pans across the bottom of the oven as this could damage the enamel coating.
- Make sure that the electrical cables of other appliances do not touch hot parts of the oven or become trapped in the door.
- Do not expose the oven to atmospheric agents.

SAFEGUARDING THE ENVIRONMENT

Disposal of packing material

The packing material is 100% recyclable and is marked with the recycle symbol (♻️). The various parts of the packing must therefore be disposed of responsibly and in full compliance with local authority regulations governing waste disposal.

Scrapping the product

- This appliance is marked in compliance with European Directive 2002/96/EC, Waste Electrical and Electronic Equipment (WEEE).
- By ensuring this product is disposed of correctly, you will help prevent potential negative consequences for the environment and human health, which could otherwise be caused by inappropriate waste handling of this product.
- The symbol  on the product or on the accompanying documentation indicates that it should not be treated as domestic waste but must be taken to an appropriate collection centre for the recycling of electrical and electronic equipment.

Energy saving tips

- Only pre-heat the oven if specified in the cooking table or your recipe.
- Use dark lacquered or enamelled baking moulds as they absorb heat far better.
- Switch the oven off 10/15 minutes before the set cooking time. Food requiring prolonged cooking will continue to cook even once the oven is switched off.

DECLARATION OF CONFORMITY (C E)

- This oven, which is intended to come into contact with foodstuffs, complies with European Regulation (C E) n.1935/2004 and has been designed, manufactured and sold in conformity with the safety requirements of the "Low Voltage" directive 2006/95/CE (which replaces 73/23/CEE and subsequent amendments), the protection requirements of "EMC" 2004/108/CE.
- This Appliance meets the eco design requirements of European regulations n. 65/2014, and n. 66/2014 in conformity to the European standard EN 60350-1.

TROUBLESHOOTING GUIDE

The oven does not work:

- Check for the presence of mains electrical power and if the oven is connected to the electrical supply.
- Turn off the oven and restart it to see if the fault persists.

The door will not open:

- Turn off the oven and restart it to see if the fault persists.
- **Important:** during self-cleaning, the oven door will not open. Wait until it unlocks automatically (see paragraph "Cleaning cycle of ovens with pyrolysis function").

The electronic programmer does not work:

- If the display shows the letter "F" followed by a number, contact your nearest After-sales Service. Specify in this case the number that follows the letter "F".

AFTER-SALES SERVICE

Before calling the After-Sales Service:

1. See if you can solve the problem yourself with the help of the suggestions given in the "Troubleshooting guide".
2. Switch the appliance off and back on again to see if the fault persists.

If after the above checks the fault still occurs, get in touch with the nearest After-sales Service.

Always specify:

- a brief description of the fault;
- the type and exact model of the oven;
- the service number (number after the word Service on the rating plate), located on the right hand edge of the oven cavity (visible when the oven door is open). The service number is also indicated on the guarantee booklet;
- your full address;
- your telephone number.

SERVICE 0000 000 00000



If any repairs are required, please contact an authorised **After-sales Service** (to guarantee that original spare parts will be used and repairs carried out correctly).

CLEANING



WARNING

- **Never use steam cleaning equipment.**
- **Only clean the oven when it is cool to the touch.**
- **Disconnect the appliance from the power supply.**

Oven exterior

IMPORTANT: do not use corrosive or abrasive detergents. If any of these products accidentally comes into contact with the appliance, clean immediately with a damp microfibre cloth.

- Clean the surfaces with a damp microfibre cloth. If it is very dirty, add a few drops of washing up detergent to the water. Finish off with a dry cloth.

Oven interior

IMPORTANT: do not use abrasive sponges or metallic scrapers or scourers. Over time, these can ruin enamelled surfaces and the oven door glass.

- After every use, allow the oven to cool then clean it preferably while it is still warm in order to remove built-up dirt and stains caused by food residues (e.g. food with a high sugar content).
- Use proprietary oven detergents and follow the manufacturer's instructions to the letter.
- Clean the door glass with a suitable liquid detergent. The oven door can be removed to facilitate cleaning (see MAINTENANCE).
- The top heating element of the grill (see MAINTENANCE) can be lowered (some models only) to clean the roof of the oven.

N.B.: during prolonged cooking of foods with a high water content (e.g. pizza, vegetables, etc.) condensation may form on the inside of the door and around the seal. When the oven is cold, dry the inside of the door with a cloth or sponge.

Accessories:

- Soak the accessories in water with washing up detergent immediately after use, handling them with oven gloves if still hot.
- Food residues can be easily removed using a brush or sponge.

Cleaning the rear wall and catalytic side panels of the oven:

IMPORTANT: do not use corrosive or abrasive detergents, coarse brushes, pot scourers or oven sprays which could damage the catalytic surface and ruin its self-cleaning properties.

- Operate the oven empty with the fan-assisted function at 200°C for about one hour.
- Next, leave the appliance to cool down before removing any food residue with a sponge.

MAINTENANCE

WARNING

- Use protective gloves.
- Ensure the oven is cold before carrying out the following operations.
- Disconnect the oven from the power supply.

REMOVING THE DOOR

To remove the door:

1. Open the door fully.
2. Lift the catches and push them forwards as far as they will go (Fig. 1).
3. Close the door as far as it will go (A), lift it up (B) and turn it (C) until it is released (D) (Fig. 2).

To refit the door:

1. Insert the hinges in their seats.
2. Open the door fully.
3. Lower the two catches.
4. Close the door.

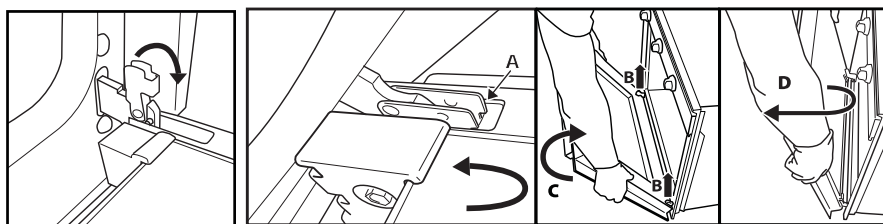

Fig. 1

Fig. 2

MOVING THE TOP HEATING ELEMENT (SOME MODELS ONLY)

1. Remove the side accessory holder grilles (Fig. 3).
2. Pull the heating element out a little (Fig. 4) and lower it (Fig. 5).
3. To reposition the heating element, lift it up, pulling it slightly towards you, making sure it comes to rest on the lateral supports.

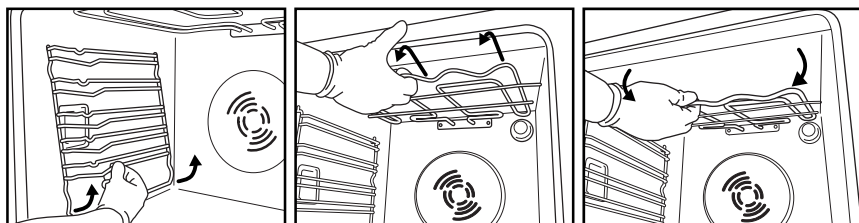

Fig. 3

Fig. 4

Fig. 5

REPLACING THE OVEN LAMP

To replace the rear lamp (if present):

1. Disconnect the oven from the power supply.
2. Unscrew the lamp cover (Fig. 6), replace the lamp (see note for lamp type) and screw the lamp cover back on.
3. Reconnect the oven to the power supply.

To replace the side lamp (if present):

1. Disconnect the oven from the power supply.
2. Remove the side accessory holder grilles, if present (Fig. 3).
3. Use a screwdriver to prise off the lamp cover (Fig. 7).
4. Replace the lamp (see note for lamp type) (Fig. 8).
5. Reposition the lamp cover, pushing it on firmly until it snaps into place (Fig. 9).
6. Refit the side accessory holder grilles.
7. Reconnect the oven to the power supply.

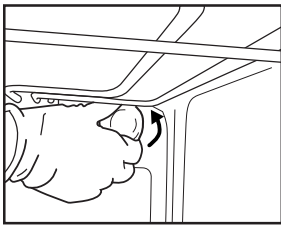

Fig. 6

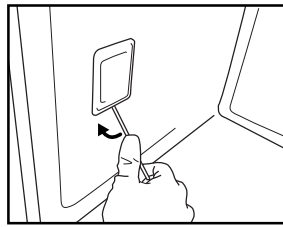

Fig. 7

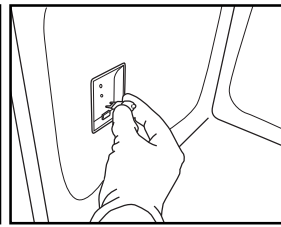

Fig. 8

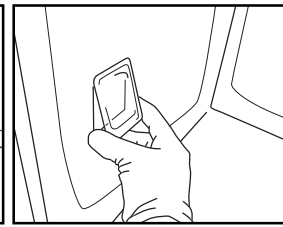

Fig. 9

N.B.:

- Only use 25-40W/230V type E-14, T300°C incandescent lamps, or 20-40W/230 V type G9, T300°C halogen lamps.
- The lamp used in the appliance is specifically designed for electrical appliances and is not suitable for household room illumination (Commission Regulation (EC) No 244/2009).
- Lamps are available from our After-sales Service.

IMPORTANT:

- **If using halogen lamps, do not handle with bare hands since fingerprints can damage them.**
- **Do not use the oven until the lamp cover has been repositioned.**

INSTRUCTIONS FOR OVEN USE

FOR ELECTRICAL CONNECTION, SEE THE PARAGRAPH ON INSTALLATION

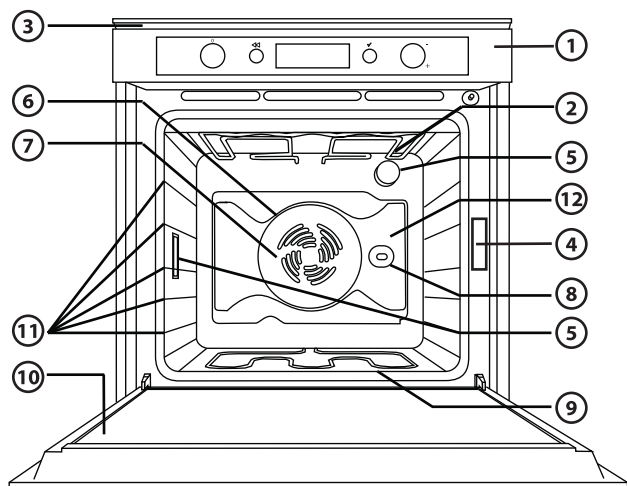

1. Control panel
2. Upper heating element/grill
3. Cooling fan (not visible)
4. Dataplate (not to be removed)
5. Lamps
6. Circular heating element (not visible)
7. Fan
8. Turnspit (if present)
9. Lower heating element (not visible)
10. Door
11. Position of shelves (the number of shelves is indicated on the front of the oven)
12. Rear wall

N.B.:

- During cooking, the cooling fan may switch on at intervals in order to minimise energy consumption.
- At the end of cooking, after the oven has been switched off, the cooling fan may continue to run for a while.
- When the oven door is opened during cooking, the heating elements switch off.

ACCESSORIES SUPPLIED

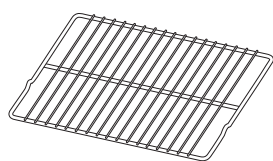

Fig. A

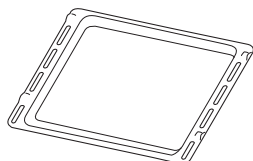

Fig. B

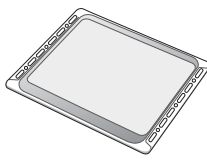

Fig. C

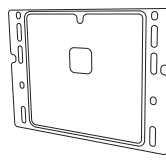

Fig. D



Fig. E

- A. WIRE SHELF:** the wire shelf can be used to grill food or as a support for pans, cake tins and other ovenproof cooking receptacles.
- B. DRIP TRAY:** the drip tray is designed to be positioned under the wire shelf in order to collect fat or as an oven tray for cooking meat, fish, vegetables, focaccia, etc.
- C. BAKING TRAY:** for cooking all bread and pastry products, but also roasts, fish en papillotte, etc.
- D. CATALYTIC PANELS:** for easier and more thorough cleaning of the oven walls.
- E. SLIDING RUNNERS:** to facilitate insertion and removal of accessories.

The number of accessories may vary according to which model is purchased.

ACCESSORIES NOT SUPPLIED

Other accessories can be purchased separately from the After-sales Service.

INSERTING WIRE SHELVES AND OTHER ACCESSORIES IN THE OVEN

1. Insert the wire shelf horizontally, with the raised part "A" upwards (Fig. 1).
2. The other accessories, like the drip tray and baking tray, are inserted with the raised part on the flat section "B" facing upwards (Fig. 2).

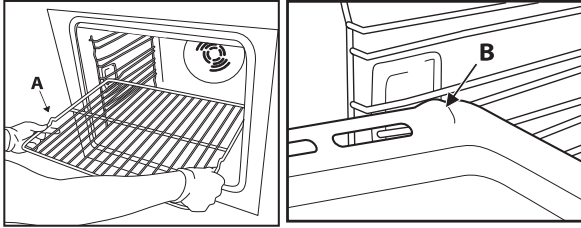
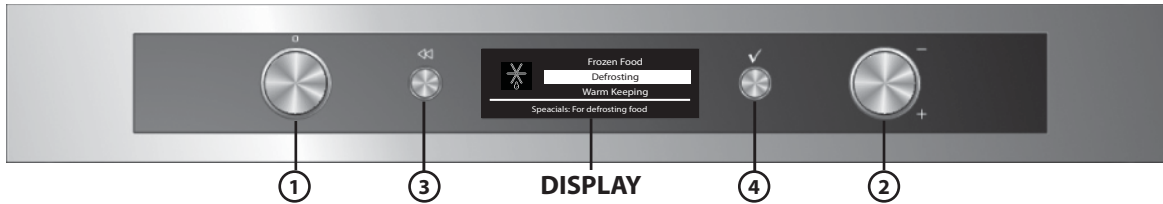

Fig. 1

Fig. 2

CONTROL PANEL DESCRIPTION

ELECTRONIC PROGRAMMER



1. **FUNCTION SELECTOR KNOB:** on/off and function selector knob
 2. **BROWSE KNOB:** for browsing the menu and adjusting pre-set values
- N.B.: the two knobs are retractable. Press the knobs in the middle and they pop up.**
3. **BUTTON** (↶): to return to the previous screen
 4. **BUTTON** (✓): to select and confirm settings

LIST OF FUNCTIONS

Turn the "Functions" knob to any position and the oven switches on: the display shows the functions or the associated submenus.

The submenus are available and selectable by turning the knob to the functions GRILL, SPECIALS, SETTINGS, RECIPES and SHORTCUTS.

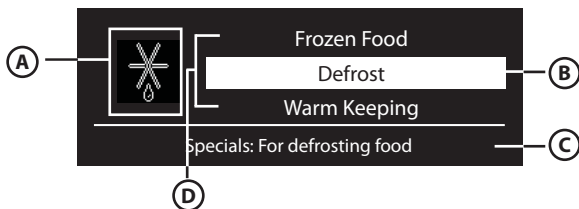

- A. Symbol for highlighted function
- B. Highlighted function can be selected by pressing (✓)
- C. Description of highlighted function
- D. Other available and selectable functions.

DETAILS OF FUNCTION

After selection of the desired function, the display will show further options and related details.

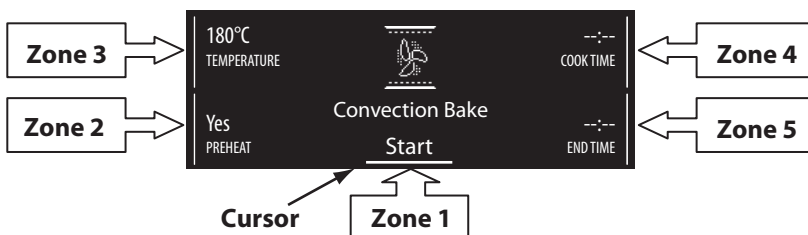

To move between the different areas, turn the "Browse" knob: the cursor moves to the adjustable values, following the order described above. Press button (✓) to select the value, change it by turning the "Browse" knob and confirm with button (✓).

USING THE APPLIANCE FOR THE FIRST TIME - LANGUAGE SELECTION AND SETTING

THE TIME

For correct use of the oven, when it is switched on for the first time you will have to select the desired language and set the correct time.

Proceed as follows:

1. Turn the "Functions" knob to any position: the display will show the list of the first three available languages.
2. Turn the "Browse" knob to scroll the list.
3. When the desired language is highlighted, press to select it. After language selection, the display will flash 12:00.
4. Set the time by turning the "Browse" knob.
5. Confirm your setting by pressing .

SELECTING COOKING FUNCTIONS



1. If the oven is off, turn the "Functions" knob; the display will show the cooking functions or associated submenus.
N.B.: for the list and description of functions, see the specific table at page 14 and at page 15.
2. Within the submenus, browse the various options available by turning the "Browse" knob: the chosen function is highlighted in white in the centre of the screen. To select it, press .
3. the cooking settings are displayed on the screen. If the pre-set values are those desired, turn the "Browse" knob to position the cursor at "Start" and then press ; otherwise, proceed as indicated above to change them.

SETTING THE TEMPERATURE/OUTPUT OF THE GRILL

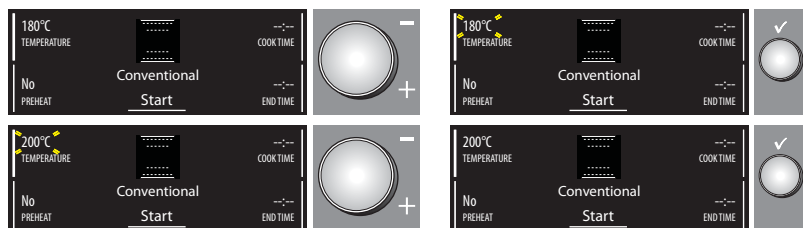

To change the temperature or output of the grill, proceed as follows:

1. Check that the cursor is positioned next to the temperature value (zone 3); press button to select the parameter to be changed: the temperature values flash.
2. Set the desired value by turning the "Browse" knob and press to confirm.
3. Turn the "Browse" knob to position the cursor at "Start" and then press .
4. The display indicates which shelf food should be placed on. Do as instructed and press to start cooking.

The set temperature can also be changed during cooking by following the same procedure.

5. At the end of cooking, the end of cooking message is displayed. At this point the oven can be switched off by turning the "Functions" knob to 0 (zero), or cooking can be prolonged by turning the "Browse" knob clockwise. When switched off, the display shows the cooling bar which indicates the temperature inside the oven.

PREHEATING THE OVEN

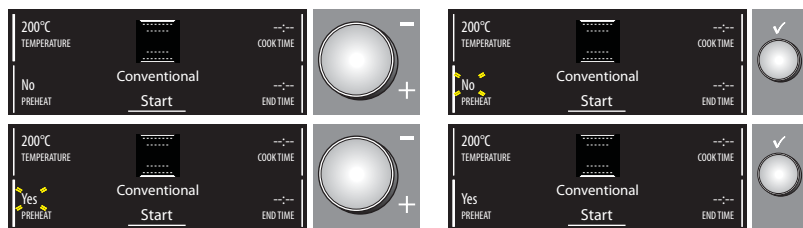

If you wish to preheat the oven before inserting food, change the oven's default selection as follows:

1. Turn the "Browse" knob to position the cursor at preheating.
2. Press button to select the setting: "No" flashes on the display.

3. Change the setting by turning the "Browse" knob: the display shows "Yes".
4. To confirm your choice, press button ✓.

FAST PREHEATING



If you wish to preheat the oven quickly before inserting food, change the oven's default selection as follows:

1. Turn the "Functions" knob to select the fast preheating function.
 2. Confirm by pressing ✓: the settings are displayed on the screen.
 3. If the proposed temperature is that desired, turn the "Browse" knob to position the cursor at "Start" and then press ✓. To change the temperature, proceed as described in previous paragraphs. An acoustic signal will sound when the oven has reached the set temperature. At the end of preheating, the oven automatically selects the conventional function ☐.
- At this point food can be placed in the oven for cooking.
4. If you wish to set a different cooking function, turn the "Functions" knob and select the desired function.

SETTING COOKING TIME

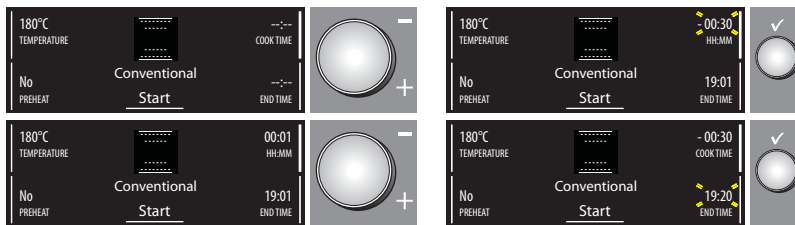

This function can be used to cook food for a set length of time, from a minimum of 1 minute to the maximum time allowed by the selected function, after which the oven switches off automatically.

1. To select the function, turn the "Browse" knob to position the cursor at "COOK TIME".
2. Press button ✓ to select the setting; "00:00" flashes on the display.
3. Change the value by turning the "Browse" knob to display the desired cooking time.
4. Confirm the selected value by pressing button ✓.

BROWNING

At the end of cooking, with certain functions, the display indicates the possibility of browning the surface of your dish. This function can only be used when cooking time has been set.

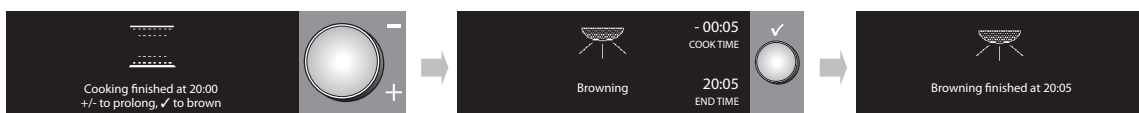

At the end of cooking time, the display shows "+/- to prolong, ✓ to brown". Press button ✓, and the oven starts a 5 minute browning cycle. This function can only be used once after cooking.

SETTING END OF COOKING TIME / DELAYED START

The end of cooking time can be set, delaying the start of cooking by up to a maximum of 23 hours and 59 minutes. This can only be done once cooking time has been set. **This setting is only possible when pre-heating is not required for the selected function.**

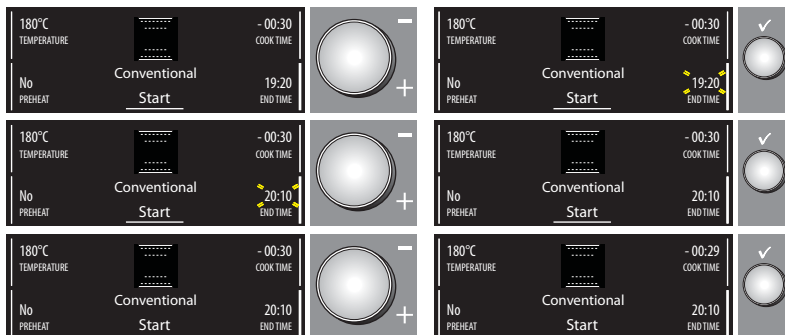

After setting cooking time, the display shows the end of cooking time (for example 19:20). To delay the end of cooking time, and thus also the cooking start time, proceed as follows:

1. Turn the "Browse" knob to position the cursor at the end of cooking time.
2. Press button ✓ to select the setting: the end of cooking time flashes.
3. To delay the end of cooking time, turn the "Browse" knob to set the desired value.
4. Confirm the selected value by pressing button ✓.
5. Turn the "Browse" knob to position the cursor at START and then press ✓.
6. The display indicates which shelf food should be placed on. Do as instructed and press ✓ to start cooking. The oven will start cooking after a period of time calculated so as to finish cooking at the set time (for example, in the case of a dish which requires a cooking time of 20 minutes, if the end of cooking time is set to 20:10, the oven will begin cooking at 19:50).

N.B.: during the interval before cooking starts, the oven can in any case be switched on by turning the "Browse" knob to position the cursor at "Start" and then pressing ✓.

At any time, set values (temperature, grill setting, cooking time) can be changed as described in previous paragraphs.

TIMER

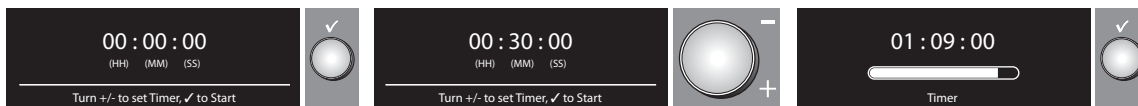

This function can be used only with the oven switched off and is useful, for example, for monitoring the cooking time of pasta. The maximum time which can be set is 1 hour 30 minutes.





1. With the oven switched off, press button ✓: the display will show "00:00:00".
2. Turn the "Browse" knob to select the desired time.
3. Press button ✓ to start the countdown. When the set time has elapsed, the display will show "00:00:00" and an acoustic signal will sound. At this point the time can be prolonged, proceeding as described above, or the timer can be deactivated by pressing button ✓ (the time of day will be shown on the display).

RECIPES

Thanks to "Sixth sense" technology, the oven offers 30 pre-set recipes with ideal cooking temperatures. Simply follow the recipe as regards ingredients and the method of preparation. Then, proceed as follows:



1. Select "RECIPES" by turning the "Functions" knob.
2. Select the dish to be cooked from the proposed list.

3. Confirm the selected dish using button .
4. Select the desired recipe by turning the "Browse" knob.
5. Confirm by pressing : the display shows the approximate cooking time.
6. Place the dish in the oven and turn the "Browse" knob to position the cursor at "Start", then press .
7. The display indicates which shelf food should be placed on. Do as instructed and press  to start cooking. To delay the start of cooking, see the relevant paragraph.

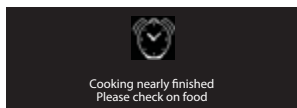
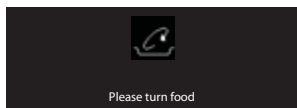



N.B.: some dishes must be turned or stirred half way through cooking: the oven will emit an acoustic signal and the display will indicate what action is required.

The initial cooking time displayed is merely for guidance: it can be prolonged automatically during cooking.

Shortly before cooking time finishes, the oven prompts you to check that the food is cooked to your satisfaction. If it is not, extra time can then be added manually by turning the "Browse" knob.



SETTINGS

1. To change some display settings, select "SETTINGS" from the main menu by turning the "Functions" knob.
2. Confirm by pressing : the display shows which settings can be changed (language, volume of acoustic signal, display brightness, time, energy saving function).
3. Select the setting to be changed by turning the "Browse" knob.
4. Press button  to confirm.
5. Follow the instructions of the display to change the settings.
6. Press button ; a message appears on the display confirming your selection.











N.B.: When the oven is switched off, if the ECOMODE (Energy saving) function is selected (ON), the display switches off after a few minutes, showing the clock. To view information on the display and switch the light on again, just press any of the buttons or turn one of the knobs. During a cooking function if the ECOMODE is activated the cavity lamp will be switched off after 1 minute of cooking and reactivated for each user interaction. If, on the other hand, the function is not selected (OFF), after a few minutes the display is merely dimmed.







KEY-LOCK

This function can be used to lock the buttons and knobs on the control panel.

To activate it, press  and  at the same time for at least 3 seconds. If activated, the functions of the buttons are locked and the display shows a message and the symbol . This function can also be activated during cooking. To deactivate it, repeat the above procedure. When the key-lock function is activated, the oven can be switched off by turning the knob to 0 (zero). In this case, however, the previously selected function will have to be set again.











FUNCTION DESCRIPTION TABLE





FUNCTION SELECTOR KNOB		
	OFF	To halt cooking and switch off the oven.
	LAMP	To switch the oven interior light on/off.
	FAST PREHEATING	To preheat the oven rapidly.
	CONVENTIONAL	To cook any kind of dish on one shelf only. Use the 3rd shelf. To cook pizza, savoury pies and sweets with liquid fillings, use the 1st or 2nd shelf. The oven does not have to be preheated.
	GRILL	To grill steak, kebabs and sausages; to cook vegetables au gratin and toast bread. Place food on the 4th or 5th shelf. When grilling meat, use the drip tray to collect the cooking juices. Position it on the 3rd/4th shelf, adding approx. half a litre of water. The oven does not have to be preheated. During cooking the oven door must remain closed.
	TURBO GRILL	To roast large joints of meat (legs, roast beef, chickens). Position the food on the middle shelves. Use the drip tray to collect the cooking juices. Position it on the 1st/2nd shelf, adding approx. half a litre of water. The oven does not have to be preheated. During cooking the oven door must remain closed. With this function you can also use the turnspit, if provided.
	FORCED AIR	To cook a variety of food requiring the same cooking temperature on several shelves (maximum three) at the same time (e.g. fish, vegetables, cakes). This function can be used to cook different foods without odours being transferred from one food to another. Use the 2nd shelf to cook on one shelf only, the 1st and 4th to cook on two shelves, and the 1st, 3rd and 5th to cook on three shelves. The oven does not have to be preheated.
	CONVECTION BAKE	To cook meat and pies with liquid filling (savoury or sweet) on single shelf. Use 3rd shelf. The oven does not have to be preheated.
	SPECIALS	See SPECIAL FUNCTIONS.
	SETTINGS	Setting the display (language, time, brightness, volume of acoustic signal, energy saving function).
	RECIPES	Selecting 30 different pre-set recipes (see enclosed recipe booklet). The oven automatically sets the optimum cooking temperature, function and time. It is important to follow the instructions given in the recipe book regarding preparation, accessories and which oven shelf to use.
	SHORTCUTS	To directly access the 10 most used functions. To change the settings of the desired function, see paragraph "SELECTING COOKING FUNCTIONS".

SPECIAL			
	DEFROST	To speed up defrosting of food. Place food on the middle shelf. Leave food in its packaging in order to prevent it from drying out on the outside.	
	KEEP WARM	For keeping just-cooked food hot and crisp (e.g: meat, fried food or flans). Place food on the middle shelf. The function will not activate if the temperature in the oven is above 65°C.	
	RISING	For optimal rising of sweet or savoury dough. To safeguard the quality of proving, the function will not activate if the temperature in the oven is above 40°C. Place the dough on the 2nd shelf. The oven does not have to be preheated.	
	CONVENIENCE	Cooking ready meals kept at room temperature or from refrigerated cabinets (biscuits, liquid cake mixtures, muffins, first courses and bakery products). This function gently cooks all food quickly; it can also be used to reheat cooked food. Follow the instructions on the food packaging. The oven does not have to be preheated.	
	MAXI COOKING	To cook large joints of meat (above 2.5 kg). Use the 1st or 2rd shelves, depending on the size of the joint. The oven does not have to be preheated. It is advisable to turn the meat over during cooking, to obtain even browning on both sides. It is preferable to baste the meat every now and again so that it does not become too dry.	
	FROZEN FOOD	Lasagne	The function automatically selects the ideal cooking temperature and mode for 5 different types of ready frozen food. Use the 2nd or 3rd shelf. The oven does not have to be preheated.
		Pizza	
		Strudel	
		French Fries	
		Bread	
	Custom	The temperature can be set from 50 to 250°C to cook other types of product.	
	ECO FORCED AIR	To cook stuffed roasts and meat in pieces on one shelf. This function uses discontinuous, delicate fan assistance, which prevents excessive drying of foods. In this ECO function the light remains off during cooking and can be temporarily switched on again by pressing the confirm button. In order to maximize energy efficiency, it is advisable not to open the door during cooking. It is advisable to use 3rd level. The oven does not have to be preheated.	

COOKING TABLE















Recipe	Function	Pre-heating	Shelf (from bottom)	Temp. (°C)	Time (min)	Accessories and notes
Leavened cakes		-	2/3	160-180	30-90	Cake tin on rack
		-	1-4	160-180	30-90	Level 4: cake tin on rack Level 1: cake tin on rack
Filled pies (cheesecake, strudel, apple pie)		-	3	160-200	35-90	Drip-tray / baking tray or cake tin on rack
		-	1-4	160-200	40-90	Level 4: cake tin on rack Level 1: cake tin on rack
Biscuits / Tartlets		-	3	170-180	20-45	Drip-tray or baking tray
		-	1-4	160-170	20-45	Level 4: rack Level 1: drip-tray or baking tray
		-	1-3-5	160-170	20-45*	Level 5: pan on rack Level 3: pan on rack Level 1: drip-tray or baking tray
		-	1-3-5	160-170	20-45*	Level 5: pan on rack Level 3: pan on rack Level 1: drip-tray or baking tray
Choux buns		-	3	180-200	30-40	Drip-tray or baking tray
		-	1-4	180-190	35-45	Level 4: pan on rack Level 1: drip-tray or baking tray
		-	1-3-5	180-190	35-45*	Level 5: pan on rack Level 3: pan on rack Level 1: drip-tray or baking tray
		-	1-3-5	180-190	35-45*	Level 5: pan on rack Level 3: pan on rack Level 1: drip-tray or baking tray
Meringues		-	3	90	110-150	Drip-tray or baking tray
		-	1-4	90	140-160	Level 4: pan on rack Level 1: drip-tray or baking tray
		-	1-3-5	90	140-160*	Level 5: pan on rack Level 3: pan on rack Level 1: drip-tray or baking tray
		-	1-3-5	90	140-160*	Level 5: pan on rack Level 3: pan on rack Level 1: drip-tray or baking tray
Bread / Pizza / Focaccia		-	1/2	190-250	15-50	Drip-tray or baking tray
		-	1-4	190-250	20-50	Level 4: pan on rack Level 1: drip-tray or baking tray
		-	1-3-5	190-250	25-50*	Level 5: pan on rack Level 3: pan on rack Level 1: drip-tray or baking tray
		-	1-3-5	190-250	25-50*	Level 5: pan on rack Level 3: pan on rack Level 1: drip-tray or baking tray
Savoury pies (vegetable pie, quiche lorraine)		-	2/3	180-190	40-55	Cake tin on rack
		-	1-4	180-190	45-70	Level 4: cake tin on rack Level 1: cake tin on rack
		-	1-3-5	180-190	45-70*	Level 5: cake tin on rack Level 3: cake tin on rack Level 1: drip-tray or baking tray + cake tin
		-	1-3-5	180-190	45-70*	Level 5: cake tin on rack Level 3: cake tin on rack Level 1: drip-tray or baking tray + cake tin

Recipe	Function	Pre-heating	Shelf (from bottom)	Temp. (°C)	Time (min)	Accessories and notes	
Vols-au-vent / Puff pastry savouries		-	3	190-200	20-30	Drip-tray or baking tray	
		-	1-4	180-190	20-40	Level 4: pan on rack Level 1: drip-tray or baking tray	
		-	1-3-5	180-190	20-40*	Level 5: pan on rack Level 3: pan on rack Level 1: drip-tray or baking tray	
		-					
Lasagna / Baked pasta / Cannelloni / Flans		-	3	190-200	45-65	Drip-tray or pan on rack	
Lamb / Veal / Beef / Pork 1 Kg		-	3	190-200	80-110	Drip-tray or pan on rack	
Chicken / Rabbit / Duck 1 Kg		-	3	200-230	50-100	Drip-tray or pan on rack	
Turkey / Goose 3 Kg		-	2	190-200	80-130	Drip-tray or pan on rack	
Baked fish / en papillote (fillet, whole)		-	3	180-200	40-60	Drip-tray or pan on rack	
Stuffed vegetables (tomatoes, courgettes, aubergines)		-	2	180-200	50-60	Pan on rack	
Toast		-	5	High	3-6	Rack	
Fish fillets / steaks		-	4	Medium	20-30	Level 4: rack (turn food halfway through cooking)	
						Level 3: drip-tray with water	
Sausages / Kebabs / Spare ribs / Hamburgers		-	5	Medium-High	15-30	Level 5: rack (turn food halfway through cooking)	
						Level 4: drip-tray with water	
Roast chicken 1-1.3 Kg		-	2	Medium	55-70	Level 2: rack (turn food two thirds of the way through cooking)	
							Level 1: drip-tray with water
			2	High	60-80	Level 2: turnspit (if present) Level 1: drip-tray with water	
Roast beef rare 1 Kg		-	3	Medium	35-50	Pan on rack (turn food two thirds of the way through cooking if necessary)	
Leg of lamb / Shanks		-	3	Medium	60-90	Drip-tray or pan on rack (turn food two thirds of the way through cooking if necessary)	
Baked potatoes		-	3	Medium	45-55	Drip-tray or baking tray (turn food two thirds of the way through cooking if necessary)	
Vegetables au gratin		-	3	High	10-25	Drip-tray or pan on rack	
Lasagna & Meat		-	1-4	200	50-100*	Level 4: pan on rack	
						Level 1: drip-tray or pan on rack	
Meat & Potatoes		-	1-4	200	45-100*	Level 4: pan on rack	
						Level 1: drip-tray or pan on rack	

Recipe	Function	Pre-heating	Shelf (from bottom)	Temp. (°C)	Time (min)	Accessories and notes		
Fish & Vegetables		-	1-4	180	30-50*	Level 4: pan on rack		
						Level 1: drip-tray or pan on rack		
Complete meal: Tart (Level 5) / Lasagna (Level 3) / Meat (Level 1)		-	1-3-5	190	40-120*	Level 5: pan on rack		
						Level 3: pan on rack		
						Level 1: drip-tray or pan on rack		
Frozen pizza		-	3	Auto	10-15	Level 3: drip-tray / baking tray or rack		
		-	1-4	Auto	15-20	Level 4: pan on rack Level 1: drip-tray or baking tray		
		-	1-2-4	Auto	20-30	Level 4: baking tray Level 2: pan on rack Level 1: drip-tray or baking tray		
		-	1-2-3-4	Auto	20-30	Level 4: baking tray Level 3: pan on rack Level 2: pan on rack Level 1: drip-tray / baking tray		
		Filled roast meats		-	3	200	80-120*	Drip-tray or pan on rack
		Meat cuts (rabbit, chicken, lamb)		-	3	200	50-100*	Drip-tray or pan on rack

* Cooking time is approximate. Food can be removed from the oven at different times depending on personal preference.

TESTED RECIPES in compliance with IEC 60350-1:2011-12 and DIN 3360-12:07:07

Recipe	Function	Pre-heating	Shelf (from bottom)	Temp. (°C)	Time (min)	Accessories and notes
IEC 60350-1:2011-12 § 7.5.2						
Shortbread		-	3	170	15-30	Drip-tray / baking tray
		-	1-4	150	25-40	Level 4: baking tray Level 1: drip tray / baking tray
IEC 60350-1:2011-12 § 7.5.3						
Small cakes		-	3	170	25-35	Drip-tray / baking tray
		-	1-4	160	30-40	Level 4: baking tray Level 1: drip tray / baking tray
IEC 60350-1:2011-12 § 7.6.1						
Fatless sponge cake		-	2	170	30-40	Cake tin on rack
		-	1-4	160	35-45	Level 4: cake tin on wire shelf Level 1: cake tin on wire shelf
IEC 60350-1:2011-12 § 7.6.2						
Two apple pies		-	2/3	185	70-90	Cake tin on rack
		-	1-4	175	75-95	Level 4: cake tin on rack Level 1: cake tin on rack
IEC 60350-1:2011-12 § 9.2						
Toast**		-	5	High	3-6	Rack
IEC 60350-1:2011-12 § 9.3						
Burgers**		-	5	High	18-30	Level 5: rack (turn food halfway through cooking) Level 4: drip-tray with water
DIN 3360-12:07 § 6.5.2.3						
Apple cake, yeast tray cake		-	3	180	35-45	Drip-tray / baking tray
		-	1-4	160	55-65	Level 4: baking tray Level 1: drip tray / baking tray
DIN 3360-12:07 § 6.6						
Roast pork		-	2	170	110-150	Level 2: drip-tray
DIN 3360-12:07 annex C						
Flat cake		-	3	170	35-45	Drip-tray / baking tray
		-	1-4	160	40-50	Level 4: baking tray Level 1: drip tray / baking tray

The cooking table suggests the ideal functions and temperatures to ensure the best results with all recipes. If you wish to cook on one shelf only using the fan-assisted function, place food on the second shelf and select the temperature recommended for the "FORCED AIR" function on more than one shelf.

The indications in the table are without use of the runners. Do the tests without the runners.

** When grilling food, it is advisable leave a space of 3-4 cm from the front edge of the grill to facilitate removal

Energy efficiency class (according to EN 60350-1:2013-07)

To do the test, use the dedicated table.

Energy consumption and preheating time

Select the function and do the test only with the "Preheating" option activated ("Preheating yes").

Control Accuracy test

Select the function and do the test only with the "Preheating" option deactivated (when preheating is activated, the oven control intentionally creates an oscillation of the temperature profile).

RECOMMENDED USE AND TIPS

How to read the cooking table

The table indicates the best function to use for any given food, to be cooked on one or more shelves at the same time. Cooking times start from the moment food is placed in the oven, excluding pre-heating (where required). Cooking temperatures and times are purely for guidance and will depend on the amount of food and type of accessory used. Use the lowest recommended values to begin with and, if the food is not cooked enough, then move on to higher values. Use the accessories supplied and preferably dark coloured metal cake tins and oven trays. You can also use pans and accessories in pyrex or stoneware, but bear in mind that cooking times will be slightly longer. To obtain best results, carefully follow the advice given in the cooking table for the choice of accessories (supplied) to be placed on the various shelves.

Cooking different foods at the same time

Using the "FORCED AIR" function, you can cook different foods which require the same cooking temperature at the same time (for example: fish and vegetables), using different shelves. Remove the food which requires less cooking time and leave food which requires longer cooking time in the oven.

Desserts

- Cook delicate desserts with the conventional function on one shelf only. Use dark coloured metal cake tins and always position them on the wire shelf supplied. To cook on more than one shelf, select the forced air function and stagger the position of the cake tins on the shelves, aiding optimum circulation of the hot air.
- To check whether a raising cake is cooked, insert a wooden toothpick into the centre of the cake. If the toothpick comes out clean, the cake is ready.
- If using non-stick cake tins, do not butter the edges as the cake may not rise evenly around the edges.
- If the cake "sinks" during cooking, set a lower temperature the next time, perhaps reducing the amount of liquid in the mixture and mixing more gently.
- For sweets with moist fillings (cheesecake or fruit pies) use the "CONVECTION BAKE" function. If the base of the cake is soggy, lower the shelf and sprinkle the bottom of the cake with breadcrumbs or biscuit crumbs before adding the filling.

Meat

- Use any kind of oven tray or pyrex dish suited to the size of the piece of meat being cooked. For roast joints, it is best to add some stock to the bottom of the pan, basting the meat during cooking for added flavour. When the roast is ready, let it rest in the oven for another 10-15 minutes, or wrap it in aluminium foil.
- When you want to grill meat, choose cuts with an even thickness all over in order to achieve uniform cooking results. Very thick pieces of meat require longer cooking times. To prevent the meat from burning on the outside, lower the position of the wire shelf, keeping the food farther away from the grill. Turn the meat two thirds of the way through cooking.

To collect the cooking juices it is advisable to place a drip-tray with half a litre of water directly under the grill on which the meat is placed. Top-up when necessary.

Turnspit (only in some models)

Use this accessory to evenly roast large pieces of meat and poultry. Place the meat on the spit rod, tying it with string if chicken, and check that it is secure before inserting the rod in the seat located on the front wall of the oven and resting it on the respective support. To prevent smoke and to collect cooking juices, it is advisable to place a drip-tray with half a litre of water on the first level. The rod has a plastic handle which must be removed before starting to cook, and used at the end of cooking to avoid burns when taking the food out of the oven.

Pizza

Lightly grease the trays to ensure the pizza has a crispy base. Scatter the mozzarella over the pizza two thirds of the way through cooking.

Dough proving function

It is always best to cover the dough with a damp cloth before placing it in the oven. Dough proving time with this function is reduced by approximately one third compared to proving at room temperature (20-25°C). Proving time for a 1 Kg batch of pizza dough is around one hour.



Printed in Italy
03/2012

5019 300 03099



Whirlpool® Registered trademark/TM Trademark of Whirlpool, USA